

# ACS550

User's Manual

ACS550-01 Drives (0.75...160 kW)

ACS550-U1 Drives (1...200 hp)



## List of related manuals

### GENERAL MANUALS

---

#### ACS550-01/U1 User's Manual (0.75...160 kW) / (1...200 hp)

3AFE64804588 ([3AUA0000001418](#)) (English)

#### Flange Mounting Instructions

Kit, IP21 / UL type 1	Frame size	Code (English)
FMK-A-R1	R1	<a href="#">10000982</a>
FMK-A-R2	R2	<a href="#">10000984</a>
FMK-A-R3	R3	<a href="#">10000986</a>
FMK-A-R4	R4	<a href="#">10000988</a>
AC8-FLNGMT-R5 <sup>1</sup>	R5	ACS800-
AC8-FLNGMT-R6 <sup>1</sup>	R6	PNTG01U-EN

1. Not available for ACS550-01 series

Kit, IP54 / UL type 12	Frame size	Code (English)
FMK-B-R1	R1	<a href="#">10000990</a>
FMK-B-R2	R2	<a href="#">10000992</a>
FMK-B-R3	R3	<a href="#">10000994</a>
FMK-B-R4	R4	<a href="#">10000996</a>

### OPTION MANUALS

---

(delivered with optional equipment)

#### MFD01 FlashDrop User's Manual

[3AFE68591074](#) (English)

#### OHDI-01 115/230 V Digital Input Module User's Manual

[3AUA0000003101](#) (English)

#### OREL-01 Relay Output Extension Module User's Manual

[3AUA0000001935](#) (English)

#### OTAC-01 User's Manual Pulse Encoder Interface Module User's Manual

[3AUA0000001938](#) (English)

#### RCAN-01 CANopen Adapter User's Manual

[3AFE64504231](#) (English)

#### RCNA-01 ControlNet Adapter User's Manual

[3AFE64506005](#) (English)

#### RDNA-01 DeviceNet Adapter User's Manual

[3AFE64504223](#) (English)

#### RECA-01 EtherCAT Adapter Module User's Manual

[3AUA00000043520](#) (English)

#### REPL-01 Ethernet POWERLINK Adapter Module User's Manual

[3AUA00000052289](#) (English)

#### REPL-02 Ethernet POWERLINK Adapter Module User's Manual

[3AUA00000090411](#) (English)

#### RETA-01 Ethernet Adapter Module User's Manual

[3AFE64539736](#) (English)

#### RETA-02 Ethernet Adapter Module User's Manual

[3AFE68895383](#) (English)

#### RPBA-01 PROFIBUS DP Adapter User's Manual

[3AFE64504215](#) (English)

#### SREA-01 Ethernet Adapter User's Manual

[3AUA00000042896](#) (English)

Typical contents

- Safety
- Installation
- Programming/Start-up
- Diagnostics
- Technical data

### MAINTENANCE MANUALS

---

#### Guide for Capacitor Reforming in ACS50, ACS55, ACS150, ACS310, ACS350, ACS355, ACS550, ACH550 and R1-R4 OINT-/SINT-boards

[3AFE68735190](#) (English)

[ACS550-01 manuals](#)



CANopen is a registered trademark of CAN in Automation e.V.

ControlNet™ is a trademark of ODVA™.

DeviceNet™ is a trademark of ODVA™.

DRIVECOM is a registered trademark of DRIVECOM User Group e.V.

EtherCAT® is registered trademark and patented technology, licensed by Beckhoff Automation GmbH, Germany.

EtherNet/IP™ is a trademark of ODVA™.

ETHERNET POWERLINK is a trademark of Bernecker + Rainer Industrie-ElektronikGes.m.b.H.

Modbus and Modbus/TCP are registered trademarks of Schneider Automation Inc.

PROFIBUS, PROFIBUS DP and PROFINET IO are registered trademarks of Profibus International.

ACS550-01/U1 Drives  
0.75...160 kW  
1...200 hp

## **User's Manual**

3AFE64804588 (3AUA0000001418) Rev H  
EN

EFFECTIVE: 2014-07-04

SUPERSEDES: 3AFE64804588 (3AUA0000001418) Rev G 2009-07-07



# Safety instructions

---

## Use of warnings and notes

There are two types of safety instructions throughout this manual:

- Notes draw attention to a particular condition or fact, or give information on a subject.
- Warnings caution you about conditions which can result in serious injury or death and/or damage to the equipment. They also tell you how to avoid the danger. The warning symbols are used as follows:



**Electricity warning** warns of hazards from electricity which can cause physical injury and/or damage to the equipment.



**General warning** warns about conditions, other than those caused by electricity, which can result in physical injury and/or damage to the equipment.

## General safety



**WARNING!** Obey these instructions. If you ignore them, injury or death, or damage to the equipment can occur.

- Use safety shoes to avoid foot injury.
- Handle the drive carefully.
- Beware of hot surfaces. Some parts, such as heatsinks, remain hot for a while after disconnection of the electrical supply. See chapter [Technical data](#) on page 277.
- Keep the drive in its package or protect it otherwise from dust and burr from drilling and grinding until you install it. Protect also the installed drive against dust and burr. Electrically conductive debris inside the drive can cause damage or malfunction.

## Electrical safety



**WARNING!** The ACS550 adjustable speed AC drive should **ONLY** be installed by a qualified electrician.



**WARNING!** Even when the motor is stopped, dangerous voltage is present at the power circuit terminals U1, V1, W1 and U2, V2, W2 and, depending on the frame size, UDC+ and UDC-, or BRK+ and BRK-.



**WARNING!** Dangerous voltage is present when input power is connected. After disconnecting the supply, wait at least 5 minutes (to let the intermediate circuit capacitors discharge) before removing the cover.

---



**WARNING!** Even when power is switched off from the input terminals of the ACS550, there may be dangerous voltage (from external sources) on the terminals of the relay outputs RO1...RO3.

---



**WARNING!** When the control terminals of two or more drives are connected in parallel, the auxiliary voltage for these control connections must be taken from a single source which can either be one of the drives or an external supply.

---



**WARNING!** If you install the drive on an IT system (an ungrounded power system or a high-resistance-grounded [over 30 ohms] power system), disconnect the internal EMC filter, otherwise the system will be connected to ground potential through the EMC filter capacitors. This can cause danger or damage the drive.

If you install the drive on a corner-grounded TN system, disconnect the internal EMC filter, otherwise the system will be connected to ground potential through the EMC filter capacitors. This will damage the drive.

**Note:** Disconnecting the internal EMC filter increases the conducted emission and reduces the drive EMC compatibility considerably.

See section [Disconnecting the internal EMC filter](#) on page 27. Also see sections [IT systems](#) on page 286 and [Corner-grounded TN systems](#) on page 285.

---



**WARNING!** Do not attempt to install or remove EM1, EM3, F1 or F2 screws while power is applied to the drive's input terminals.

---

## Maintenance





**WARNING!** The ACS550-01/U1 is not field repairable. Never attempt to repair a malfunctioning drive; contact your local ABB representative for replacement.

---

## Control of the drive and motor



**WARNING!** Do not control the motor with the disconnecting device (disconnecting means); instead, use the control panel start and stop keys  and , or commands via the I/O board of the drive. The maximum allowed number of charging cycles of the DC capacitors (i.e. power-ups by applying power) is five in ten minutes.

---



**WARNING!** The ACS550 will start up automatically after an input voltage interruption if the external run command is on.

---

**Note:** For more technical information, contact your local ABB representative.

---





# Table of contents

---

## **List of related manuals**

### **Safety instructions**

Use of warnings and notes .....	5
General safety .....	5
Electrical safety .....	5
Maintenance .....	6
Control of the drive and motor .....	7

### **Table of contents**

#### **Contents of this manual**

Compatibility .....	13
Intended use .....	13
Intended audience .....	13

#### **Installation**

Installation flow chart .....	15
Preparing for installation .....	16
Installing the drive .....	20

#### **Start-up, control with I/O and ID Run**

How to start up the drive .....	37
How to control the drive through the I/O interface .....	44
How to perform the ID Run .....	45

#### **Control panels**

About control panels .....	47
Compatibility .....	47
Assistant Control Panel .....	48
Basic Control Panel .....	68

#### **Application macros**

ABB Standard macro .....	78
3-wire macro .....	79
Alternate macro .....	80
Motor Potentiometer macro .....	81
Hand-Auto macro .....	82
PID Control macro .....	83
PFC macro .....	84
Torque Control macro .....	85
Connection examples of two-wire and three-wire sensors .....	86
Connection for obtaining 0...10 V from analog outputs .....	87
User parameter sets .....	88

Macro default values for parameters .....	89
<b>Parameters</b>	
Complete parameter list .....	91
Complete parameter descriptions .....	106
<b>Embedded fieldbus</b>	
Overview .....	203
Planning .....	204
Mechanical and electrical installation – EFB .....	204
Communication set-up – EFB .....	205
Activate drive control functions – EFB .....	207
Feedback from the drive – EFB .....	211
Diagnostics – EFB .....	212
Modbus protocol technical data .....	215
ABB control profiles technical data .....	224
<b>Fieldbus adapter</b>	
Overview .....	237
Planning .....	239
Mechanical and electrical installation – FBA .....	240
Communication set-up – FBA .....	241
Activate drive control functions – FBA .....	241
Feedback from the drive – FBA .....	244
Diagnostics – FBA .....	245
ABB Drives profile technical data .....	248
Generic profile technical data .....	256
<b>Diagnostics</b>	
Diagnostic displays .....	259
Correcting faults .....	260
Correcting alarms .....	266
<b>Maintenance</b>	
Maintenance intervals .....	271
Heatsink .....	271
Main fan replacement .....	272
Internal enclosure fan replacement .....	274
Capacitors .....	275
Control panel .....	275
<b>Technical data</b>	
Ratings .....	277
Input power connections .....	281
Motor connections .....	289
Brake components .....	295
Control connections .....	299
Efficiency .....	300
Losses, cooling data and noise .....	301

Dimensions and weights .....	303
Degrees of protection .....	306
Ambient conditions .....	307
Materials .....	308
Applicable standards .....	309
Markings .....	309
IEC/EN 61800-3:2004 Definitions .....	311
Compliance with the IEC/EN 61800-3:2004 +A1:2012 .....	311

### ***Index***

#### ***Further information***

Product and service inquiries .....	325
Product training .....	325
Providing feedback on ABB Drives manuals .....	325
Document library on the Internet .....	325



# Contents of this manual

---

## Compatibility

This manual covers ACS550-01/U1 drives. The manual is compatible with the ACS550-01/U1 drive firmware version 3.14e or later. See parameter 3301 FIRMWARE on page [155](#).

## Intended use

The ACS550-01/U1 is a general purpose drive. The macros should only be applied to the applications defined in the respective section.

## Intended audience

This manual is intended for personnel who install, commission, operate and service the drive. Read the manual before working on the drive. The reader is expected to know the fundamentals of electricity, wiring, electrical components and electrical schematic symbols.



# Installation

---

Study these installation instructions carefully before proceeding. **Failure to observe the warnings and instructions may cause a malfunction or personal hazard.**



**WARNING!** Before you begin read chapter [Safety instructions](#) on page 5.

**Note:** The installation must always be designed and made according to applicable local laws and regulations. ABB does not assume any liability whatsoever for any installation which breaches the local laws and/or other regulations. Furthermore, if the recommendations given by ABB are not followed, the drive may experience problems that the warranty does not cover.

## Installation flow chart

The installation of the ACS550 adjustable speed AC drive follows the outline below. The steps must be carried out in the order shown. At the right of each step are references to the detailed information needed for the correct installation of the drive.

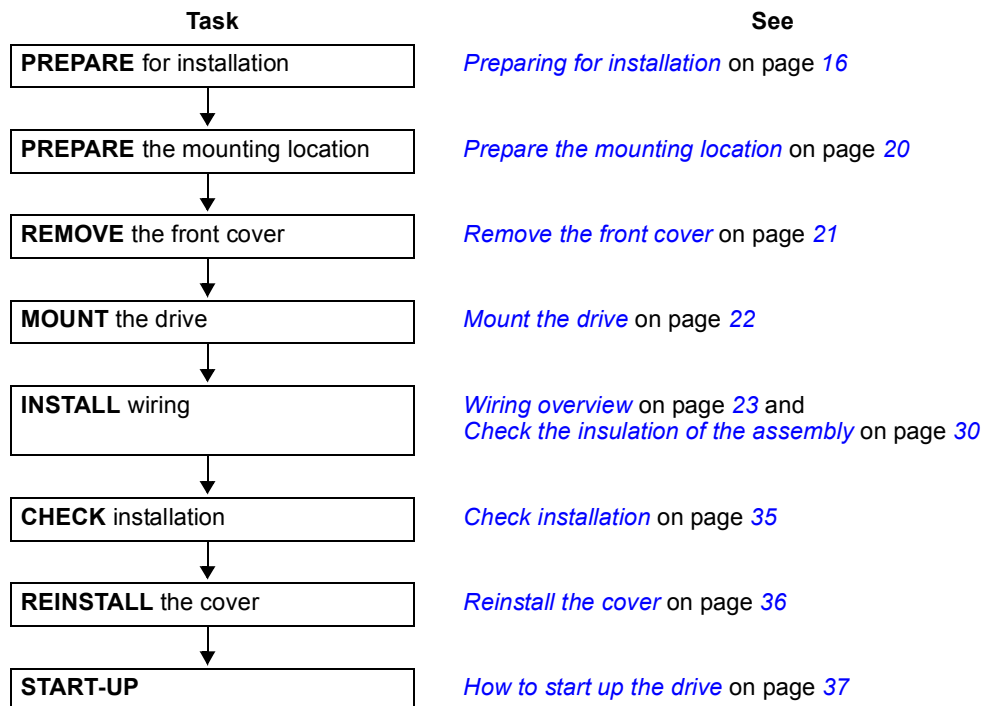

## Preparing for installation

### Lifting the drive

Lift the drive only by the metal chassis.

### Unpacking the drive

1. Unpack the drive.
2. Check for any damage and notify the shipper immediately if damaged components are found.
3. Check the contents against the order and the shipping label to verify that all parts have been received.



IP2040

### Drive identification

#### Drive labels

To determine the type of drive you are installing, refer to either:

- serial number label attached on upper part of the choke plate between the mounting holes, or



- type designation label attached on the heat sink – on the right side of the drive cover. Two examples of the type designation label are given below.

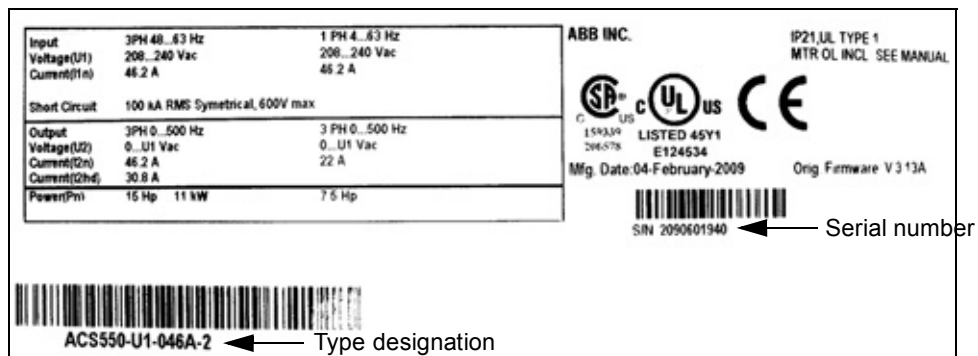
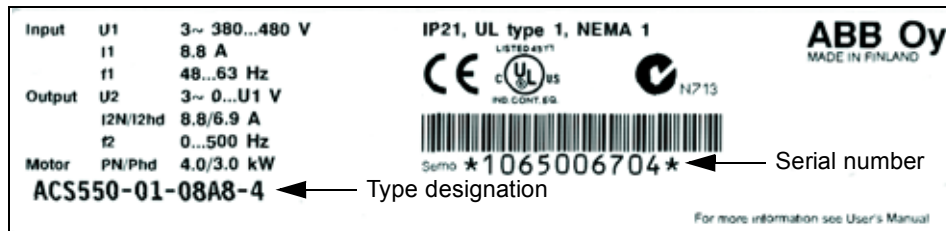



The labels contain information on the [Type designation](#) (page 17), [Ratings and frame size](#) (page 17), [Serial number](#) (page 17), degree of protection (see also [Degrees of protection](#) on page 306) and valid markings (see also [Markings](#) on page 309).

### Type designation

Use the following chart to interpret the type designation found on both the type designation and the serial number label.

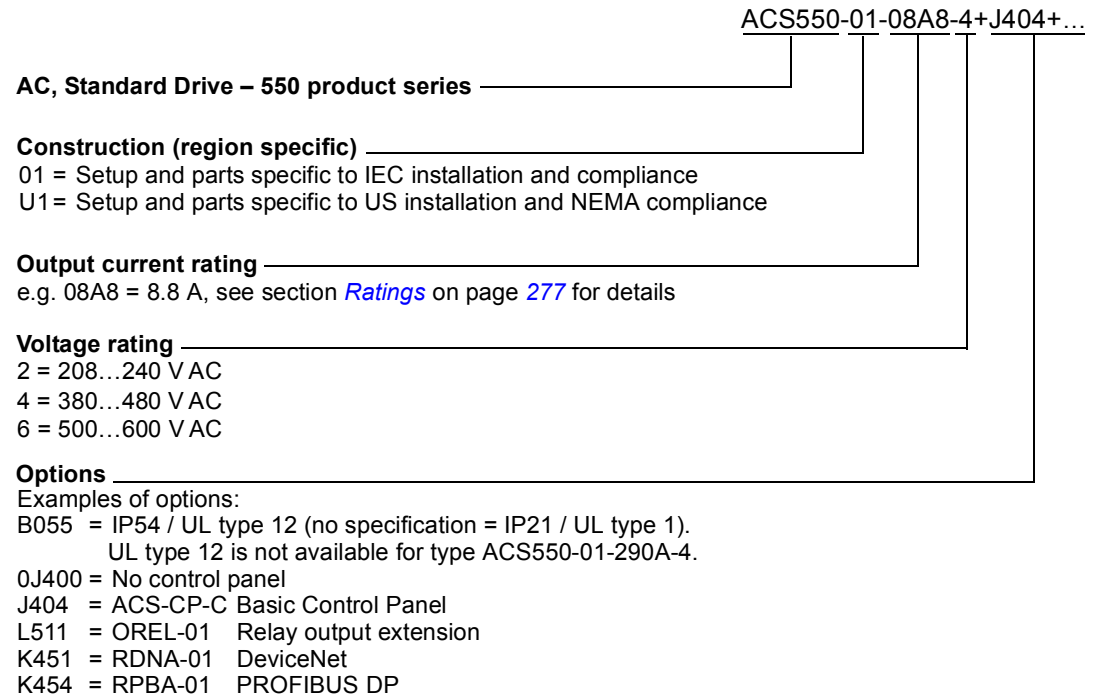

### Ratings and frame size

The chart in section [Ratings](#) on page 277 lists technical specifications and identifies the drive's frame size – significant, since some instructions in this document vary, depending on the drive's frame size. To read the ratings table, you need the “Output current rating” entry from the type designation. Also, when using the ratings table, note that the table is broken into sections based on the drive's “Voltage rating”.

### Serial number

The format of the drive serial number shown on the labels is described below.

Serial number is of format CYYWWXXXXX, where

C: Country of manufacture

YY: Year of manufacture

WW: Week of manufacture; 01, 02, 03, ... for week 1, week 2, week 3, ...

XXXXX: Integer starting every week from 00001.

## Motor compatibility

The motor, drive and supply power must be compatible:

Motor specification	Verify	Reference
Motor type	3-phase induction motor	–
Nominal current	Motor value is within this range: $0.2 \dots 2.0 \cdot I_{2hd}$ ( $I_{2hd}$ = drive heavy duty current)	<ul style="list-style-type: none"> <li>Type designation label on drive, entry for Output <math>I_{2hd}</math>, or</li> <li>Type designation on drive and rating table in chapter <a href="#">Technical data</a> on page 277.</li> </ul>
Nominal frequency	10...500 Hz	–
Voltage range	Motor is compatible with the ACS550 voltage range.	208...240 V (for ACS550-X1-XXXX-2) or 380...480 V (for ACS550-X1-XXXX-4) or 500...600 V (for ACS550-U1-XXXX-6)
Insulation	500...600 V drives: Either the motor complies with NEMA MG1 Part 31, or a du/dt filter is used between the motor and drive.	For ACS550-U1-XXXX-6

## Tools required

To install the ACS550 you need the following:

- screwdrivers (as appropriate for the mounting hardware used)
- wire stripper
- tape measure
- drill
- for installations involving ACS550-U1, frame sizes R5 or R6 and IP54 / UL type 12 enclosures: punch for creating conduit mounting holes
- for installations involving ACS550-U1, frame size R6: appropriate crimping tool for power cable lugs. See section [Power terminal considerations – R6 frame size](#) on page 287.
- mounting hardware: screws or nuts and bolts, four each. The type of hardware depends on the mounting surface and the frame size. For the dimensions and weights of the frames, see [Dimensions and weights](#) on page 303.

Frame size	Mounting hardware	
R1...R4	M5	#10
R5	M6	1/4 in
R6	M8	5/16 in

## Suitable environment and enclosure

Confirm that the site meets the environmental requirements. To prevent damage prior to installation, store and transport the drive according to the environmental requirements specified for storage and transportation. See section [Ambient conditions](#) on page 307.

Confirm that the enclosure is appropriate, based on the site contamination level:

- IP21 / UL type 1 enclosure: The site must be free of airborne dust, corrosive gases or liquids, and conductive contaminants such as dripping water, condensation, carbon dust and metallic particles.
- IP54 / UL type 12 enclosure: This enclosure provides protection from airborne dust and light sprays or splashing water from all directions.
- If, for some reason, an IP21 drive needs to be installed without the conduit box or cover, or an IP54 drive without the conduit plate or hood, see the note in chapter [Technical data](#), page 310.

### **Suitable mounting location**

Confirm that the mounting location meets the following constraints:

- The drive must be mounted vertically on a smooth, solid surface, and in a suitable environment as defined above. For horizontal installation, contact your local ABB representative for more information.
- The minimum space requirements for the drive are the outside dimensions (see section [Outside dimensions](#) on page 304), plus air flow space around the drive (see section [Losses, cooling data and noise](#) on page 301).
- The distance between the motor and the drive is limited by the maximum motor cable length. See section [Motor connection specifications](#) on page 289.
- The mounting site must support the drive's modest weight. See section [Weight](#) on page 306.

## Installing the drive



**WARNING!** Before installing the ACS550, ensure the input power supply to the drive is off.

For flange mounting (mounting the drive in a cooling air duct), see the appropriate *Flange Mounting Instructions*:

Frame size	IP21 / UL type 1		IP54 / UL type 12	
	Kit	Code (English)	Kit	Code (English)
R1	FMK-A-R1	100000982	FMK-B-R1	100000990
R2	FMK-A-R2	100000984	FMK-B-R2	100000992
R3	FMK-A-R3	100000986	FMK-B-R3	100000994
R4	FMK-A-R4	100000988	FMK-B-R4	100000996
R5	AC8-FLNGMT-R5 <sup>1</sup>	ACS800-PNTG01U-EN	-	-
R6	AC8-FLNGMT-R6 <sup>1</sup>		-	-

1. Not available in ACS550-01 series.

### Prepare the mounting location

The ACS550 should only be mounted where all of the requirements defined in section [Preparing for installation](#) on page 16 are met.

1. Mark the position of the mounting holes with the help of the mounting template provided with the drive.
2. Drill the holes.

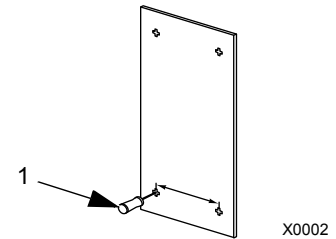

**Note:** Frame sizes R3 and R4 have four holes along the top. Use only two. If possible, use the two outside holes (to allow room to remove the fan for maintenance).

**Note:** ACS400 drives can be replaced using the original mounting holes. For R1 and R2 frame sizes, the mounting holes are identical. For R3 and R4 frame sizes, the inside mounting holes on the top of ACS550 drives match ACS400 mounts.

## Remove the front cover

### IP21 / UL type 1

1. Remove the control panel, if attached.
2. Loosen the captive screw at the top.
3. Pull near the top to remove the cover.

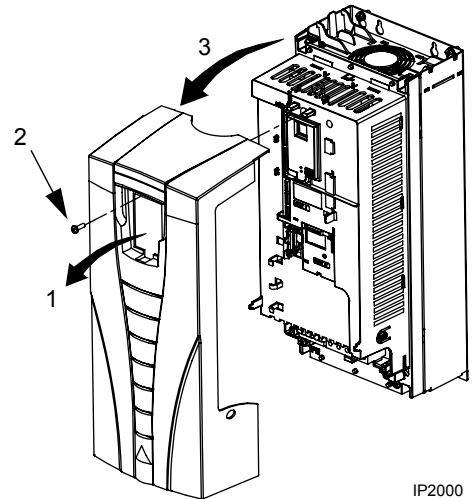

IP2000

### IP54 / UL type 12

1. If hood is present: Remove screws (2) holding hood in place.
2. If hood is present: Slide hood up and off of the cover.
3. Loosen the captive screws around the edge of the cover.
4. Remove the cover.

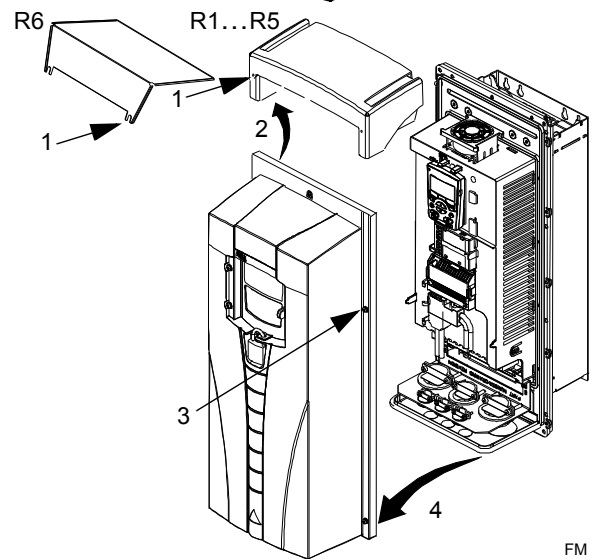

FM

## Mount the drive

### IP21 / UL type 1

1. Position the ACS550 onto the mounting screws or bolts and securely tighten in all four corners.

---

**Note:** Lift the ACS550 by its metal chassis (frame size R6) by the lifting holes on both sides at the top.

---

2. Non-English speaking locations: Add a warning sticker in the appropriate language over the existing warning on the top of the module.

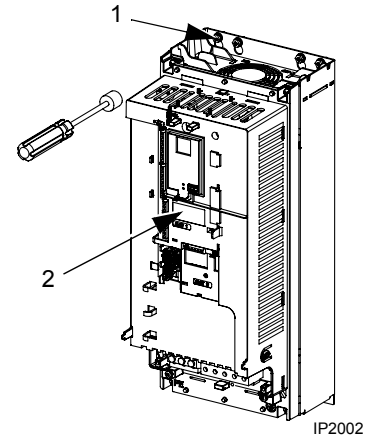

### IP54 / UL type 12

For the IP54 / UL type 12 enclosures, rubber plugs are required in the holes provided for access to the drive mounting slots.

1. As required for access, remove the rubber plugs. Push plugs out from the back of the drive.
2. R5 & R6: Align the sheet metal hood (not shown) in front of the drive's top mounting holes. (Attach as part of next step.)
3. Position the ACS550 onto the mounting screws or bolts and securely tighten in all four corners.

---

**Note:** Lift the ACS550 by its metal chassis (frame size R6) by the lifting holes on both sides at the top.

---

4. Reinstall the rubber plugs.
5. Non-English speaking locations: Add a warning sticker in the appropriate language over the existing warning on the top of the module.

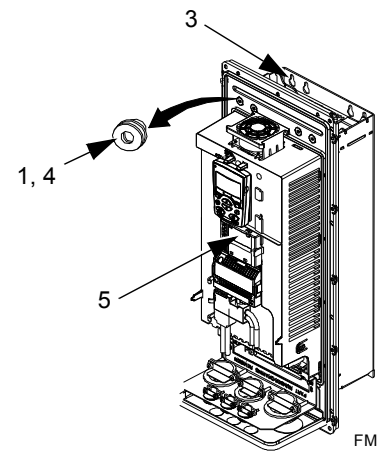

## Wiring overview

### Conduit/Gland kit

Wiring drives with the IP21 / UL type 1 enclosure requires a conduit/gland kit with the following items:

- conduit/gland box
- five (5) cable clamps (ACS550-01 only)
- screws
- cover.

The kit is included with IP21 / UL type 1 enclosures.

### Wiring requirements



**WARNING!** Ensure the motor is compatible for use with the ACS550. The drive must be installed by a competent person in accordance with the considerations defined in section [Preparing for installation](#) on page 16. If in doubt, contact your local ABB representative.

As you install the wiring, observe the following:

- There are four sets of wiring instructions – one set for each combination of drive enclosure type (IP21 / UL type and IP54 / UL type 12) and wiring type (conduit or cable). Be sure to select the appropriate procedure.
- Determine electro-magnetic compliance (EMC) requirements per local codes. See section [Motor cable requirements for CE & C-Tick compliance](#) on page 293. In general:
  - Follow local codes for cable size.
  - Keep these four classes of wiring separated: input power wiring, motor wiring, control/communications wiring and braking unit wiring.
- When installing input power and motor wiring, refer to the following, as appropriate:

Terminal	Description	Specifications and notes
U1, V1, W1 <sup>1</sup>	3-phase power supply input	<a href="#">Input power connections</a> on page 281
PE	Protective Ground	<a href="#">Ground connections</a> on page 285
U2, V2, W2	Power output to motor	<a href="#">Motor connections</a> on page 289

<sup>1</sup> The ACS550 -x1-xxxx-2 (208...240 V series) can be used with a single phase supply, if output current is derated by 50%. For single phase supply voltage, connect power at U1 and W1.

- To locate input power and motor connection terminals, see section [Power connection diagrams](#) on page 25. For specifications on power terminals, see section [Drive's power connection terminals](#) on page 286.
- For corner-grounded TN systems, see section [Corner-grounded TN systems](#) on page 285.
- For IT systems, see section [IT systems](#) on page 286.

- For frame size R6, see section [Power terminal considerations – R6 frame size](#) on page [287](#) to install the appropriate cable lugs.
- For drives using braking (optional), refer to the following, as appropriate:

Frame size	Terminal	Description	Braking accessory
R1, R2	BRK+, BRK-	Braking resistor	Braking resistor. See section <a href="#">Brake components</a> on page <a href="#">295</a> .
R3, R4, R5, R6	UDC+, UDC-	DC bus	Contact your ABB representative to order either: <ul style="list-style-type: none"> <li>• braking unit or</li> <li>• chopper and resistor</li> </ul>

- When installing control wiring, refer to the following chapters or sections, as appropriate:
  - [Control terminals table](#) on page [28](#)
  - [Control connections](#) on page [299](#)
  - [Application macros](#) on page [77](#)
  - [Complete parameter descriptions](#) on page [106](#)
  - [Embedded fieldbus](#) on page [203](#)
  - [Fieldbus adapter](#) on page [237](#).



Power connection diagrams

The following diagram shows the terminal layout for frame size R3, which, in general, applies to frame sizes R1...R6, except for the R5/R6 power and ground terminals.

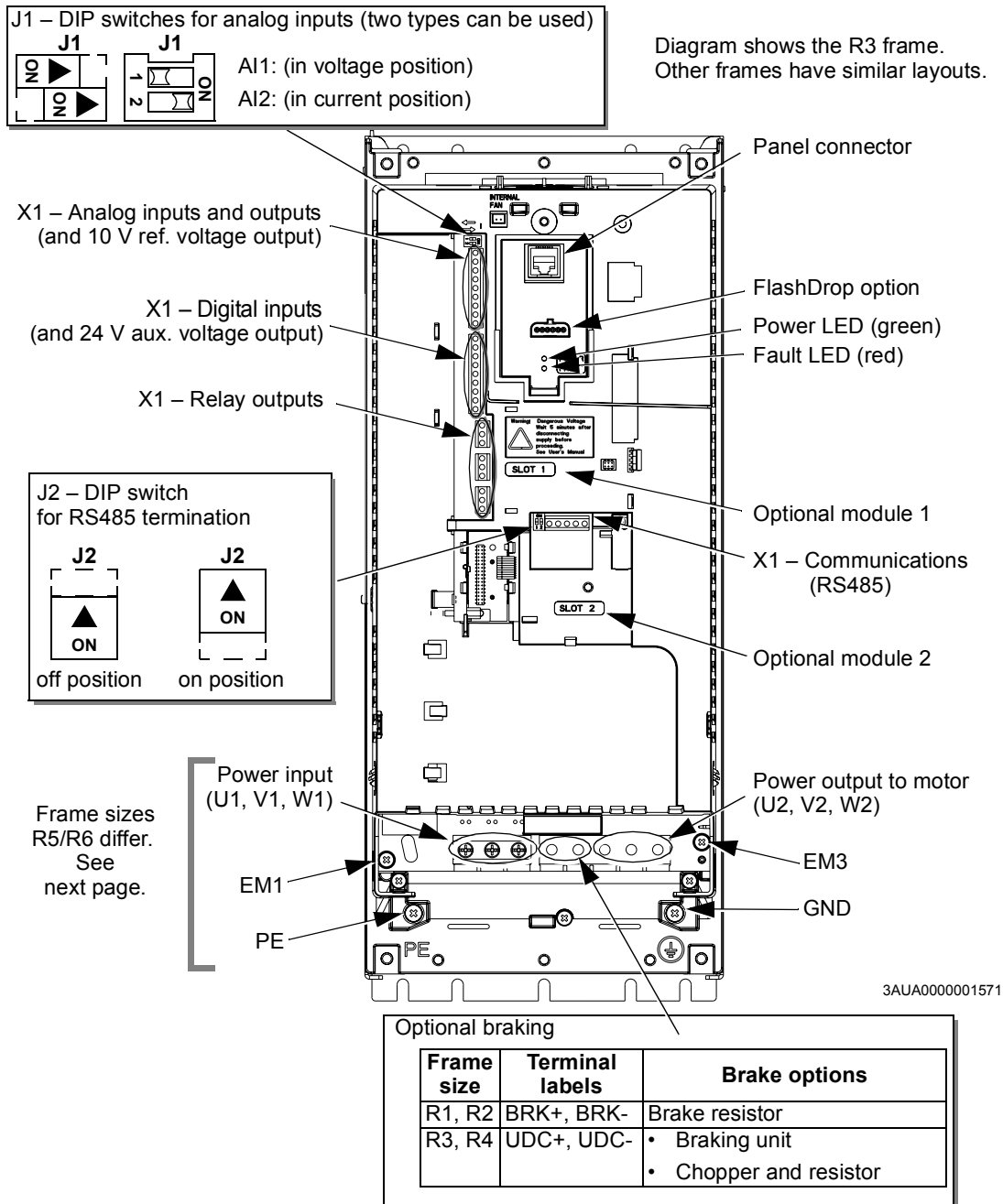

**WARNING!** To avoid danger, or damage to the drive, on IT systems and corner-grounded TN systems, see section [Disconnecting the internal EMC filter](#) on page 27.

The following diagram shows the power and ground terminal layout for frame sizes R5 and R6end

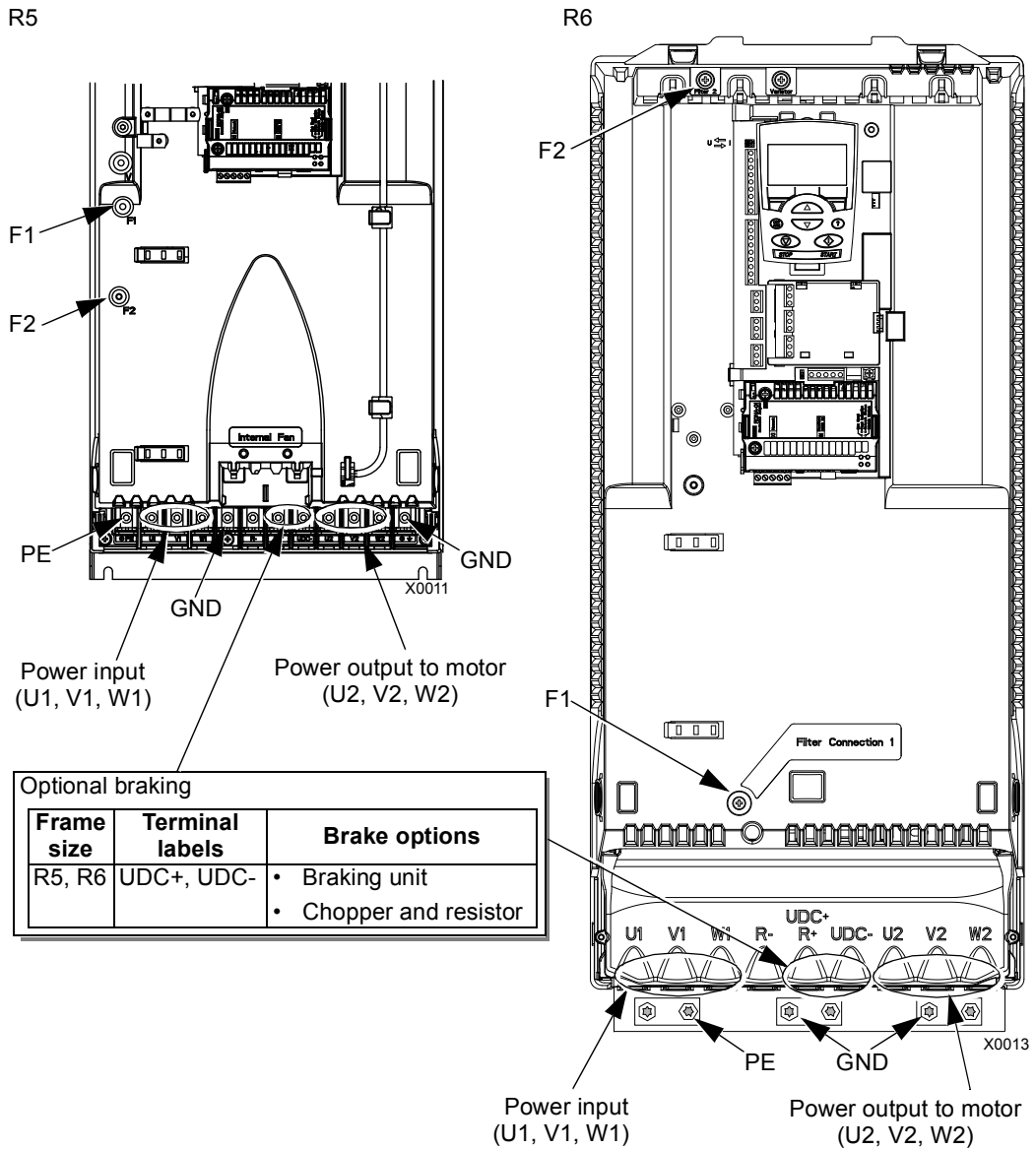

**WARNING!** To avoid danger, or damage to the drive, on IT systems and corner-grounded TN systems, see section *Disconnecting the internal EMC filter* on page 27.

### Disconnecting the internal EMC filter

On certain types of systems, you must disconnect the internal EMC filter, otherwise the system will be connected to ground potential through the EMC filter capacitors, which might cause danger, or damage the drive.

**Note:** Disconnecting the internal EMC filter increases the conducted emission and reduces the drive EMC compatibility considerably.

The following table shows the installation rules for the EMC filter screws in order to connect or disconnect the filter, depending on the system type and the frame size. For more information on the different system types, see [IT systems](#) on page 286 and [Corner-grounded TN systems](#) on page 285.

The locations of screws EM1 and EM3 are shown in the diagram on page 25. The locations of screws F1 and F2 are shown in the diagram on page 26.

Frame sizes	Screw	Symmetrically grounded TN systems (TN-S systems)	Corner-grounded TN systems	IT systems (ungrounded or high-resistance-grounded [ $> 30 \text{ ohm}$ ])
R1...R3	EM1	x	x	•
	EM3 <sup>1</sup>	x	•	•
R4	EM1	x	x	–
	EM3 <sup>1</sup>	x	–	–
R5...R6	F1	x	x	–
	F2	x	x	–

x = Install the screw. (EMC filter will be connected.)



• = Replace the screw with the provided polyamide screw. (EMC filter will be disconnected.)



– = Remove the screw. (EMC filter will be disconnected.)

<sup>1</sup> ACS550-U1 drives are shipped with screw EM3 already removed.

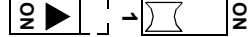
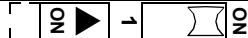
## Control terminals table

The following provides information for connecting control wiring at X1 on the drive.

	X1	Hardware description		
Analog I/O	1	SCR Terminal for signal cable shield (screen). (Connected internally to chassis ground.)		
	2	AI1 Analog input channel 1, programmable. Default <sup>2</sup> = frequency reference. Resolution 0.1%, accuracy ±1%.  Two different DIP switch types can be used. J1: AI1 OFF: 0...10 V ( $R_i = 312 \text{ kohm}$ )  NO J1: AI1 ON: 0...20 mA ( $R_i = 100 \text{ ohm}$ ) 		
			3	AGND Analog input circuit common (connected internally to chassis gnd. through 1 Mohm).
			4	+10 V Potentiometer reference source: 10 V ±2%, max. 10 mA ( $1 \text{ kohm} \leq R \leq 10 \text{ kohm}$ ).
			5	AI2 Analog input channel 2, programmable. Default <sup>2</sup> = not used. Resolution 0.1%, accuracy ±1%.  Two different DIP switch types can be used. J1: AI2 OFF: 0...10 V ( $R_i = 312 \text{ kohm}$ )  NO J1: AI2 ON: 0...20 mA ( $R_i = 100 \text{ ohm}$ ) 
	6	AGND Analog input circuit common (connected internally to chassis gnd. through 1 Mohm).		
	7	AO1 Analog output, programmable. Default <sup>2</sup> = frequency. 0...20 mA (load < 500 ohm). Accuracy ±3%.		
	8	AO2 Analog output, programmable. Default <sup>2</sup> = current. 0...20 mA (load < 500 ohm). Accuracy ±3%.		
	9	AGND Analog output circuit common (connected internally to chassis gnd. through 1 Mohm).		
	Digital inputs <sup>1</sup>	10	+24V Auxiliary voltage output 24 V DC / 250 mA (reference to GND), short circuit protected.	
11		GND Auxiliary voltage output common (connected internally as floating).		
12		DCOM Digital input common. To activate a digital input, there must be $\geq +10 \text{ V}$ (or $\leq -10 \text{ V}$ ) between that input and DCOM. The 24 V may be provided by the ACS550 (X1-10) or by an external 12...24 V source of either polarity.		
13		DI1 Digital input 1, programmable. Default <sup>2</sup> = start/stop.		
14		DI2 Digital input 2, programmable. Default <sup>2</sup> = fwd/rev.		
15		DI3 Digital input 3, programmable. Default <sup>2</sup> = constant speed sel (code).		
16		DI4 Digital input 4, programmable. Default <sup>2</sup> = constant speed sel (code).		
17		DI5 Digital input 5, programmable. Default <sup>2</sup> = ramp pair selection (code).		
18	DI6 Digital input 6, programmable. Default <sup>2</sup> = not used.			

		X1	Hardware description
Relay outputs	19	RO1C	 Relay output 1, programmable. Default <sup>2</sup> = Ready Maximum: 250 V AC / 30 V DC, 2 A Minimum: 500 mW (12 V, 10 mA)
	20	RO1A	
	21	RO1B	
	22	RO2C	 Relay output 2, programmable. Default <sup>2</sup> = Running Maximum: 250 V AC / 30 V DC, 2 A Minimum: 500 mW (12 V, 10 mA)
	23	RO2A	
	24	RO2B	
	25	RO3C	 Relay output 3, programmable. Default <sup>2</sup> = Fault (-1) Maximum: 250 V AC / 30 V DC, 2 A Minimum: 500 mW (12 V, 10 mA)
	26	RO3A	
	27	RO3B	

<sup>1</sup> Digital input impedance 1.5 kohm. Maximum voltage for digital inputs is 30 V.

<sup>2</sup> Default values depend on the macro used. Values specified are for the default macro. See chapter [Application macros](#) on page 77.

**Note:** Terminals 3, 6 and 9 are at the same potential.

**Note:** For safety reasons the fault relay signals a “fault” when the ACS550 is powered down.



**WARNING!** All ELV (Extra Low Voltage) circuits connected to the drive must be used within a zone of equipotential bonding, i.e. within a zone where all simultaneously accessible conductive parts are electrically connected to prevent hazardous voltages appearing between them. This is accomplished by a proper factory grounding.

The terminals on the control board as well as on the optional modules attachable to the board fulfil the Protective Extra Low Voltage (PELV) requirements stated in EN 50178, provided that the external circuits connected to the terminals also fulfil the requirements and the installation site is below 2000 m (6562 ft).

You can wire the digital input terminals in either a PNP or NPN configuration.

PNP connection (source)

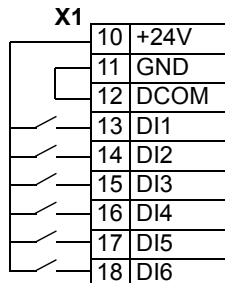

NPN connection (sink)

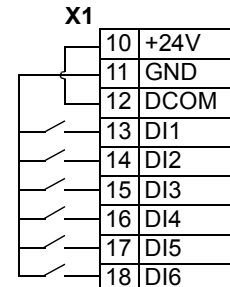

## Check the insulation of the assembly

### Drive

Do not make any voltage tolerance or insulation resistance tests on any part of the drive as testing can damage the drive. Every drive has been tested for insulation between the main circuit and the chassis at the factory. Also, there are voltage-limiting circuits inside the drive which cut down the testing voltage automatically.

### Supply cable

Check the insulation of the supply (input) cable according to local regulations before connecting to the drive.

### Motor and motor cable

Check the insulation of the motor and motor cable as follows:

1. Check that the motor cable is connected to the motor, and disconnected from the drive output terminals U2, V2 and W2.

2. Measure the insulation resistance between phase conductors and between each phase conductor and the Protective Earth conductor using a measuring voltage of 1000 V DC. The insulation resistance of an ABB motor must exceed 100 Mohm (reference value at 25 °C or 77 °F). For the insulation resistance of other motors, please consult the manufacturer's instructions. **Note:** Moisture inside the motor casing will reduce the insulation resistance. If moisture is suspected, dry the motor and repeat the measurement.

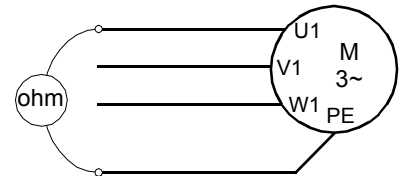

## Install the wiring

### Wiring IP21 / UL type 1 enclosure with cables

1. Open the appropriate knockouts in the conduit/gland box. (See section [Conduit/Gland kit](#) on page 23.)
2. Install the cable clamps for the power/motor cables.

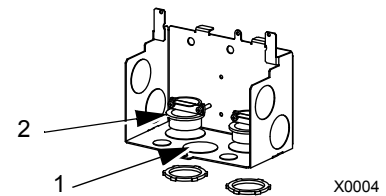

3. On the input power cable, strip the sheathing back far enough to route individual wires.
4. On the motor cable, strip the sheathing back far enough to expose the copper wire shield so that the shield can be twisted into a bundle (pig-tail). Keep the bundle not longer than five times its width to minimize noise radiation.  
360° grounding under the clamp is recommended for the motor cable to minimize noise radiation. In this case, remove the sheathing at the cable clamp.
5. Route both cables through the clamps.
6. Strip and connect the power/motor wires and the power ground wire to the drive terminals. See the table on the right for tightening torques.

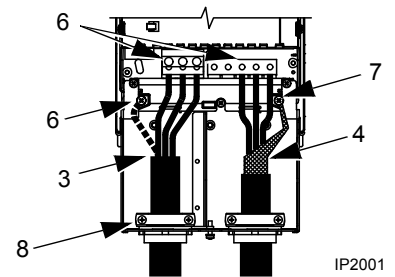

Frame size	Tightening torque	
	N·m	lb·ft
R1, R2	1.4	1
R3	2.5	1.8
R4	5.6; PE: 2	4; PE 1.5
R5	15	11
R6	40; PE: 8	30; PE: 6

**Note:** For R6 frame size, refer to section [Power terminal considerations – R6 frame size](#) on page 287.

7. Connect the bundle (pig-tail) created from the motor cable shield to the GND terminal.
8. Install conduit/gland box and tighten the cable clamps.
9. Install the cable clamp(s) for the control cable(s). (Power/motor cables and clamps not shown in the figure.)
10. Strip control cable sheathing and twist the copper shield into a bundle (pig-tail).
11. Route control cable(s) through clamp(s) and tighten clamp(s).
12. Connect the ground shield bundle (pig-tail) for digital and analog I/O cables at X1-1. (Ground only at the drive end.)
13. Strip and connect the individual control wires to the drive terminals. See section [Control terminals table](#) on page 28. Use a tightening torque of 0.4 N·m (0.3 lb·ft).
14. Install the conduit/gland box cover (1 screw).

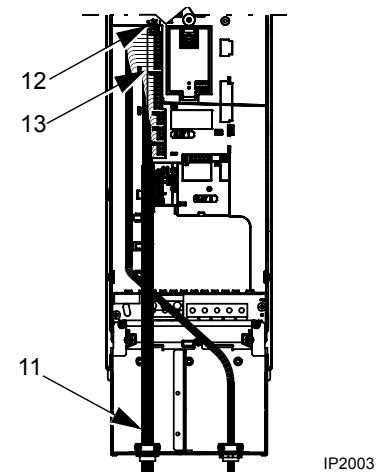
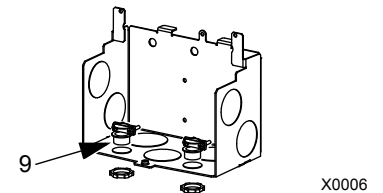
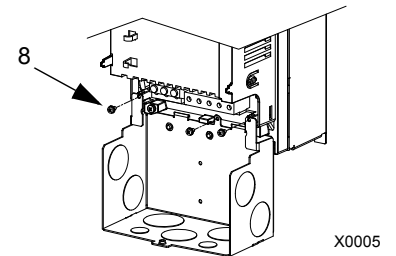

### Wiring IP21 / UL type 1 enclosure with **conduit**

1. Open the appropriate knockouts in the conduit/gland box. (See section [Conduit/Gland kit](#) on page 23.)
2. Install thin-wall conduit clamps (not supplied).
3. Install conduit/gland box.
4. Connect conduit runs to box.
5. Route input power and motor wiring through conduits (must be separate conduit runs).
6. Strip wires.
7. Connect power, motor and ground wires to the drive terminals. See the table on the right for tightening torques.

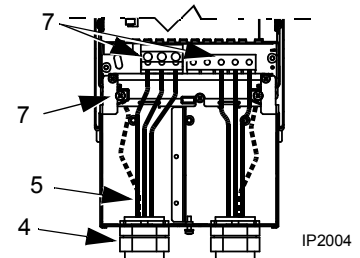
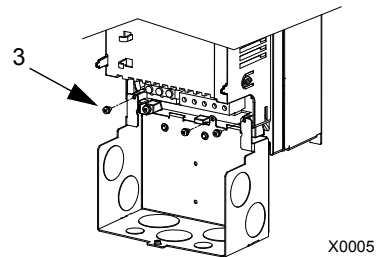
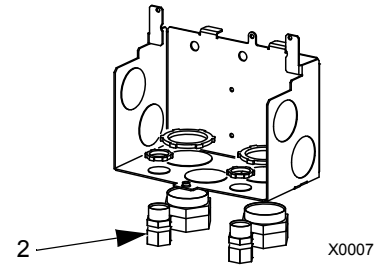

**Note:** For R6 frame size, refer to section [Power terminal considerations – R6 frame size](#) on page 287.

Frame size	Tightening torque	
	N·m	lb·ft
R1, R2	1.4	1
R3	2.5	1.8
R4	5.6; PE: 2	4; PE 1.5
R5	15	11
R6	40; PE: 8	30; PE: 6

8. Route the control cable through the conduit (must be separate from input power and motor conduit runs).
9. Strip the control cable sheathing and twist the copper shield into a bundle (pig-tail).
10. Connect the ground shield bundle (pig-tail) for digital and analog I/O cables at X1-1. (Ground only at the drive end.)
11. Strip and connect the individual control wires to the drive terminals. See section [Control terminals table](#) on page 28. Use a tightening torque of 0.4 N·m (0.3 lb·ft).
12. Install the conduit/gland box cover (1 screw).

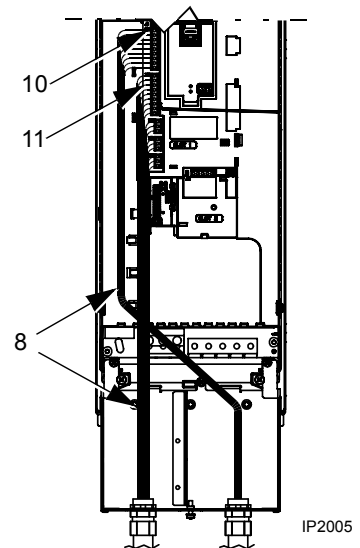



### Wiring **IP54** / UL type 12 enclosure with **cables**

1. Cut the cable seals as needed for the power, motor and control cables. The cable seals are cone-shaped, rubber seals on the bottom of the drive. The conical part of the seals must face downwards when the seals are inserted in the lead-through plate holes.
2. On the input power cable, strip the sheathing back far enough to route individual wires.
3. On the motor cable, strip the sheathing back far enough to expose the copper wire shield so that the shield can be twisted into a bundle (pig-tail). Keep the bundle not longer than five times its width to minimize noise radiation. 360° grounding under the clamp is recommended for the motor cable to minimize noise radiation. In this case, remove the sheathing at the cable clamp.
4. Route both cables through the clamps and tighten the clamps.
5. Strip and connect the power/motor wires and the power ground wire to the drive terminals. See the table on the right for tightening torques.

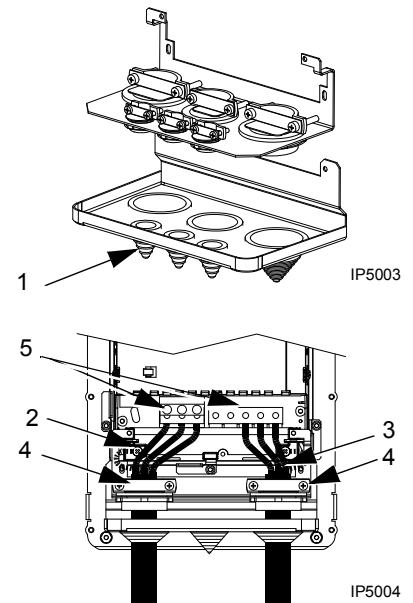

Frame size	Tightening torque	
	N·m	lb·ft
R1, R2	1.4	1
R3	2.5	1.8
R4	5.6; PE: 2	4; PE 1.5
R5	15	11
R6	40; PE: 8	30; PE: 6

**Note:** For R6 frame size, refer to section [Power terminal considerations – R6 frame size](#) on page 287.

6. Connect the bundle (pig-tail) created from the motor cable shield to the GND terminal.
7. Strip control cable sheathing and twist the copper shield into a bundle (pig-tail).
8. Route control cable(s) through clamp(s) and tighten clamp(s).
9. Connect the ground shield bundle (pig-tail) for digital and analog I/O cables at X1-1. (Ground only at the drive end.)
10. Strip and connect the individual control wires to the drive terminals. See section [Control terminals table](#) on page 28. Use a tightening torque of 0.4 N·m (0.3 lb·ft).

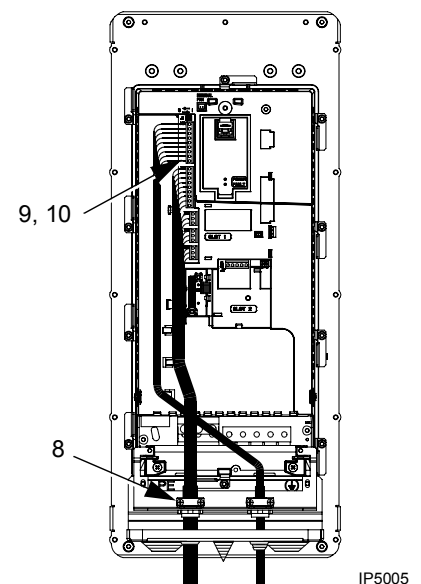

### Wiring IP54 / UL type 12 enclosure with **conduit**

1. Remove and discard the cable seals where conduit will be installed. (The cable seals are cone-shaped, rubber seals on the bottom of the drive.)
2. For each conduit run, install water tight conduit connectors (not supplied).
3. Route the power wiring through the conduit.
4. Route the motor wiring through the conduit.
5. Strip the wires.
6. Connect the power, motor and ground wires to the drive terminals. See the table on the right for tightening torques.

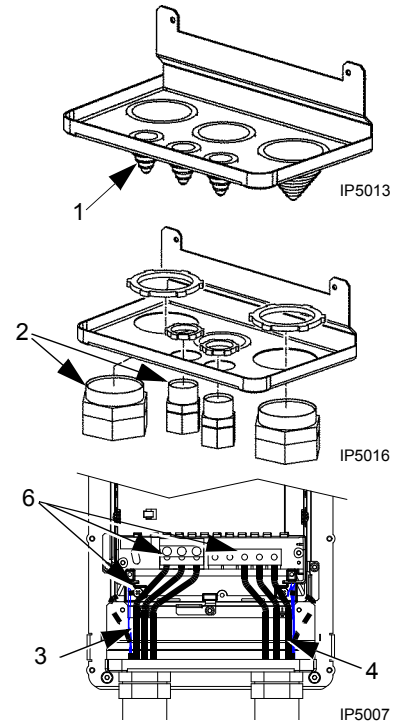

**Note:** For R6 frame size, refer to section [Power terminal considerations – R6 frame size](#) on page [287](#).

Frame size	Tightening torque	
	N·m	lb·ft
R1, R2	1.4	1
R3	2.5	1.8
R4	5.6; PE: 2	4; PE 1.5
R5	15	11
R6	40; PE: 8	30; PE: 6

7. Route the control cable through the conduit.
8. Strip the control cable sheathing and twist the copper shield into a bundle (pig-tail).
9. Connect the ground shield bundle (pig-tail) for digital and analog I/O cables at X1-1. (Ground only at the drive end.)
10. Strip and connect the individual control wires to the drive terminals. See section [Control terminals table](#) on page [28](#). Use a tightening torque of 0.4 N·m (0.3 lb·ft).

## Check installation

Before applying power, perform the following checks.

✓	Check
	Installation environment conforms to the drive's specifications for ambient conditions.
	The drive is mounted securely.
	Space around the drive meets the drive's specifications for cooling.
	The motor and driven equipment are ready for start.
	For IT systems and corner-grounded TN systems: The internal EMC filter is disconnected (see section <a href="#">Disconnecting the internal EMC filter</a> on page 27).
	The drive is properly grounded.
	The input power (mains) voltage matches the drive nominal input voltage.
	The input power (mains) connections at U1, V1 and W1 are connected and tightened as specified.
	The input power (mains) fuses are installed.
	The motor connections at U2, V2 and W2 are connected and tightened as specified.
	The motor cable is routed away from other cables.
	NO power factor compensation capacitors are in the motor cable.
	The control connections are connected and tightened as specified.
	NO tools or foreign objects (such as drill shavings) are inside the drive.
	NO alternate power source for the motor (such as a bypass connection) is connected – no voltage is applied to the output of the drive.

## Reinstall the cover

### IP21 / UL type 1

1. Align the cover and slide it on.
2. Tighten the captive screw.
3. Reinstall the control panel.
4. Continue with start-up. See chapter [Start-up, control with I/O and ID Run](#) on page 37.

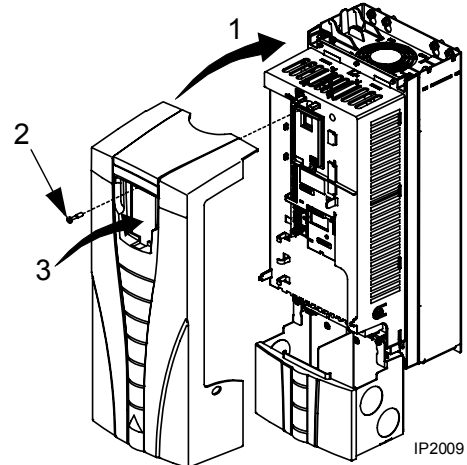

### IP54 / UL type 12

1. Align the cover and slide it on.
2. Tighten the captive screws around the edge of the cover.
3. Slide the hood down over the top of the cover. (Only needed for UL type 12 installations.)
4. Install the two screws that attach the hood. (Only needed for UL type 12 installations.)
5. Install the control panel.

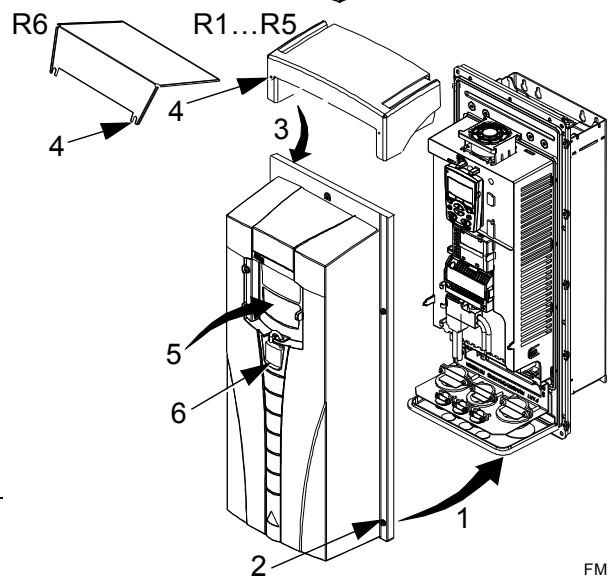

---

**Note:** The control panel window must be closed to comply with IP54 / UL type 12.

---

6. Optional: Add a lock (not supplied) to secure the control panel window.
7. Continue with start-up. See chapter [Start-up, control with I/O and ID Run](#) on page 37.

# Start-up, control with I/O and ID Run

---

The chapter instructs how to:

- perform the start-up
- start, stop, change the direction of rotation and adjust the speed of the motor through the I/O interface
- perform an Identification Run for the drive.

Using the control panel to do these tasks is explained briefly in this chapter. For details on how to use the control panel, refer to chapter [Control panels](#) starting on page [47](#).

## How to start up the drive

How you start up the drive depends on the control panel you have.

- **If you have an Assistant Control Panel**, you can either run the Start-up Assistant (see section [How to perform the guided start-up](#) on page [42](#)) or perform a limited start-up (see section [How to perform the limited start-up](#) on page [37](#)).

The Start-up Assistant, which is included in the Assistant Control Panel only, guides you through all essential settings to be done. In the limited start-up, the drive gives no guidance; you go through the very basic settings by following the instructions given in the manual.

- **If you have a Basic Control Panel**, follow the instructions given in section [How to perform the limited start-up](#) on page [37](#).

### How to perform the limited start-up

For the limited start-up, you can use the Basic Control Panel or the Assistant Control Panel. The instructions below are valid for both control panels, but the displays shown are the Basic Control Panel displays, unless the instruction applies to the Assistant Control Panel only.

Before you start, ensure that you have the motor nameplate data on hand.

#### SAFETY



The start-up may only be carried out by a qualified electrician.

The safety instructions given in chapter [Safety instructions](#) must be followed during the start-up procedure.



The drive will start up automatically at power up, if the external run command is on.

- Check the installation. See the checklist in chapter [Installation](#), page [35](#).

- Check that the starting of the motor does not cause any danger. **De-couple the driven machine** if:
  - there is a risk of damage in case of incorrect direction of rotation, or
  - an ID Run needs to be performed during the drive start-up. ID Run is essential only in applications that require the ultimate in motor control accuracy.

**POWER-UP**

- Apply input power.  
The Basic Control Panel powers up into the Output mode.

The Assistant Control Panel asks if you want to run the Start-up Assistant. If you press , the Start-up Assistant is not run, and you can continue with manual start-up in a similar manner as described below for the Basic Control Panel.















REM	<b>0.0</b>	Hz
OUTPUT		FWD
REM  CHOICE Do you want to use the start-up assistant? Yes No EXIT 00:00 OK		

**MANUAL ENTRY OF START-UP DATA (Group 99: START-UP DATA)**

- If you have an Assistant Control Panel, select the language (the Basic Control Panel does not support languages). See parameter [9901](#) for the values of the available language alternatives. You find parameter descriptions in section [Complete parameter descriptions](#) starting on page 106.

The general parameter setting procedure is described below for the Basic Control Panel. You find more detailed instructions for the Basic Control Panel on page 73. Instructions for the Assistant Control Panel are on page 55.

The general parameter setting procedure:

1. To go to the Main menu, press  if the bottom line shows OUTPUT; otherwise press  repeatedly until you see MENU at the bottom.
2. Press keys / until you see "PAR" and press .
3. Find the appropriate parameter group with keys / and press .
4. Find the appropriate parameter in the group with keys /.
5. Press and hold  for about two seconds until the parameter value is shown with **SET** under the value.
6. Change the value with keys /. The value changes faster while you keep the key pressed down.
7. Save the parameter value by pressing .

REM  PAR EDIT
9901 LANGUAGE <b>ENGLISH</b>
[0]
CANCEL 00:00 SAVE

REM	<b>rEF</b>	FWD
MENU		

REM	<b>-01-</b>	FWD
PAR		

REM	<b>2001</b>	FWD
PAR		

REM	<b>2002</b>	FWD
PAR		

REM	<b>1500</b>	rpm
PAR <b>SET</b> FWD		

REM	<b>1600</b>	rpm
PAR <b>SET</b> FWD		

REM	<b>2002</b>	FWD
PAR		

- Select the application macro (parameter 9902). The general parameter setting procedure is given above.  
The default value 1 (ABB STANDARD) is suitable in most cases.
- Select the motor control mode (parameter 9904).  
1 (VECTOR:SPEED) is suitable in most cases. 2 (VECTOR:TORQ) is suitable for torque control applications. 3 (SCALAR:FREQ) is recommended
  - for multimotor drives when the number of the motors connected to the drive is variable
  - when the nominal current of the motor is less than 20% of the nominal current of the drive
  - when the drive is used for test purposes with no motor connected.
- Enter the motor data from the motor nameplate:

ABB Motors CE									
3 ~ motor		M2AA 200 MLA 4							
IEC 200 M/L 55									
No									
					Ins.cl.	F	IP 55		
V	Hz	kW	r/min	A	cos φ	I <sub>A</sub> /I <sub>N</sub>	t <sub>E</sub> /s		
690 Y	50	30	1475	32.5	0.83				
400 D	50	30	1475	56	0.83				
660 Y	50	30	1470	34	0.83				
380 D	50	30	1470	59	0.83				
415 D	50	30	1475	54	0.83				
440 D	60	35	1770	59	0.83				
Cat. no 3GAA 202 001 - ADA									
6312/C3		6210/C3		180 kg					
IEC 34-1									

380 V  
supply  
voltage

- motor nominal voltage (parameter 9905)
- motor nominal current (parameter 9906)  
Allowed range: 0.2...2.0 · I<sub>2hd</sub> A
- motor nominal frequency (parameter 9907)
- motor nominal speed (parameter 9908)
- motor nominal power (parameter 9909)

REM 9902  
PAR FWD

REM 9904  
PAR FWD

**Note:** Set the motor data to exactly the same value as on the motor nameplate. For example, if the motor nominal speed is 1470 rpm on the nameplate, setting the value of parameter 9908 MOTOR NOM SPEED to 1500 rpm results in the wrong operation of the drive.

REM 9905  
PAR FWD

REM 9906  
PAR FWD

REM 9907  
PAR FWD

REM 9908  
PAR FWD

REM 9909  
PAR FWD

- Select the motor identification method (parameter [9910](#)).
- The default value 0 (OFF/IDMAGN) using the identification magnetization is suitable for most applications. It is applied in this basic start-up procedure. Note however that this requires that:
- parameter [9904](#) is set to 1 (VECTOR:SPEED) or 2 (VECTOR:TORQ), or
  - parameter [9904](#) is set to 3 (SCALAR:FREQ) and parameter [2101](#) is set to 3 (SCALAR FLYST) or 5 (FLY + BOOST).

If your selection is 0 (OFF/IDMAGN), move to the next step.

Value 1 (ON), which performs a separate ID Run, should be selected if:

- vector control mode is used [parameter [9904](#) = 1 (VECTOR:SPEED) or 2 (VECTOR:TORQ)], and/or
- the operation point is near zero speed, and/or
- operation at torque range above the motor nominal torque over a wide speed range and without any measured speed feedback is required.

If you decide to do the ID Run [value 1 (ON)], continue by following the separate instructions given on page [45](#) in section [How to perform the ID Run](#) and then return to step [DIRECTION OF THE MOTOR ROTATION](#) on page [40](#).









#### IDENTIFICATION MAGNETIZATION WITH ID RUN SELECTION 0 (OFF/IDMAGN)

- As stated above, the identification magnetization is performed only if:
- parameter [9904](#) is set to 1 (VECTOR:SPEED) or 2 (VECTOR:TORQ), or
  - parameter [9904](#) is set to 3 (SCALAR:FREQ) and parameter [2101](#) is set to 3 (SCALAR FLYST) or 5 (FLY + BOOST).

Press key  to switch to local control (LOC shown on the left).

Press  to start the drive. The motor model is now calculated by magnetizing the motor for 10 to 15 s at zero speed (motor not rotating).

#### DIRECTION OF THE MOTOR ROTATION

- Check the direction of the motor rotation.
- If the drive is in remote control (REM shown on the left), switch to local control by pressing .
  - To go to the Main menu, press  if the bottom line shows OUTPUT; otherwise press  repeatedly until you see MENU at the bottom.
  - Press keys / until you see “rEF” and press .
  - Increase the frequency reference from zero to a small value with key .
  - Press  to start the motor.
  - Check that the actual direction of the motor is the same as indicated on the display (FWD means forward and REV reverse).
  - Press  to stop the motor.

LOC	<b>XXX</b> Hz
	<b>SET</b> FWD



To change the direction of the motor rotation:

- Disconnect input power from the drive, and wait 5 minutes for the intermediate circuit capacitors to discharge. Measure the voltage between each input terminal (U1, V1 and W1) and earth with a multimeter to ensure that the drive is discharged.
- Exchange the position of two motor cable phase conductors at the drive output terminals or at the motor connection box.
- Verify your work by applying input power and repeating the check as described above.

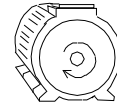

forward direction

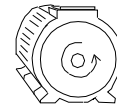

reverse direction

**SPEED LIMITS AND ACCELERATION/DECELERATION TIMES**

- Set the minimum speed (parameter [2001](#)).

LOC	<b>2001</b>
	PAR      FWD

- Set the maximum speed (parameter [2002](#)).

LOC	<b>2002</b>
	PAR      FWD

- Set the acceleration time 1 (parameter [2202](#)).  
**Note:** Check also acceleration time 2 (parameter [2205](#)) if two acceleration times will be used in the application.

LOC	<b>2202</b>
	PAR      FWD

- Set the deceleration time 1 (parameter [2203](#)).  
**Note:** Set also deceleration time 2 (parameter [2206](#)) if two deceleration times will be used in the application.

LOC	<b>2203</b>
	PAR      FWD

**SAVING A USER PARAMETER SET AND FINAL CHECK**

- The start-up is now completed. However, it might be useful at this stage to set the parameters required by your application and save the settings as a user parameter set as instructed in section [User parameter sets](#) on page [88](#).















LOC	<b>9902</b>
	PAR      FWD





- Check that the drive state is OK.  
Basic Control Panel: Check that there are no faults or alarms shown on the display. If you want to check the LEDs on the front of the drive, switch first to remote control (otherwise a fault is generated) before removing the panel and verifying that the red LED is not lit and the green LED is lit but not blinking.  
Assistant Control Panel: Check that there are no faults or alarms shown on the display and that the panel LED is green and does not blink.

**The drive is now ready for use.**

### How to perform the guided start-up

To be able to perform the guided start-up, you need the Assistant Control Panel. Before you start, ensure that you have the motor nameplate data on hand.

SAFETY	
	<p>The start-up may only be carried out by a qualified electrician.</p> <p>The safety instructions given in chapter <a href="#">Safety instructions</a> must be followed during the start-up procedure.</p>
	<p>The drive will start up automatically at power up, if the external run command is on.</p>
<ul style="list-style-type: none"> <li><input type="checkbox"/> Check the installation. See the checklist in chapter <a href="#">Installation</a>, page <a href="#">35</a>.</li> <li><input type="checkbox"/> Check that the starting of the motor does not cause any danger.                             <p><b>De-couple the driven machine if:</b></p> <ul style="list-style-type: none"> <li>• there is a risk of damage in case of incorrect direction of rotation, or</li> <li>• an ID Run needs to be performed during the drive start-up. ID Run is essential only in applications that require the ultimate in motor control accuracy.</li> </ul> </li> </ul>	
POWER-UP	
<ul style="list-style-type: none"> <li><input type="checkbox"/> Apply input power. The control panel first asks if you want to use the Start-up Assistant.                             <ul style="list-style-type: none"> <li>• Press  (when <b>Yes</b> is highlighted) to run the Start-up Assistant.</li> <li>• Press  if you do not want to run the Start-up Assistant.</li> <li>• Press key  to highlight <b>No</b> and then press  if you want to make the panel ask (or not ask) the question about running the Start-up Assistant again the next time you switch on the power to the drive.</li> </ul> </li> </ul>	<div style="border: 1px solid black; padding: 5px; margin-bottom: 10px;"> <p>REM ↻ CHOICE</p> <p>Do you want to use the start-up assistant?</p> <p><b>Yes</b></p> <p>NO</p> <p>EXIT   00:00   OK</p> </div> <div style="border: 1px solid black; padding: 5px;"> <p>REM ↻ CHOICE</p> <p>Show start-up assistant on next boot?</p> <p><b>Yes</b></p> <p>NO</p> <p>EXIT   00:00   OK</p> </div>
SELECTING THE LANGUAGE	
<ul style="list-style-type: none"> <li><input type="checkbox"/> If you decided to run the Start-up Assistant, the display then asks you to select the language. Scroll to the desired language with keys / and press  to accept. If you press , the Start-up Assistant is stopped.</li> </ul>	<div style="border: 1px solid black; padding: 5px;"> <p>REM ↻ PAR EDIT</p> <p>9901 LANGUAGE</p> <p style="text-align: center;"><b>ENGLISH</b></p> <p>[0]</p> <p>EXIT   00:00   SAVE</p> </div>
STARTING THE GUIDED SET-UP	
<ul style="list-style-type: none"> <li><input type="checkbox"/> The Start-up Assistant now guides you through the set-up tasks, starting with the motor set-up. Set the motor data to exactly the same value as on the motor nameplate. Scroll to the desired parameter value with keys / and press  to accept and continue with the Start-up Assistant.                             <p><b>Note:</b> At any time, if you press , the Start-up Assistant is stopped and the display goes to the Output mode.</p> </li> </ul>	<div style="border: 1px solid black; padding: 5px;"> <p>REM ↻ PAR EDIT</p> <p>9905 MOTOR NOM VOLT</p> <p style="text-align: center;"><b>220 V</b></p> <p>EXIT   00:00   SAVE</p> </div>

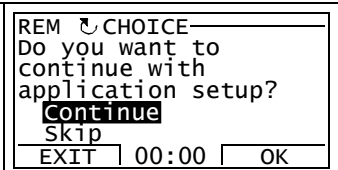
<input type="checkbox"/>	<p>After completing a set-up task, the Start-up Assistant suggests the next one.</p> <ul style="list-style-type: none"><li>• Press  (when <b>continue</b> is highlighted) to continue with the suggested task.</li><li>• Press key  to highlight <b>Skip</b> and then press  to move to the following task without doing the suggested task.</li><li>• Press  to stop the Start-up Assistant.</li></ul>	
<b>SAVING A USER PARAMETER SET AND FINAL CHECK</b>		
<input type="checkbox"/>	<p>The start-up is now completed. However, it might be useful at this stage to set the parameters required by your application and save the settings as a user parameter set as instructed in section <a href="#">User parameter sets</a> on page 88.</p>	
<input type="checkbox"/>	<p>After the whole set-up is completed, check there are no faults or alarms shown on the display and the panel LED is green and does not blink.</p>	
<b>The drive is now ready for use.</b>		

## How to control the drive through the I/O interface

The table below instructs how to operate the drive through the digital and analog inputs when:

- the motor start-up is performed, and
- the default (standard) parameter settings are valid.

Displays of the Basic Control Panel are shown as an example.

PRELIMINARY SETTINGS	
<p>If you need to change the direction of rotation, check that parameter <a href="#">1003</a> is set to 3 (REQUEST).</p> <p>Ensure that the control connections are wired according to the connection diagram given for the ABB Standard macro.</p> <p>Ensure that the drive is in remote control. Press key  to switch between remote and local control.</p>	<p>See section <a href="#">ABB Standard macro</a> on page 78.</p> <p>In remote control, the panel display shows text REM.</p>
STARTING AND CONTROLLING THE SPEED OF THE MOTOR	
<p>Start by switching digital input DI1 on.</p> <p>Assistant Control Panel: The arrow starts rotating. It is dotted until the setpoint is reached.</p> <p>Basic Control Panel: Text FWD starts flashing fast and stops after the setpoint is reached</p> <p>Regulate the drive output frequency (motor speed) by adjusting the voltage of analog input AI1.</p>	<div style="border: 1px solid black; padding: 5px; margin-bottom: 10px;"> <p>REM <span style="font-size: 2em; font-weight: bold;">0.0</span> HZ</p> <p>OUTPUT <span style="float: right;">FWD</span></p> </div> <div style="border: 1px solid black; padding: 5px;"> <p>REM <span style="font-size: 2em; font-weight: bold;">50.0</span> HZ</p> <p>OUTPUT <span style="float: right;">FWD</span></p> </div>
CHANGING THE DIRECTION OF ROTATION OF THE MOTOR	
<p>Reverse direction: Switch digital input DI2 on.</p> <p>Forward direction: Switch digital input DI2 off.</p>	<div style="border: 1px solid black; padding: 5px; margin-bottom: 10px;"> <p>REM <span style="font-size: 2em; font-weight: bold;">50.0</span> HZ</p> <p>OUTPUT <span style="float: right;">REV</span></p> </div> <div style="border: 1px solid black; padding: 5px;"> <p>REM <span style="font-size: 2em; font-weight: bold;">50.0</span> HZ</p> <p>OUTPUT <span style="float: right;">FWD</span></p> </div>
STOPPING THE MOTOR	
<p>Switch digital input DI1 off. The motor stops.</p> <p>Assistant Control Panel: The arrow stops rotating.</p> <p>Basic Control Panel: Text FWD starts flashing slowly.</p>	<div style="border: 1px solid black; padding: 5px;"> <p>REM <span style="font-size: 2em; font-weight: bold;">0.0</span> HZ</p> <p>OUTPUT <span style="float: right;">FWD</span></p> </div>

## How to perform the ID Run

The drive estimates motor characteristics automatically using identification magnetization when the drive is started for the first time and after any motor parameter (*Group 99: START-UP DATA*) is changed. This is valid when parameter **9910** ID RUN has value 0 (OFF/IDMAGN), and

- parameter **9904** = 1 (VECTOR:SPEED) or 2 (VECTOR:TORQ), or
- parameter **9904** = 3 (SCALAR:FREQ) and parameter **2101** = 3 (SCALAR FLYST) or 5 (FLY + BOOST).

In most applications there is no need to perform a separate ID Run [**9910** ID RUN = 1 (ON)]. The ID Run should be selected if:

- vector control mode is used [parameter **9904** = 1 (VECTOR:SPEED) or 2 (VECTOR:TORQ)], and/or
- the operation point is near zero speed, and/or
- operation at torque range above the motor nominal torque over a wide speed range and without any measured speed feedback is required.

**Note:** If motor parameters (*Group 99: START-UP DATA*) are changed after the ID Run, it must be repeated.

### ID Run procedure

The general parameter setting procedure is not repeated here. For Assistant Control Panel see page [55](#) and for Basic Control Panel page [73](#) in chapter *Control panels*.



#### PRE-CHECK



**WARNING!** The motor will run at up to approximately 50...80% of the nominal speed during the ID Run. The motor will rotate in the forward direction. **Ensure that it is safe to run the motor before performing the ID Run!**

- De-couple the motor from the driven equipment.
- Check that the values of the motor data parameters **9905...9909** are equivalent to those on the motor nameplate, as shown in the steps on page [39](#).
- If parameter values (*Group 01: OPERATING DATA* to *Group 98: OPTIONS*) are changed before the ID Run, check that the new settings meet the following conditions:
  - 2001** MINIMUM SPEED  $\leq 0$  rpm
  - 2002** MAXIMUM SPEED  $> 80\%$  of the motor rated speed
  - 2003** MAXIMUM CURRENT  $\geq I_{2hd}$
  - 2017** MAX TORQUE 1  $> 50\%$  or **2018** MAX TORQUE 2  $> 50\%$ , depending on which limit is in use according to parameter **2014** MAX TORQUE SEL.
- Check that the Run Enable signal is on (parameter **1601**).
- Ensure that the panel is in local control (LOC shown on the left / at the top). Press key  to switch between local and remote control.

**ID RUN WITH THE ASSISTANT CONTROL PANEL**

- Change parameter **9910** ID RUN to 1 (ON). Save the new setting by pressing .
  
- If you want to monitor actual values during the ID Run, go to the Output mode by pressing  repeatedly until you get there.
  
- Press  to start the ID Run. The panel keeps switching between the display that was shown when you started the ID Run and the alarm display presented on the right.
 



In general, it is recommended not to press any control panel keys during the ID Run. However, you can stop the ID Run at any time by pressing .

After the ID Run is completed, the alarm display is not shown any more.

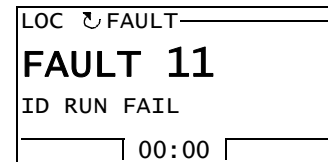
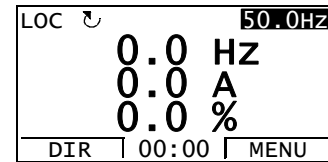
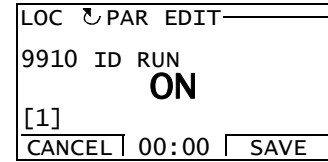
If the ID Run fails, the fault display presented on the right is shown.



**ID RUN WITH THE BASIC CONTROL PANEL**

- Change parameter **9910** ID RUN to 1 (ON). Save the new setting by pressing .
  
- If you want to monitor actual values during the ID Run, go to the Output mode by pressing  repeatedly until you get there.
  
- Press  to start the ID Run. The panel keeps switching between the display that was shown when you started the ID Run and the alarm display presented on the right.
 

In general, it is recommended not to press any control panel keys during the ID Run. However, you can stop the ID Run at any time by pressing .

After the ID Run is completed, the alarm display is not shown any more.

If the ID Run fails, the fault display presented on the right is shown.

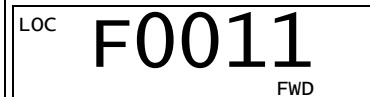

# Control panels

---

## About control panels

Use a control panel to control the drive, read status data and adjust parameters. The drive works with either of two different control panel types:

- Basic Control Panel – This panel (described in section [Basic Control Panel](#) on page 68) provides basic tools for manual entry of parameter values.
- Assistant Control Panel – This panel (described below) includes pre-programmed assistants to automate the most common parameter setups. The panel provides language support. It is available with different language sets.

## Compatibility

The manual is compatible with the following panel versions:

- Basic Control Panel: ACS-CP-C Rev. M or later
- Assistant Control Panel (Area 1): ACS-CP-A Rev. F or later (new panel series manufactured since 2007 with serial number XYYWWRXXXX, where year YY = 07 or greater and revision R = F, G, E, ...)
- Assistant Control Panel (Asia): ACS-CP-D Rev. Q or later

See page 51 for how to find out the version of your Assistant Control Panel. See parameter 9901 LANGUAGE to see the languages supported by the different Assistant Control Panels.

## Assistant Control Panel

### Features

The Assistant Control Panel features:

- alphanumeric control panel with an LCD display
- language selection for the display
- Start-up Assistant to ease drive commissioning
- copy function – parameters can be copied to the control panel memory for later transfer to other drives or for backup of a particular system.
- context sensitive help
- real time clock.

### Overview

The following table summarizes the key functions and displays on the Assistant Control Panel.

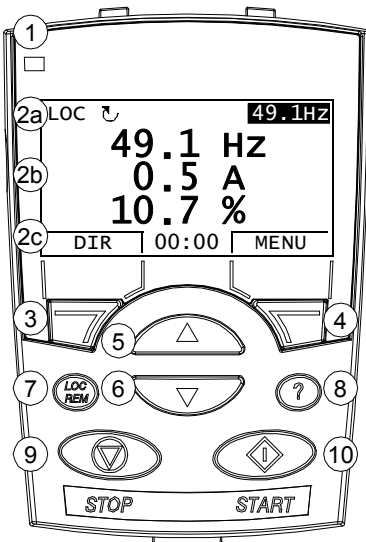

No.	Use
1	Status LED – Green for normal operation. If LED is flashing, or red, see section <a href="#">Diagnostic displays</a> on page 259.
2	LCD display – Divided into three main areas: <ol style="list-style-type: none"> <li>Status line – variable, depending on the mode of operation, see section <a href="#">Status line</a> on page 49.</li> <li>Center – variable; in general, shows signal and parameter values, menus or lists. Shows also faults and alarms.</li> <li>Bottom line – shows current functions of the two soft keys and, if enabled, the clock display.</li> </ol>
3	Soft key 1 – Function depends on the context. The text in the lower left corner of the LCD display indicates the function.
4	Soft key 2 – Function depends on the context. The text in the lower right corner of the LCD display indicates the function.
5	Up – <ul style="list-style-type: none"> <li>• Scrolls up through a menu or list displayed in the center of the LCD display.</li> <li>• Increments a value if a parameter is selected.</li> <li>• Increments the reference value if the upper right corner is highlighted. Holding the key down changes the value faster.</li> </ul>
6	Down – <ul style="list-style-type: none"> <li>• Scrolls down through a menu or list displayed in the center of the LCD display.</li> <li>• Decrements a value if a parameter is selected.</li> <li>• Decrements the reference value if the upper right corner is highlighted. Holding the key down changes the value faster.</li> </ul>
7	LOC/REM – Changes between local and remote control of the drive.
8	Help – Displays context sensitive information when the key is pressed. The information displayed describes the item currently highlighted in the center of the display.
9	STOP – Stops the drive in local control.
10	START – Starts the drive in local control.



### Status line

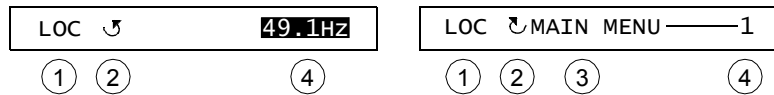

The top line of the LCD display shows the basic status information of the drive.



No.	Field	Alternatives	Significance
1	Control location	LOC	Drive control is local, that is, from the control panel.
		REM	Drive control is remote, such as the drive I/O or fieldbus.
2	State	↻	Forward shaft direction
		↺	Reverse shaft direction
		Rotating arrow	Drive is running at setpoint.
		Dotted rotating arrow	Drive is running but not at setpoint.
		Stationary arrow	Drive is stopped.
		Dotted stationary arrow	Start command is present, but the motor is not running, e.g. because start enable is missing.
3	Panel operation mode		<ul style="list-style-type: none"> <li>Name of the current mode</li> <li>Name of the list or menu shown</li> <li>Name of the operation state, e.g. PAR EDIT.</li> </ul>
4	Reference value or number of the selected item		<ul style="list-style-type: none"> <li>Reference value in the Output mode</li> <li>Number of the highlighted item, e.g mode, parameter group or fault.</li> </ul>

### Operation

You operate the control panel with menus and keys. The keys include two context-sensitive soft keys, whose current function is indicated by the text shown in the display above each key.

You select an option, e.g. operation mode or parameter, by scrolling the  and  arrow keys until the option is highlighted (in reverse video) and then pressing the relevant soft key. With the right soft key you usually enter a mode, accept an option or save the changes. The left soft key is used to cancel the made changes and return to the previous operation level.

The Assistant Control Panel has nine panel modes: Output, Parameters, Assistants, Changed Parameters, Fault Logger, Time and Date, Parameter Backup, I/O Settings and Fault. The operation in the first eight modes is described in this chapter. When a fault or alarm occurs, the panel goes automatically to the Fault mode showing the fault or alarm. You can reset it in the Output or Fault mode (see chapter [Diagnostics](#)).

Initially, the panel is in the Output mode, where you can start, stop, change the direction, switch between local and remote control, modify the reference value and monitor up to three actual values. To do other tasks, go first to the Main menu and select the appropriate mode on the menu. The status line (see section [Status line](#) on page 49) shows the name of the current menu, mode, item or state.





LOC ↻	49.1	49.1HZ
	0.5	A
	10.7	%
DIR	00:00	MENU
LOC ↻	MAIN MENU — 1	
<b>PARAMETERS</b>		
<b>ASSISTANTS</b>		
<b>CHANGED PAR</b>		
EXIT	00:00	ENTER

### How to do common tasks



The table below lists common tasks, the mode in which you can perform them and the page number where the steps to do the task are described in detail.

Task	Mode	Page
How to get help	Any	<a href="#">51</a>
How to find out the panel version	At power up	<a href="#">51</a>
How to adjust the display contrast	Output	<a href="#">54</a>
How to switch between local and remote control	Any	<a href="#">52</a>
How to start and stop the drive	Any	<a href="#">52</a>
How to change the direction of the motor rotation	Output	<a href="#">53</a>
How to set the speed, frequency or torque reference	Output	<a href="#">54</a>
How to change the value of a parameter	Parameters	<a href="#">55</a>
How to select the monitored signals	Parameters	<a href="#">56</a>
How to do guided tasks (specification of related parameter sets) with assistants	Assistants	<a href="#">57</a>
How to view and edit changed parameters	Changed Parameters	<a href="#">60</a>
How to view faults	Fault Logger	<a href="#">61</a>
How to reset faults and alarms	Output, Fault	<a href="#">265</a>
How to show/hide the clock, change date and time formats, set the clock and enable/disable automatic clock transitions according to the daylight saving changes	Time and Date	<a href="#">62</a>
How to copy parameters from the drive to the control panel	Parameter Backup	<a href="#">65</a>
How to restore parameters from the control panel to the drive	Parameter Backup	<a href="#">65</a>
How to view backup information	Parameter Backup	<a href="#">66</a>
How to edit and change parameter settings related to I/O terminals	I/O Settings	<a href="#">67</a>

*How to get help*









Step	Action	Display
1.	Press  to read the context-sensitive help text for the item that is highlighted.  If help text exists for the item, it is shown on the display.	<div style="border: 1px solid black; padding: 2px;">                     LOC ↵ PAR GROUPS — 10                      01 OPERATING DATA                      03 FB ACTUAL SIGNALS                      04 FAULT HISTORY                      10 START/STOP/DIR                      11 REFERENCE SELECT                      EXIT   00:00   SEL                 </div> <div style="border: 1px solid black; padding: 2px; margin-top: 5px;">                     LOC ↵ HELP                      This group defines external sources (EXT1 and EXT2) for commands that enable start, stop and                 </div>
2.	If the whole text is not visible, scroll the lines with keys  and  .	<div style="border: 1px solid black; padding: 2px;">                     LOC ↵ HELP                      external sources (EXT1 and EXT2) for commands that enable start, stop and direction changes.                      EXIT   00:00                   </div>
3.	After reading the text, return to the previous display by pressing  .	<div style="border: 1px solid black; padding: 2px;">                     LOC ↵ PAR GROUPS — 10                      01 OPERATING DATA                      03 FB ACTUAL SIGNALS                      04 FAULT HISTORY                      10 START/STOP/DIR                      11 REFERENCE SELECT                      EXIT   00:00   SEL                 </div>

*How to find out the panel version*

Step	Action	Display
1.	If the power is switched on, switch it off.	
2.	Keep key  pressed down while you switch on the power and read the information. The display shows the following panel information:  Panel FW: panel firmware version ROM CRC: panel ROM check sum Flash Rev: flash content version Flash content comment.  When you release the  key, the panel goes to the Output mode.	<div style="border: 1px solid black; padding: 2px;">                     PANEL VERSION INFO                      Panel FW:           x.xx                      ROM CRC:    xxxxxxxxxx                      Flash Rev:     x.xx                      xxxxxxxxxxxxxxxxxxxxxxxx                 </div>

### How to start, stop and switch between local and remote control

You can start, stop and switch between local and remote control in any mode. To be able to start or stop the drive, the drive must be in local control.

Step	Action	Display
1.	<ul style="list-style-type: none"> <li>To switch between remote control (REM shown on the status line) and local control (LOC shown on the status line), press .</li> </ul> <p><b>Note:</b> Switching to local control can be disabled with parameter <b>1606</b> LOCAL LOCK.</p> <p>The very first time the drive is powered up, it is in remote control (REM) and controlled through the drive I/O terminals. To switch to local control (LOC) and control the drive using the control panel, press . The result depends on how long you press the key:</p> <ul style="list-style-type: none"> <li>If you release the key immediately (the display flashes “Switching to the local control mode”), the drive stops. Set the local control reference as instructed on page <a href="#">54</a>.</li> <li>If you press the key for about two seconds, the drive continues as before. The drive copies the current remote values for the run/stop status and the reference, and uses them as the initial local control settings.</li> </ul> <ul style="list-style-type: none"> <li>To stop the drive in local control, press .</li> <li>To start the drive in local control, press .</li> </ul>	<div data-bbox="1098 367 1420 525" style="border: 1px solid black; padding: 5px;"> <p>LOC  MESSAGE Switching to the local control mode.</p> <hr/> <p style="text-align: center;">00:00</p> </div> <p>The arrow ( or ) on the status line stops rotating.</p> <p>The arrow ( or ) on the status line starts rotating. It is dotted until the drive reaches the setpoint.</p>

### Output mode

In the Output mode, you can:



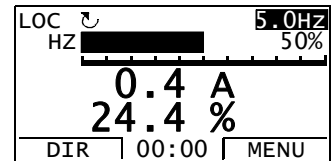
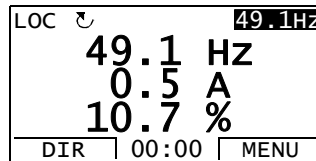

- monitor actual values of up to three signals in *Group 01: OPERATING DATA*
- change the direction of the motor rotation
- set the speed, frequency or torque reference
- adjust the display contrast
- start, stop, change the direction and switch between local and remote control.

You get to the Output mode by pressing  repeatedly.





The top right corner of the display shows the reference value. The center can be configured to show up to three signal values or bar graphs. If just one or two signals are selected for display, the number and name of each displayed signal are shown in addition to the value or bar graph. See page 56 for instructions on selecting and modifying the monitored signals.





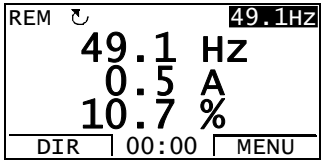

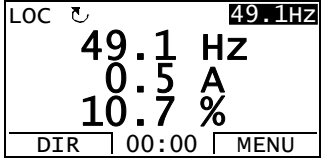
#### How to change the direction of the motor rotation

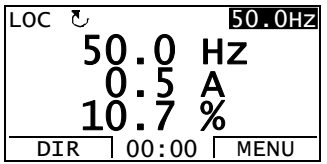
Step	Action	Display
1.	If you are not in the Output mode, press  repeatedly until you get there.	
2.	If the drive is in remote control (REM shown on the status line), switch to local control by pressing  . The display briefly shows a message about changing the mode and then returns to the Output mode.	
3.	To change the direction from forward (  shown on the status line) to reverse (  shown on the status line), or vice versa, press  .  <b>Note:</b> Parameter 1003 DIRECTION must be set to 3 (REQUEST).	

### How to set the speed, frequency or torque reference

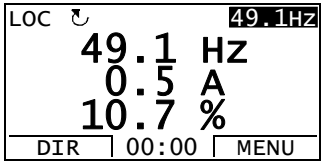
Step	Action	Display
1.	If you are not in the Output mode, press  repeatedly until you get there.	
2.	If the drive is in remote control (REM shown on the status line), switch to local control by pressing  . The display briefly shows a message about changing the mode and then returns to the Output mode. <b>Note:</b> With <a href="#">Group 11: REFERENCE SELECT</a> , you can allow the reference modification in remote control.	
3.	<ul style="list-style-type: none"> <li>To increase the highlighted reference value shown in the top right corner of the display, press . The value changes immediately. It is stored in the drive permanent memory and restored automatically after power switch-off.</li> <li>To decrease the value, press .</li> </ul>	

### How to adjust the display contrast

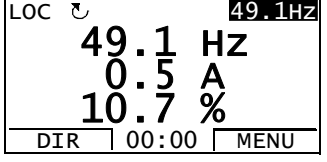













Step	Action	Display
1.	If you are not in the Output mode, press  repeatedly until you get there.	
2.	<ul style="list-style-type: none"> <li>To increase the contrast, press keys  and  simultaneously.</li> <li>To decrease the contrast, press keys  and  simultaneously.</li> </ul>	

### Parameters mode

In the Parameters mode, you can:

- view and change parameter values
- start, stop, change the direction and switch between local and remote control.

#### How to select a parameter and change its value

Step	Action	Display
1.	Go to the Main menu by pressing  if you are in the Output mode, otherwise by pressing  repeatedly until you get to the Main menu.	<pre> LOC ↵ MAIN MENU — 1 <b>PARAMETERS</b> <b>ASSISTANTS</b> <b>CHANGED PAR</b> EXIT   00:00   ENTER                     </pre>
2.	Go to the Parameters mode by selecting PARAMETERS on the menu with keys  and  , and pressing  .	<pre> LOC ↵ PAR GROUPS — 01 <b>01 OPERATING DATA</b> 03 FB ACTUAL SIGNALS 04 FAULT HISTORY 10 START/STOP/DIR 11 REFERENCE SELECT EXIT   00:00   SEL                     </pre>
3.	Select the appropriate parameter group with keys  and  .  Press  .	<pre> LOC ↵ PAR GROUPS — 99 <b>99 START-UP DATA</b> 01 OPERATING DATA 03 FB ACTUAL SIGNALS 04 FAULT HISTORY 10 START/STOP/DIR EXIT   00:00   SEL                     </pre> <pre> LOC ↵ PARAMETERS — <b>9901 LANGUAGE</b> <b>ENGLISH</b> 9902 APPLIC MACRO 9904 MOTOR CTRL MODE 9905 MOTOR NOM VOLT EXIT   00:00   EDIT                     </pre>
4.	Select the appropriate parameter with keys  and  . The current value of the parameter is shown below the selected parameter.  Press  .	<pre> LOC ↵ PARAMETERS — 9901 LANGUAGE <b>9902 APPLIC MACRO</b> <b>ABB STANDARD</b> 9904 MOTOR CTRL MODE 9905 MOTOR NOM VOLT EXIT   00:00   EDIT                     </pre> <pre> LOC ↵ PAR EDIT — 9902 APPLIC MACRO <b>ABB STANDARD</b> [1] CANCEL   00:00   SAVE                     </pre>
5.	Specify a new value for the parameter with keys  and  . Pressing the key once increments or decrements the value. Holding the key down changes the value faster. Pressing the keys simultaneously replaces the displayed value with the default value.	<pre> LOC ↵ PAR EDIT — 9902 APPLIC MACRO <b>3-WIRE</b> [2] CANCEL   00:00   SAVE                     </pre>
6.	<ul style="list-style-type: none"> <li>• To save the new value, press .</li> <li>• To cancel the new value and keep the original, press .</li> </ul>	<pre> LOC ↵ PARAMETERS — 9901 LANGUAGE <b>9902 APPLIC MACRO</b> <b>3-WIRE</b> 9904 MOTOR CTRL MODE 9905 MOTOR NOM VOLT EXIT   00:00   EDIT                     </pre>

### How to select the monitored signals

Step	Action	Display
1.	<p>You can select which signals are monitored in the Output mode and how they are displayed with <a href="#">Group 34: PANEL DISPLAY</a> parameters. See page 55 for detailed instructions on changing parameter values.</p> <p>By default, the display shows three signals. The particular default signals depend on the value of parameter <a href="#">9902</a> APPLIC MACRO: For macros whose default value of parameter <a href="#">9904</a> MOTOR CTRL MODE is 1 (VECTOR:SPEED), the default for signal 1 is <a href="#">0102</a> SPEED, otherwise <a href="#">0103</a> OUTPUT FREQ. The defaults for signals 2 and 3 are always <a href="#">0104</a> CURRENT and <a href="#">0105</a> TORQUE, respectively.</p> <p>To change the default signals, select up to three signals from <a href="#">Group 01: OPERATING DATA</a> to be shown.</p> <p>Signal 1: Change the value of parameter <a href="#">3401</a> SIGNAL1 PARAM to the index of the signal parameter in <a href="#">Group 01: OPERATING DATA</a> (= number of the parameter without the leading zero), e.g. 105 means parameter <a href="#">0105</a> TORQUE. Value 100 means that no signal is displayed.</p> <p>Repeat for signals 2 (<a href="#">3408</a> SIGNAL2 PARAM) and 3 (<a href="#">3415</a> SIGNAL3 PARAM).</p>	<div data-bbox="1098 283 1417 443"> <p>LOC <input type="checkbox"/> PAR EDIT <input type="checkbox"/></p> <p>3401 SIGNAL1 PARAM <b>OUTPUT FREQ</b> [103] CANCEL 00:00 SAVE</p> </div> <div data-bbox="1098 451 1417 611"> <p>LOC <input type="checkbox"/> PAR EDIT <input type="checkbox"/></p> <p>3408 SIGNAL2 PARAM <b>CURRENT</b> [104] CANCEL 00:00 SAVE</p> </div> <div data-bbox="1098 619 1417 779"> <p>LOC <input type="checkbox"/> PAR EDIT <input type="checkbox"/></p> <p>3415 SIGNAL3 PARAM <b>TORQUE</b> [105] CANCEL 00:00 SAVE</p> </div>
2.	<p>Select how you want the signals to be displayed: as a decimal number or a bar graph. For decimal numbers, you can specify the decimal point location, or use the decimal point location and unit of the source signal [setting (9 (DIRECT))]. For details, see parameter <a href="#">3404</a>.</p> <p>Signal 1: parameter <a href="#">3404</a> OUTPUT1 DSP FORM Signal 2: parameter <a href="#">3411</a> OUTPUT2 DSP FORM Signal 3: parameter <a href="#">3418</a> OUTPUT3 DSP FORM.</p>	<div data-bbox="1098 823 1417 982"> <p>LOC <input type="checkbox"/> PAR EDIT <input type="checkbox"/></p> <p>3404 OUTPUT1 DSP FORM <b>DIRECT</b> [9] CANCEL 00:00 SAVE</p> </div>
3.	<p>Select the units to be displayed for the signals. This has no effect if parameter <a href="#">3404/3411/3418</a> is set to 9 (DIRECT). For details, see parameter <a href="#">3405</a>.</p> <p>Signal 1: parameter <a href="#">3405</a> OUTPUT1 UNIT Signal 2: parameter <a href="#">3412</a> OUTPUT2 UNIT Signal 3: parameter <a href="#">3419</a> OUTPUT3 UNIT.</p>	<div data-bbox="1098 1075 1417 1234"> <p>LOC <input type="checkbox"/> PAR EDIT <input type="checkbox"/></p> <p>3405 OUTPUT1 UNIT <b>HZ</b> [3] CANCEL 00:00 SAVE</p> </div>
4.	<p>Select the scalings for the signals by specifying the minimum and maximum display values. This has no effect if parameter <a href="#">3404/3411/3418</a> is set to 9 (DIRECT). For details, see parameters <a href="#">3406</a> and <a href="#">3407</a>.</p> <p>Signal 1: parameters <a href="#">3406</a> OUTPUT1 MIN and <a href="#">3407</a> OUTPUT1 MAX Signal 2: parameters <a href="#">3413</a> OUTPUT2 MIN and <a href="#">3414</a> OUTPUT2 MAX Signal 3: parameters <a href="#">3420</a> OUTPUT3 MIN and <a href="#">3421</a> OUTPUT3 MAX.</p>	<div data-bbox="1098 1264 1417 1423"> <p>LOC <input type="checkbox"/> PAR EDIT <input type="checkbox"/></p> <p>3406 OUTPUT1 MIN <b>0.0 HZ</b> CANCEL 00:00 SAVE</p> </div> <div data-bbox="1098 1432 1417 1591"> <p>LOC <input type="checkbox"/> PAR EDIT <input type="checkbox"/></p> <p>3407 OUTPUT1 MAX <b>500.0 HZ</b> CANCEL 00:00 SAVE</p> </div>



### Assistants mode

















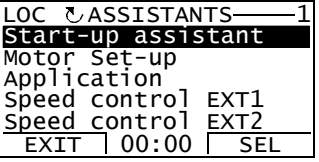

When the drive is first powered up, the Start-up Assistant guides you through the setup of the basic parameters. The Start-up Assistant is divided into assistants, each of which guides you through the task of specifying a related parameter set, for example Motor Set-up or PID Control. You can activate the assistants one after the other as the Start-up Assistant suggests, or independently. The tasks of the assistants are listed in the table on page 58.

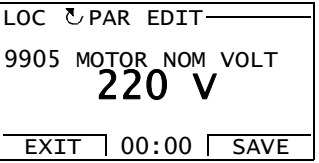
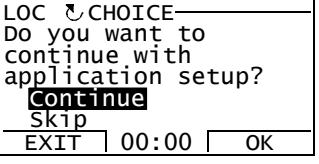

In the Assistants mode, you can:

- use assistants to guide you through the specification of a set of basic parameters
- start, stop, change the direction and switch between local and remote control.

#### How to use an assistant

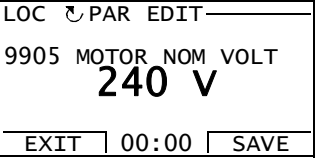
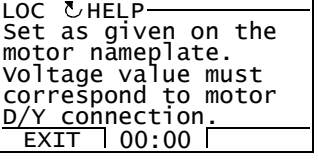
The table below shows the basic operation sequence which leads you through assistants. The Motor Set-up Assistant is used as an example.

Step	Action	Display
1.	Go to the Main menu by pressing  if you are in the Output mode, otherwise by pressing  repeatedly until you get to the Main menu.	
2.	Go to the Assistants mode by selecting ASSISTANTS on the menu with keys  and  , and pressing  .	
3.	Select the assistant with keys  and  , and press  . If you select any other assistant than the Start-up Assistant, it guides you through the task of specification of its parameter set as shown in steps 4. and 5. below. After that you can select another assistant on the Assistants menu or exit the Assistants mode. The Motor Set-up Assistant is used here as an example.  If you select the Start-up Assistant, it activates the first assistant, which guides you through the task of specification of its parameter set as shown in steps 4. and 5. below. The Start-up Assistant then asks if you want to continue with the next assistant or skip it – select the appropriate answer with keys  and  , and press  . If you choose to skip, the Start-up Assistant asks the same question about the next assistant, and so on.	 
4.	<ul style="list-style-type: none"> <li>• To specify a new value, press keys  and .</li> <li>• To ask for information on the requested parameter, press key . Scroll the help text with keys  and . Close the help by pressing .</li> </ul>	 

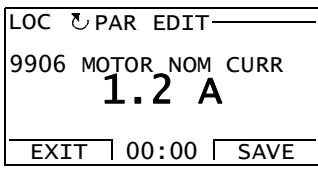
Step	Action	Display
5.	<ul style="list-style-type: none"> <li>To accept the new value and continue to the setting of the next parameter, press .</li> <li>To stop the assistant, press .</li> </ul>	

The table below lists the tasks of the assistants and the relevant drive parameters. Depending on the selection made in the Application task (parameter [9902](#) APPLIC MACRO), the Start-up Assistant decides, which consequent tasks it suggests.

Name	Description	Set parameters
<b>Language select</b>	Selecting the language	<a href="#">9901</a>
<b>Motor set-up</b>	Setting the motor data Performing the motor identification. (If the speed limits are not in the allowed range: Setting the limits.)	<a href="#">9904...9909</a> <a href="#">9910</a>
<b>Application</b>	Selecting the application macro	<a href="#">9902</a> , parameters associated to the macro
<b>Option modules</b>	Activating the option modules	<a href="#">Group 35: MOTOR TEMP MEAS</a> <a href="#">Group 52: PANEL COMM</a> <a href="#">9802</a>
<b>Speed control EXT1</b>	Selecting the source for the speed reference (If AI1 is used: Setting analog input AI1 limits, scale, inversion) Setting the reference limits Setting the speed (frequency) limits Setting the acceleration and deceleration times	<a href="#">1103</a> ( <a href="#">1301...1303</a> , <a href="#">3001</a> ) <a href="#">1104</a> , <a href="#">1105</a> <a href="#">2001</a> , <a href="#">2002</a> , ( <a href="#">2007</a> , <a href="#">2008</a> ) <a href="#">2202</a> , <a href="#">2203</a>
<b>Speed control EXT2</b>	Selecting the source for the speed reference (If AI1 is used: Setting analog input AI1 limits, scale, inversion) Setting the reference limits	<a href="#">1106</a> ( <a href="#">1301...1303</a> , <a href="#">3001</a> ) <a href="#">1107</a> , <a href="#">1108</a>
<b>Torque control</b>	Selecting the source for the torque reference (If AI1 is used: Setting analog input AI1 limits, scale, inversion) Setting the reference limits Setting the torque ramp up and ramp down times	<a href="#">1106</a> ( <a href="#">1301...1303</a> , <a href="#">3001</a> ) <a href="#">1107</a> , <a href="#">1108</a> <a href="#">2401</a> , <a href="#">2402</a>
<b>PID control</b>	Selecting the source for the process reference (If AI1 is used: Setting analog input AI1 limits, scale, inversion) Setting the reference limits Setting the speed (reference) limits Setting the source and limits for the process actual value	<a href="#">1106</a> ( <a href="#">1301...1303</a> , <a href="#">3001</a> ) <a href="#">1107</a> , <a href="#">1108</a> <a href="#">2001</a> , <a href="#">2002</a> , ( <a href="#">2007</a> , <a href="#">2008</a> ) <a href="#">4016</a> , <a href="#">4018</a> , <a href="#">4019</a>
<b>Start/Stop control</b>	Selecting the source for start and stop signals of the two external control locations, EXT1 and EXT2 Selecting between EXT1 and EXT2 Defining the direction control Defining the start and stop modes Selecting the use of Run Enable signal	<a href="#">1001</a> , <a href="#">1002</a>  <a href="#">1102</a> <a href="#">1003</a> <a href="#">2101...2103</a> <a href="#">1601</a>
<b>Timed functions</b>	Setting the timed functions Selecting the timed start/stop control for external control locations EXT1 and EXT2 Selecting timed EXT1/EXT2 control Activation of timed constant speed 1	<a href="#">Group 36: TIMED FUNCTIONS</a> <a href="#">1001</a> , <a href="#">1002</a>  <a href="#">1102</a> <a href="#">1201</a>













Name	Description	Set parameters
	Selecting timed function status indicated through relay output RO Selecting timed PID1 parameter set 1/2 control	<a href="#">1401</a> <a href="#">4027</a>
<b>Protections</b>	Setting the current and torque limits	<a href="#">2003, 2017</a>
<b>Output signals</b>	Selecting the signals indicated through relay output RO Selecting the signals indicated through analog output AO Setting the minimum, maximum, scaling and inversion	<a href="#">Group 14: RELAY OUTPUTS</a> <a href="#">Group 15: ANALOG OUTPUTS</a>

## Changed Parameters mode

In the Changed Parameters mode, you can:

- view a list of all parameters that have been changed from the macro default values
- change these parameters
- start, stop, change the direction and switch between local and remote control.

### How to view and edit changed parameters













Step	Action	Display
1.	Go to the Main menu by pressing  if you are in the Output mode, otherwise by pressing  repeatedly until you get to the Main menu.	<pre> LOC  MAIN MENU 1 PARAMETERS ASSISTANTS CHANGED PAR EXIT 00:00 ENTER </pre>
2.	Go to the Changed Parameters mode by selecting CHANGED PAR on the menu with keys  and  , and pressing  .	<pre> LOC  CHANGED PAR 1202 CONST SPEED 1       10.0 HZ 1203 CONST SPEED 2 1204 CONST SPEED 3 9902 APPLIC MACRO EXIT 00:00 EDIT </pre>
3.	Select the changed parameter on the list with keys  and  . The value of the selected parameter is shown below it. Press  to modify the value.	<pre> LOC  PAR EDIT 1202 CONST SPEED 1       10.0 HZ CANCEL 00:00 SAVE </pre>
4.	Specify a new value for the parameter with keys  and  . Pressing the key once increments or decrements the value. Holding the key down changes the value faster. Pressing the keys simultaneously replaces the displayed value with the default value.	<pre> LOC  PAR EDIT 1202 CONST SPEED 1       15.0 HZ CANCEL 00:00 SAVE </pre>
5.	<ul style="list-style-type: none"> <li>• To accept the new value, press . If the new value is the default value, the parameter is removed from the list of changed parameters.</li> <li>• To cancel the new value and keep the original, press .</li> </ul>	<pre> LOC  CHANGED PAR 1202 CONST SPEED 1       15.0 HZ 1203 CONST SPEED 2 1204 CONST SPEED 3 9902 APPLIC MACRO EXIT 00:00 EDIT </pre>

### Fault Logger mode

In the Fault Logger mode, you can:

- view the drive fault history of maximum ten faults (after a power off, only the three latest faults are kept in the memory)
- see the details of the three latest faults (after a power off, the details of only the most recent fault is kept in the memory)
- read the help text for the fault
- start, stop, change the direction and switch between local and remote control.

#### How to view faults

Step	Action	Display
1.	Go to the Main menu by pressing  if you are in the Output mode, otherwise by pressing  repeatedly until you get to the Main menu.	<pre> LOC ↵ MAIN MENU ——— 1 PARAMETERS ASSISTANTS CHANGED PAR EXIT   00:00   ENTER                     </pre>
2.	Go to the Fault Logger mode by selecting FAULT LOGGER on the menu with keys  and  , and pressing  . The display shows the fault log starting with the latest fault.  The number on the row is the fault code according to which the causes and corrective actions are listed in chapter <i>Diagnostics</i> .	<pre> LOC ↵ FAULT LOGGER ——— 10: PANEL LOSS    19.03.05 13:04:57 6: DC UNDERVOLT 6: AI1 LOSS EXIT   00:00   DETAIL                     </pre>
3.	To see the details of a fault, select it with keys  and  , and press  .	<pre> LOC ↵ PANEL LOSS ——— FAULT 10 FAULT TIME 1    13:04:57 FAULT TIME 2 EXIT   00:00   DIAG                     </pre>
4.	To show the help text, press  . Scroll the help text with keys  and  .  After reading the help, press  to return to the previous display.	<pre> LOC ↵ DIAGNOSTICS ——— Check: Comm lines and connections, parameter 3002, parameters in groups 10 and 11. EXIT   00:00   OK                     </pre>

















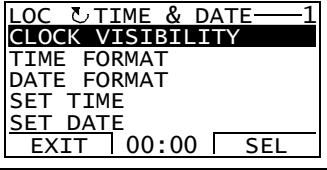





## Time and Date mode









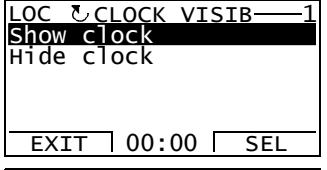
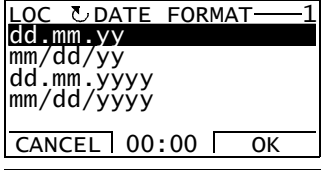
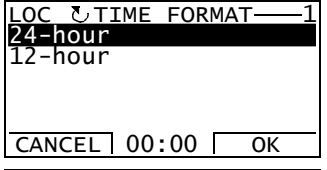
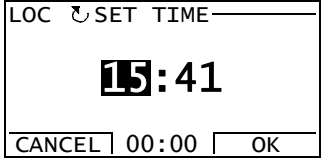



In the Time and Date mode, you can:

- show or hide the clock
- change date and time display formats
- set the date and time
- enable or disable automatic clock transitions according to the daylight saving changes
- start, stop, change the direction and switch between local and remote control.

The Assistant Control Panel contains a battery to ensure the function of the clock when the panel is not powered by the drive.

*How to show or hide the clock, change display formats, set the date and time and enable or disable clock transitions due to daylight saving changes*

Step	Action	Display
1.	Go to the Main menu by pressing  if you are in the Output mode, otherwise by pressing  repeatedly until you get to the Main menu.	
2.	Go to the Time and Date mode by selecting TIME & DATE on the menu with keys  and  , and pressing  .	
3.	<ul style="list-style-type: none"> <li>• To show (hide) the clock, select CLOCK VISIBILITY on the menu, press , select Show clock (Hide clock) and press , or, if you want to return to the previous display without making changes, press .</li> <li>• To specify the date format, select DATE FORMAT on the menu, press , and select a suitable format. Press  to save or  to cancel your changes.</li> <li>• To specify the time format, select TIME FORMAT on the menu, press , and select a suitable format. Press  to save or  to cancel your changes.</li> <li>• To set the time, select SET TIME on the menu and press . Specify the hours with keys  and , and press . Then specify the minutes. Press  to save or  to cancel your changes.</li> </ul>	   

Step	Action	Display
	<ul style="list-style-type: none"> <li>To set the date, select SET DATE on the menu and press . Specify the first part of the date (day or month depending on the selected date format) with keys  and , and press . Repeat for the second part. After specifying the year, press . To cancel your changes, press .</li> <li>To enable or disable the automatic clock transitions according to the daylight saving changes, select DAYLIGHT SAVING on the menu and press . Pressing  opens the help that shows the beginning and end dates of the period during which daylight saving time is used in each country or area whose daylight saving changes you can select to be followed.</li> <li>To disable automatic clock transitions according to the daylight saving changes, select Off and press .</li> <li>To enable automatic clock transitions, select the country or area whose daylight saving changes are followed and press .</li> <li>To return to the previous display without making changes, press .</li> </ul>	<div data-bbox="1153 233 1471 394"> <p>LOC  SET DATE</p> <p><b>19.03.05</b></p> <p>CANCEL   00:00   OK</p> </div> <div data-bbox="1153 401 1471 562"> <p>LOC DAYLIGHT SAV—1</p> <p>Off</p> <p>EU</p> <p>US</p> <p>Australia1:NSW,vict..</p> <p>Australia2:Tasmania..</p> <p>EXIT   00:00   SEL</p> </div> <div data-bbox="1153 569 1471 730"> <p>LOC HELP</p> <p>EU:</p> <p>On: Mar last Sunday</p> <p>Off: Oct last Sunday</p> <p>US:</p> <p>EXIT   00:00  </p> </div>

## Parameter Backup mode

The Parameter Backup mode is used to export parameters from one drive to another or to make a backup of the drive parameters. Uploading to the panel stores all drive parameters, including up to two user sets, to the Assistant Control Panel. The full set, partial parameter set (application) and user sets can then be downloaded from the control panel to another drive or the same drive. Uploading and downloading can be performed in local control.

The control panel memory is non-volatile and does not depend on the panel battery.

In the Parameter Backup mode, you can:

- copy all parameters from the drive to the control panel (UPLOAD TO PANEL). This includes all defined user sets of parameters and internal (not adjustable by the user) parameters such as those created by the ID Run.
- view the information about the backup stored to the control panel with UPLOAD TO PANEL (BACKUP INFO). This includes e.g. the type and rating of the drive where the backup was made. It is useful to check this information when you are going to copy the parameters to another drive with DOWNLOAD FULL SET to ensure that the drives match.
- restore the full parameter set from the control panel to the drive (DOWNLOAD FULL SET). This writes all parameters, including the internal non-user-adjustable motor parameters, to the drive. It does not include the user sets of parameters.

**Note:** Only use this function to restore a drive from a backup or to transfer parameters to systems that are identical to the original system.

- copy a partial parameter set (part of the full set) from the control panel to a drive (DOWNLOAD APPLICATION). The partial set does not include user sets, internal motor parameters, parameters [9905...9909](#), [1605](#), [1607](#), [5201](#), nor any [Group 51: EXT COMM MODULE](#) and [Group 53: EFB PROTOCOL](#) parameters.

The source and target drives and their motor sizes do not need to be the same.

- copy USER S1 parameters from the control panel to the drive (DOWNLOAD USER SET1). A user set includes [Group 99: START-UP DATA](#) parameters and the internal motor parameters.















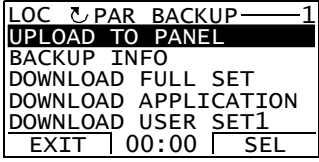

The function is only shown on the menu when User Set 1 has been first saved using parameter [9902](#) APPLIC MACRO (see section [User parameter sets](#) on page [88](#)) and then uploaded to the control panel with UPLOAD TO PANEL.

- copy USER S2 parameters from the control panel to the drive (DOWNLOAD USER SET2). As DOWNLOAD USER SET1 above.
- start, stop, change the direction and switch between local and remote control.







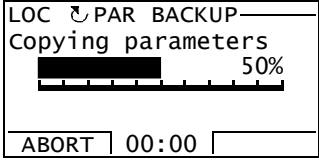
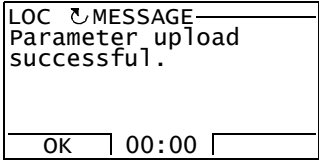
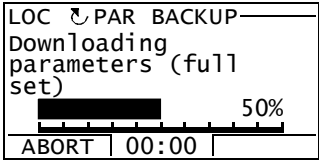
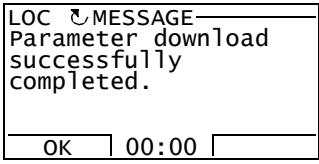





*How to upload and download parameters*

For the upload and download functions available, see above. Note that the drive has to be in local control for uploading and downloading.

Step	Action	Display
1.	Go to the Main menu by pressing  if you are in the Output mode, otherwise by pressing  repeatedly until you get to the Main menu. – If REM is shown on the status line, press  to switch to local control.	
2.	Go to the Par Backup mode by selecting PAR BACKUP on the menu with keys  and  , and pressing  .	
3.	<p>• To copy all parameters (including user sets and internal parameters) from the drive to the control panel, select UPLOAD TO PANEL on the Par Backup menu with keys  and , and press . During the transfer, the display shows the transfer status as a percentage of completion. Press  if you want to stop the operation.</p> <p>After the upload is completed, the display shows a message about the completion. Press  to return to the Par Backup menu.</p> <p>• To perform downloads, select the appropriate operation (here DOWNLOAD FULL SET is used as an example) on the Par Backup menu with keys  and , and press . The display shows the transfer status as a percentage of completion. Press  if you want stop the operation.</p> <p>After the download is completed, the display shows a message about the completion. Press  to return to the Par Backup menu.</p>	   

### How to view information about the backup















Step	Action	Display
1.	Go to the Main menu by pressing  if you are in the Output mode, otherwise by pressing  repeatedly until you get to the Main menu.	<pre> LOC  MAIN MENU-----1 PARAMETERS ASSISTANTS CHANGED PAR EXIT  00:00  ENTER </pre>
2.	Go to the Par Backup mode by selecting PAR BACKUP on the menu with keys  and  , and pressing  .	<pre> LOC  PAR BACKUP-----1 UPLOAD TO PANEL BACKUP INFO DOWNLOAD FULL SET DOWNLOAD APPLICATION DOWNLOAD USER SET1 EXIT  00:00  SEL </pre>
3.	<p>Select BACKUP INFO on the Par Backup menu with keys  and , and press . The display shows the following information about the drive where the backup was made:</p> <p>DRIVE TYPE:           type of the drive  DRIVE RATING:         rating of the drive in format XXXYZ, where                            XXX: nominal current rating. If present, an "A" indicates                                a decimal point, e.g. 4A6 means 4.6 A.                            Y:    2 = 200 V                                4 = 400 V                                6 = 600 V                            Z:    i = European loading package                                n = US loading package  FIRMWARE:             firmware version of the drive.</p> <p>You can scroll the information with keys  and .</p>	<pre> LOC  BACKUP INFO----- DRIVE TYPE ACS550 3304 DRIVE RATING 4A62i 3301 FIRMWARE EXIT  00:00 </pre> <pre> LOC  BACKUP INFO----- ACS550 3304 DRIVE RATING 4A62i 3301 FIRMWARE 300F hex EXIT  00:00 </pre>
4.	Press  to return to the Par Backup menu.	<pre> LOC  PAR BACKUP-----1 UPLOAD TO PANEL BACKUP INFO DOWNLOAD FULL SET DOWNLOAD APPLICATION DOWNLOAD USER SET1 EXIT  00:00  SEL </pre>

### I/O Settings mode

In the I/O Settings mode, you can:

- check the parameter settings related to any I/O terminal
- edit the parameter setting. For example, if “1103: REF1” is listed under Ain1 (Analog input 1), that is, parameter **1103** REF1 SELECT has value AI1, you can change its value to e.g. AI2. You cannot, however, set the value of parameter **1106** REF2 SELECT to AI1.
- start, stop, change the direction and switch between local and remote control.

#### How to edit and change parameter settings related to I/O terminals

Step	Action	Display
1.	Go to the Main menu by pressing  if you are in the Output mode, otherwise by pressing  repeatedly until you get to the Main menu.	<pre> LOC ↻ MAIN MENU — 1 PARAMETERS ASSISTANTS CHANGED PAR EXIT   00:00   ENTER                     </pre>
2.	Go the I/O Settings mode by selecting I/O SETTINGS on the menu with keys  and  , and pressing  .	<pre> LOC ↻ I/O SETTINGS — 1 DIGITAL INPUTS (DI) ANALOG INPUTS (AI) RELAY OUTPUTS (ROUT) ANALOG OUTPUTS (AOUT) PANEL EXIT   00:00   SEL                     </pre>
3.	Select the I/O group, e.g. DIGITAL INPUTS, with keys  and  , and press  . After a brief pause, the display shows the current settings for the selection.	<pre> LOC ↻ I/O SETTINGS — -DI1- 1001: START/STOP (E1) -DI2- - -DI3- EXIT   00:00                       </pre>
4.	Select the setting (line with a parameter number) with keys  and  , and press  .	<pre> LOC ↻ PAR EDIT — 1001 EXT1 COMMANDS DI1 [1] CANCEL   00:00   SAVE                     </pre>
5.	Specify a new value for the setting with keys  and  . Pressing the key once increments or decrements the value. Holding the key down changes the value faster. Pressing the keys simultaneously replaces the displayed value with the default value.	<pre> LOC ↻ PAR EDIT — 1001 EXT1 COMMANDS DI1, 2 [2] CANCEL   00:00   SAVE                     </pre>
6.	<ul style="list-style-type: none"> <li>• To save the new value, press .</li> <li>• To cancel the new value and keep the original, press .</li> </ul>	<pre> LOC ↻ I/O SETTINGS — -DI1- 1001: START/STOP (E1) -DI2- 1001: DIR (E1) -DI3- EXIT   00:00                       </pre>

## Basic Control Panel

### Features

The Basic Control Panel features:

- numeric control panel with an LCD display
- copy function – parameters can be copied to the control panel memory for later transfer to other drives or for backup of a particular system.

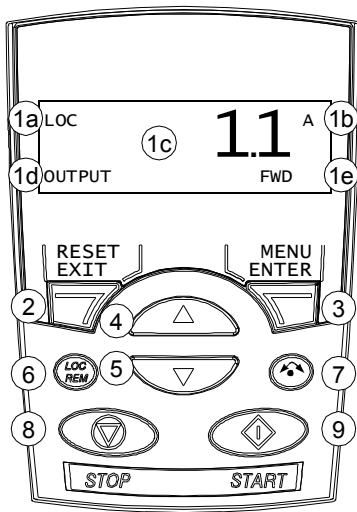

### Overview

The following table summarizes the key functions and displays on the Basic Control Panel.



No.	Use
1	<p>LCD display – Divided into five areas:</p> <p>a. Upper left – Control location:            LOC: drive control is local, that is, from the control panel            REM: drive control is remote, such as the drive I/O or fieldbus.</p> <p>b. Upper right – Unit of the displayed value.</p> <p>c. Center – Variable; in general, shows parameter and signal values, menus or lists. Shows also fault and alarm codes.</p> <p>d. Lower left and center – Panel operation state:            OUTPUT: Output mode            PAR: Parameter mode            MENU: Main menu  <b>FAULT</b>: Fault mode.</p> <p>e. Lower right – Indicators:            FWD (forward) / REV (reverse): direction of the motor rotation            Flashing slowly: stopped            Flashing rapidly: running, not at setpoint            Steady: running, at setpoint  <b>SET</b>: Displayed value can be modified (in the Parameter and Reference modes).</p>
2	RESET/EXIT – Exits to the next higher menu level without saving changed values. Resets faults in the Output and Fault modes.
3	MENU/ENTER – Enters deeper into menu level. In the Parameter mode, saves the displayed value as the new setting.
4	Up – <ul style="list-style-type: none"> <li>• Scrolls up through a menu or list.</li> <li>• Increases a value if a parameter is selected.</li> <li>• Increases the reference value in the Reference mode.</li> </ul> Holding the key down changes the value faster.
5	Down – <ul style="list-style-type: none"> <li>• Scrolls down through a menu or list.</li> <li>• Decreases a value if a parameter is selected.</li> <li>• Decreases the reference value in the Reference mode.</li> </ul> Holding the key down changes the value faster.
6	LOC/REM – Changes between local and remote control of the drive.
7	DIR – Changes the direction of the motor rotation.
8	STOP – Stops the drive in local control.
9	START – Starts the drive in local control.

## Operation

You operate the control panel with menus and keys. You select an option, e.g. operation mode or parameter, by scrolling the  and  arrow keys until the option is visible in the display and then pressing the  key.

With the  key, you return to the previous operation level without saving the made changes.

The Basic Control Panel has five panel modes: Output, Reference, Parameter, Copy and Fault. The operation in the first four modes is described in this chapter. When a fault or alarm occurs, the panel goes automatically to the Fault mode showing the fault or alarm code. You can reset the fault or alarm in the Output or Fault mode (see chapter [Diagnostics](#)).

After the power is switched on, the panel is in the Output mode, where you can start, stop, change the direction, switch between local and remote control and monitor up to three actual values (one at a time). To do other tasks, go first to the Main menu and select the appropriate mode.

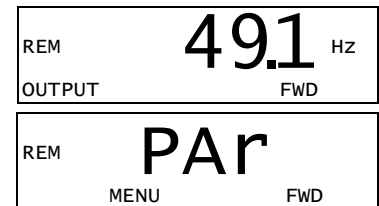





### How to do common tasks

The table below lists common tasks, the mode in which you can perform them and the page number where the steps to do the task are described in detail.

Task	Mode	Page
How to switch between local and remote control	Any	<a href="#">70</a>
How to start and stop the drive	Any	<a href="#">70</a>
How to change the direction of the motor rotation	Any	<a href="#">70</a>
How to browse the monitored signals	Output	<a href="#">71</a>
How to set the speed, frequency or torque reference	Reference	<a href="#">72</a>
How to change the value of a parameter	Parameter	<a href="#">73</a>
How to select the monitored signals	Parameter	<a href="#">74</a>
How to reset faults and alarms	Output, Fault	<a href="#">265</a>
How to copy parameters from the drive to the control panel	Copy	<a href="#">76</a>
How to restore parameters from the control panel to the drive	Copy	<a href="#">76</a>



*How to start, stop and switch between local and remote control*

You can start, stop and switch between local and remote control in any mode. To be able to start or stop the drive, the drive must be in local control.

Step	Action	Display
1.	<ul style="list-style-type: none"> <li>To switch between remote control (REM shown on the left) and local control (LOC shown on the left), press .</li> <li><b>Note:</b> Switching to local control can be disabled with parameter <b>1606</b> LOCAL LOCK.</li> </ul> <p>After pressing the key, the display briefly shows message "LoC" or "rE", as appropriate, before returning to the previous display.</p> <p>The very first time the drive is powered up, it is in remote control (REM) and controlled through the drive I/O terminals. To switch to local control (LOC) and control the drive using the control panel, press . The result depends on how long you press the key:</p> <ul style="list-style-type: none"> <li>If you release the key immediately (the display flashes "LoC"), the drive stops. Set the local control reference as instructed on page <b>72</b>.</li> <li>If you press the key for about two seconds (release when the display changes from "LoC" to "LoC r"), the drive continues as before. The drive copies the current remote values for the run/stop status and the reference, and uses them as the initial local control settings.</li> </ul> <ul style="list-style-type: none"> <li>To stop the drive in local control, press .</li> <li>To start the drive in local control, press .</li> </ul>	<div style="border: 1px solid black; padding: 5px; margin-bottom: 10px;">             LOC <span style="float: right;">49.1 Hz</span>              OUTPUT <span style="float: right;">FWD</span> </div> <div style="border: 1px solid black; padding: 5px;">             LOC <span style="float: right; font-size: 2em;">LoC</span>  <span style="float: right;">FWD</span> </div> <p>Text FWD or REV on the bottom line starts flashing slowly.</p> <p>Text FWD or REV on the bottom line starts flashing rapidly. It stops flashing when the drive reaches the setpoint.</p>

*How to change the direction of the motor rotation*

You can change the direction of the motor rotation in any mode.

Step	Action	Display
1.	<p>If the drive is in remote control (REM shown on the left), switch to local control by pressing . The display briefly shows message "LoC" before returning to the previous display.</p>	<div style="border: 1px solid black; padding: 5px;">             LOC <span style="float: right;">49.1 Hz</span>              OUTPUT <span style="float: right;">FWD</span> </div>
2.	<p>To change the direction from forward (FWD shown at the bottom) to reverse (REV shown at the bottom), or vice versa, press .</p> <p><b>Note:</b> Parameter <b>1003</b> DIRECTION must be set to 3 (REQUEST).</p>	<div style="border: 1px solid black; padding: 5px;">             LOC <span style="float: right;">49.1 Hz</span>              OUTPUT <span style="float: right;">REV</span> </div>

### Output mode

In the Output mode, you can:



- monitor actual values of up to three *Group 01: OPERATING DATA* signals, one signal at a time
- start, stop, change the direction and switch between local and remote control.

You get to the Output mode by pressing  until the display shows text OUTPUT at the bottom.

The display shows the value of one *Group 01: OPERATING DATA* signal. The unit is shown on the right. Page 74 tells how to select up to three signals to be monitored in the Output mode. The table below shows how to view them one at a time.

REM	<b>49.1</b> Hz
OUTPUT	FWD

#### How to browse the monitored signals













Step	Action	Display												
1.	<p>If more than one signals have been selected to be monitored (see page 74), you can browse them in the Output mode.</p> <p>To browse the signals forward, press key  repeatedly. To browse them backward, press key  repeatedly.</p>	<table border="1"> <tr> <td>REM</td> <td style="text-align: center;"><b>49.1</b> Hz</td> </tr> <tr> <td>OUTPUT</td> <td style="text-align: center;">FWD</td> </tr> </table> <table border="1"> <tr> <td>REM</td> <td style="text-align: center;"><b>0.5</b> A</td> </tr> <tr> <td>OUTPUT</td> <td style="text-align: center;">FWD</td> </tr> </table> <table border="1"> <tr> <td>REM</td> <td style="text-align: center;"><b>10.7</b> %</td> </tr> <tr> <td>OUTPUT</td> <td style="text-align: center;">FWD</td> </tr> </table>	REM	<b>49.1</b> Hz	OUTPUT	FWD	REM	<b>0.5</b> A	OUTPUT	FWD	REM	<b>10.7</b> %	OUTPUT	FWD
REM	<b>49.1</b> Hz													
OUTPUT	FWD													
REM	<b>0.5</b> A													
OUTPUT	FWD													
REM	<b>10.7</b> %													
OUTPUT	FWD													

## Reference mode

In the Reference mode, you can:

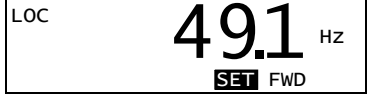
- set the speed, frequency or torque reference
- start, stop, change the direction and switch between local and remote control.

### How to set the speed, frequency or torque reference

Step	Action	Display
1.	Go to the Main menu by pressing  if you are in the Output mode, otherwise by pressing  repeatedly until you see MENU at the bottom.	
2.	If the drive is in remote control (REM shown on the left), switch to local control by pressing  . The display briefly shows "LoC" before switching to local control. <b>Note:</b> With <a href="#">Group 11: REFERENCE SELECT</a> , you can allow the reference modification in remote control (REM).	
3.	If the panel is not in the Reference mode ("rEF" not visible), press key  or  until you see "rEF" and then press  . Now the display shows the current reference value with <b>SET</b> under the value.	 
4.	<ul style="list-style-type: none"> <li>• To increase the reference value, press .</li> <li>• To decrease the reference value, press .</li> </ul> The value changes immediately when you press the key. It is stored in the drive permanent memory and restored automatically after power switch-off.	



















**Parameter mode**

In the Parameter mode, you can:

- view and change parameter values
- select and modify the signals shown in the Output mode
- start, stop, change the direction and switch between local and remote control.

*How to select a parameter and change its value*

Step	Action	Display
1.	Go to the Main menu by pressing  if you are in the Output mode, otherwise by pressing  repeatedly until you see MENU at the bottom.	<div style="border: 1px solid black; padding: 5px;">                     LOC <span style="font-size: 2em; font-weight: bold;">rEF</span>                      MENU <span style="float: right;">FWD</span> </div>
2.	If the panel is not in the Parameter mode ("PAR" not visible), press key  or  until you see "PAR" and then press  . The display shows the number of one of the parameter groups.	<div style="border: 1px solid black; padding: 5px;">                     LOC <span style="font-size: 2em; font-weight: bold;">PAR</span>                      MENU <span style="float: right;">FWD</span> </div> <div style="border: 1px solid black; padding: 5px; margin-top: 5px;">                     LOC <span style="font-size: 2em; font-weight: bold;">-01-</span>                      PAR <span style="float: right;">FWD</span> </div>
3.	Use keys  and  to find the desired parameter group.	<div style="border: 1px solid black; padding: 5px;">                     LOC <span style="font-size: 2em; font-weight: bold;">-11-</span>                      PAR <span style="float: right;">FWD</span> </div>
4.	Press  . The display shows one of the parameters in the selected group.	<div style="border: 1px solid black; padding: 5px;">                     LOC <span style="font-size: 2em; font-weight: bold;">1101</span>                      PAR <span style="float: right;">FWD</span> </div>
5.	Use keys  and  to find the desired parameter.	<div style="border: 1px solid black; padding: 5px;">                     LOC <span style="font-size: 2em; font-weight: bold;">1103</span>                      PAR <span style="float: right;">FWD</span> </div>
6.	Press and hold  for about two seconds until the display shows the value of the parameter with <b>SET</b> underneath indicating that changing of the value is now possible. <b>Note:</b> When <b>SET</b> is visible, pressing keys  and  simultaneously changes the displayed value to the default value of the parameter.	<div style="border: 1px solid black; padding: 5px;">                     LOC <span style="font-size: 2em; font-weight: bold;">1</span>                      PAR <b>SET</b> FWD                 </div>
7.	Use keys  and  to select the parameter value. When you have changed the parameter value, <b>SET</b> starts flashing.  • To save the displayed parameter value, press  . • To cancel the new value and keep the original, press  .	<div style="border: 1px solid black; padding: 5px;">                     LOC <span style="font-size: 2em; font-weight: bold;">2</span>                      PAR <b>SET</b> FWD                 </div> <div style="border: 1px solid black; padding: 5px; margin-top: 5px;">                     LOC <span style="font-size: 2em; font-weight: bold;">1103</span>                      PAR <span style="float: right;">FWD</span> </div>

### How to select the monitored signals

Step	Action	Display
1.	<p>You can select which signals are monitored in the Output mode and how they are displayed with <a href="#">Group 34: PANEL DISPLAY</a> parameters. See page <a href="#">55</a> for detailed instructions on changing parameter values.</p> <p>By default, you can monitor three signals by browsing (see page <a href="#">71</a>). The particular default signals depend on the value of parameter <a href="#">9902</a> APPLIC MACRO: For macros whose default value of parameter <a href="#">9904</a> MOTOR CTRL MODE is 1 (VECTOR:SPEED), the default for signal 1 is <a href="#">0102</a> SPEED, otherwise <a href="#">0103</a> OUTPUT FREQ. The defaults for signals 2 and 3 are always <a href="#">0104</a> CURRENT and <a href="#">0105</a> TORQUE, respectively.</p> <p>To change the default signals, select from <a href="#">Group 01: OPERATING DATA</a> up to three signals to be browsed.</p> <p>Signal 1: Change the value of parameter <a href="#">3401</a> SIGNAL1 PARAM to the index of the signal parameter in <a href="#">Group 01: OPERATING DATA</a> (= number of the parameter without the leading zero), e.g. 105 means parameter <a href="#">0105</a> TORQUE. Value 100 means that no signal is displayed.</p> <p>Repeat for signals 2 (<a href="#">3408</a> SIGNAL2 PARAM) and 3 (<a href="#">3415</a> SIGNAL3 PARAM). For example, if <a href="#">3401</a> = 0 and <a href="#">3415</a> = 0, browsing is disabled and only the signal specified by <a href="#">3408</a> appears in the display. If all three parameters are set to 0, i.e. no signals are selected for monitoring, the panel displays text "n.A".</p>	<div style="border: 1px solid black; padding: 5px; margin-bottom: 5px;">LOC <span style="font-size: 2em; font-weight: bold;">103</span> PAR <span style="border: 1px solid black; padding: 2px;">SET</span> FWD</div> <div style="border: 1px solid black; padding: 5px; margin-bottom: 5px;">LOC <span style="font-size: 2em; font-weight: bold;">104</span> PAR <span style="border: 1px solid black; padding: 2px;">SET</span> FWD</div> <div style="border: 1px solid black; padding: 5px;">LOC <span style="font-size: 2em; font-weight: bold;">105</span> PAR <span style="border: 1px solid black; padding: 2px;">SET</span> FWD</div>
2.	<p>Specify the decimal point location, or use the decimal point location and unit of the source signal [setting 9 (DIRECT)]. Bar graphs are not available for Basic Operation Panel. For details, see parameter <a href="#">3404</a>.</p> <p>Signal 1: parameter <a href="#">3404</a> OUTPUT1 DSP FORM Signal 2: parameter <a href="#">3411</a> OUTPUT2 DSP FORM Signal 3: parameter <a href="#">3418</a> OUTPUT3 DSP FORM.</p>	<div style="border: 1px solid black; padding: 5px;">LOC <span style="font-size: 2em; font-weight: bold;">9</span> PAR <span style="border: 1px solid black; padding: 2px;">SET</span> FWD</div>
3.	<p>Select the units to be displayed for the signals. This has no effect if parameter <a href="#">3404/3411/3418</a> is set to 9 (DIRECT). For details, see parameter <a href="#">3405</a>.</p> <p>Signal 1: parameter <a href="#">3405</a> OUTPUT1 UNIT Signal 2: parameter <a href="#">3412</a> OUTPUT2 UNIT Signal 3: parameter <a href="#">3419</a> OUTPUT3 UNIT.</p>	<div style="border: 1px solid black; padding: 5px;">LOC <span style="font-size: 2em; font-weight: bold;">3</span> PAR <span style="border: 1px solid black; padding: 2px;">SET</span> FWD</div>
4.	<p>Select the scalings for the signals by specifying the minimum and maximum display values. This has no effect if parameter <a href="#">3404/3411/3418</a> is set to 9 (DIRECT). For details, see parameters <a href="#">3406</a> and <a href="#">3407</a>.</p> <p>Signal 1: parameters <a href="#">3406</a> OUTPUT1 MIN and <a href="#">3407</a> OUTPUT1 MAX Signal 2: parameters <a href="#">3413</a> OUTPUT2 MIN and <a href="#">3414</a> OUTPUT2 MAX Signal 3: parameters <a href="#">3420</a> OUTPUT3 MIN and <a href="#">3421</a> OUTPUT3 MAX.</p>	<div style="border: 1px solid black; padding: 5px; margin-bottom: 5px;">LOC <span style="font-size: 2em; font-weight: bold;">0.0</span> Hz PAR <span style="border: 1px solid black; padding: 2px;">SET</span> FWD</div> <div style="border: 1px solid black; padding: 5px;">LOC <span style="font-size: 2em; font-weight: bold;">500.0</span> Hz PAR <span style="border: 1px solid black; padding: 2px;">SET</span> FWD</div>

## Copy mode

The Basic Control Panel can store a full set of drive parameters and up to two user sets of drive parameters to the control panel. The control panel memory is non-volatile.

In the Copy mode, you can:

- copy all parameters from the drive to the control panel (uL – Upload). This includes all defined user sets of parameters and internal (not adjustable by the user) parameters such as those created by the ID Run.
- restore the full parameter set from the control panel to the drive (dL A – Download All). This writes all parameters, including the internal non-user-adjustable motor parameters, to the drive. It does not include the user sets of parameters.

**Note:** Only use this function to restore a drive, or to transfer parameters to systems that are identical to the original system.

- copy a partial parameter set from the control panel to a drive (dL P – Download Partial). The partial set does not include user sets, internal motor parameters, parameters [9905...9909](#), [1605](#), [1607](#), [5201](#), nor any [Group 51: EXT COMM MODULE](#) and [Group 53: EFB PROTOCOL](#) parameters.

The source and target drives and their motor sizes do not need to be the same.











- copy USER S1 parameters from the control panel to the drive (dL u1 – Download User Set 1). A user set includes [Group 99: START-UP DATA](#) parameters and the internal motor parameters.

The function is only shown on the menu when User Set 1 has been first saved using parameter [9902](#) APPLIC MACRO (see section [User parameter sets](#) on page [88](#)) and then uploaded to panel.

- copy USER S2 parameters from the control panel to the drive (dL u2 – Download User Set 2). As dL u1 – Download User Set 1 above.
- start, stop, change the direction and switch between local and remote control.

### How to upload and download parameters

For the upload and download functions available, see above.

Step	Action	Display
1.	Go to the Main menu by pressing  if you are in the Output mode, otherwise by pressing  repeatedly until you see MENU at the bottom.	<div style="border: 1px solid black; padding: 5px;">           LOC  <div style="text-align: center; font-size: 2em; font-weight: bold;">PAR</div> <div style="display: flex; justify-content: space-between; font-size: 0.8em;"> <span>MENU</span> <span>FWD</span> </div> </div>
2.	<p>If the panel is not in the Copy mode ("CoPY" not visible), press key  or  until you see "CoPY".</p> <p>Press .</p>	<div style="border: 1px solid black; padding: 5px;">           LOC  <div style="text-align: center; font-size: 2em; font-weight: bold;">CoPY</div> <div style="display: flex; justify-content: space-between; font-size: 0.8em;"> <span>MENU</span> <span>FWD</span> </div> </div> <div style="border: 1px solid black; padding: 5px; margin-top: 5px;">           LOC  <div style="text-align: center; font-size: 2em; font-weight: bold;">dL u1</div> <div style="display: flex; justify-content: space-between; font-size: 0.8em;"> <span>MENU</span> <span>FWD</span> </div> </div>
3.	<ul style="list-style-type: none"> <li>To upload all parameters (including user sets) from the drive to the control panel, step to "uL" with keys  and .</li> </ul> <p>Press . During the transfer, the display shows the transfer status as a percentage of completion.</p> <ul style="list-style-type: none"> <li>To perform downloads, step to the appropriate operation (here "dL A", Download All, is used as an example) with keys  and .</li> </ul> <p>Press . During the transfer, the display shows the transfer status as a percentage of completion.</p>	<div style="border: 1px solid black; padding: 5px; margin-bottom: 5px;">           LOC  <div style="text-align: center; font-size: 2em; font-weight: bold;">uL</div> <div style="display: flex; justify-content: space-between; font-size: 0.8em;"> <span>MENU</span> <span>FWD</span> </div> </div> <div style="border: 1px solid black; padding: 5px; margin-bottom: 5px;">           LOC  <div style="text-align: center; font-size: 2em; font-weight: bold;">uL 50 %</div> <div style="display: flex; justify-content: space-between; font-size: 0.8em;"> <span>MENU</span> <span>FWD</span> </div> </div> <div style="border: 1px solid black; padding: 5px; margin-bottom: 5px;">           LOC  <div style="text-align: center; font-size: 2em; font-weight: bold;">dL A</div> <div style="display: flex; justify-content: space-between; font-size: 0.8em;"> <span>MENU</span> <span>FWD</span> </div> </div> <div style="border: 1px solid black; padding: 5px;">           LOC  <div style="text-align: center; font-size: 2em; font-weight: bold;">dL 50 %</div> <div style="display: flex; justify-content: space-between; font-size: 0.8em;"> <span>MENU</span> <span>FWD</span> </div> </div>

### Basic Control Panel alarm codes

In addition to the faults and alarms generated by the drive (see chapter [Diagnostics](#)), the Basic Control Panel indicates control panel alarms with a code of form A5xxx. See section [Alarm codes \(Basic Control Panel\)](#) on page 269 for a list of the alarm codes and descriptions.

# Application macros

---

Macros change a group of parameters to new, predefined values. Use macros to minimize the need for manual editing of parameters. Selecting a macro sets all other parameters to their default values, except:

- [Group 99: START-UP DATA](#) parameters (except parameter [9904](#))
- [1602](#) PARAMETER LOCK
- [1607](#) PARAM SAVE
- [3018](#) COMM FAULT FUNC and [3019](#) COMM FAULT TIME
- [9802](#) COMM PROT SEL
- [Group 50: ENCODER](#) ... [Group 53: EFB PROTOCOL](#) parameters
- [Group 29: MAINTENANCE TRIG](#) parameters.

After selecting a macro, you can make additional parameter changes manually with the control panel.

You enable application macros by setting the value for parameter [9902](#) APPLIC MACRO. By default, 1, ABB STANDARD, is the enabled macro.

The following sections describe each of the application macros and provide a connection example for each macro.

The last section in this chapter, [Macro default values for parameters](#), lists the parameters that the macros change and the default values established by each macro.

## ABB Standard macro

This is the default macro. It provides a general purpose, 2-wire I/O configuration, with three (3) constant speeds. Parameter values are the default values defined in section [Complete parameter list](#) on page 91.

Connection example:

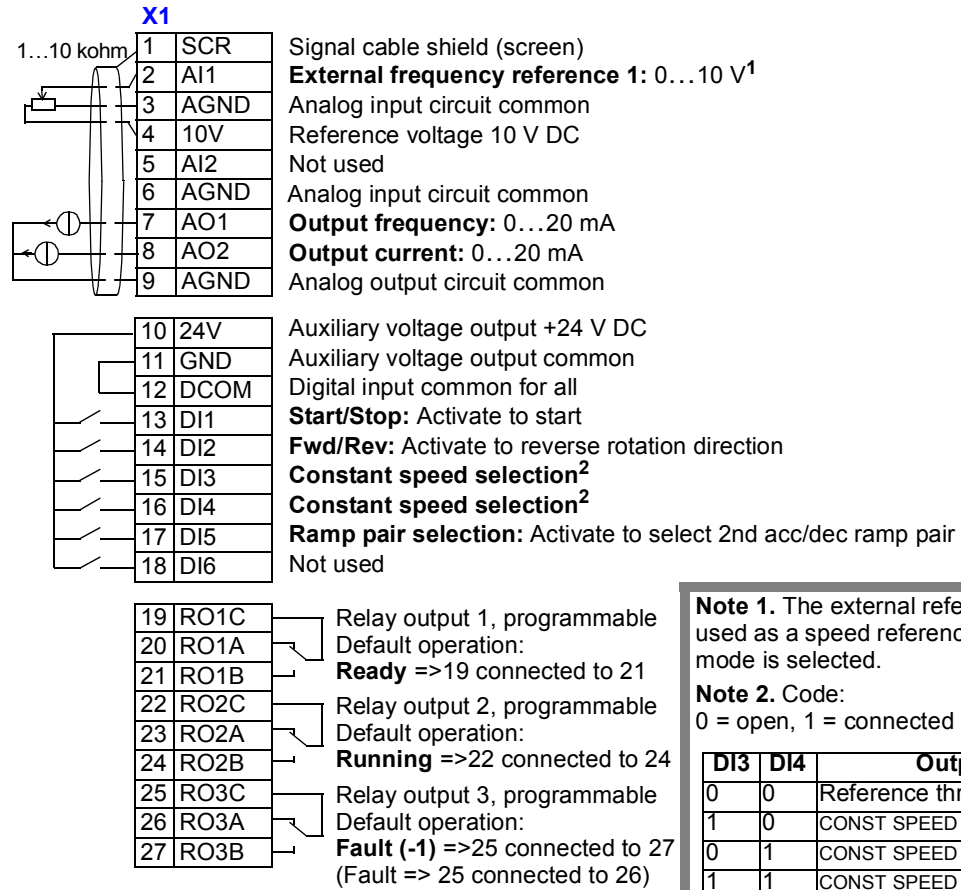

**Note 1.** The external reference is used as a speed reference if a vector mode is selected.

**Note 2.** Code:  
0 = open, 1 = connected

DI3	DI4	Output
0	0	Reference through AI1
1	0	CONST SPEED 1 (1202)
0	1	CONST SPEED 2 (1203)
1	1	CONST SPEED 3 (1204)

- |   |   |  |
|---|---|--|
| <p><b>Input signals</b></p> <ul style="list-style-type: none"> <li>• Analog reference (AI1)</li> <li>• Start, stop and direction (DI1,2)</li> <li>• Constant speed selection (DI3,4)</li> <li>• Ramp pair (1 of 2) selection (DI5)</li> </ul> | <p><b>Output signals</b></p> <ul style="list-style-type: none"> <li>• Analog output AO1: Frequency</li> <li>• Analog output AO2: Current</li> <li>• Relay output 1: Ready</li> <li>• Relay output 2: Running</li> <li>• Relay output 3: Fault (-1)</li> </ul> | <p><b>Jumper setting</b></p> <p>AI1: 0...10 V<br/>AI2: 0(4)...20 mA</p> <p>or</p> <p>AI1: 0...10 V<br/>AI2: 0(4)...20 mA</p> |
|---|---|--|

### 3-wire macro

This macro is used when the drive is controlled using momentary push-buttons. It provides three (3) constant speeds. To enable, set the value of parameter 9902 to 2 (3-WIRE).

**Note:** When the stop input (DI2) is deactivated (no input), the control panel start/stop buttons are disabled.

Connection example:

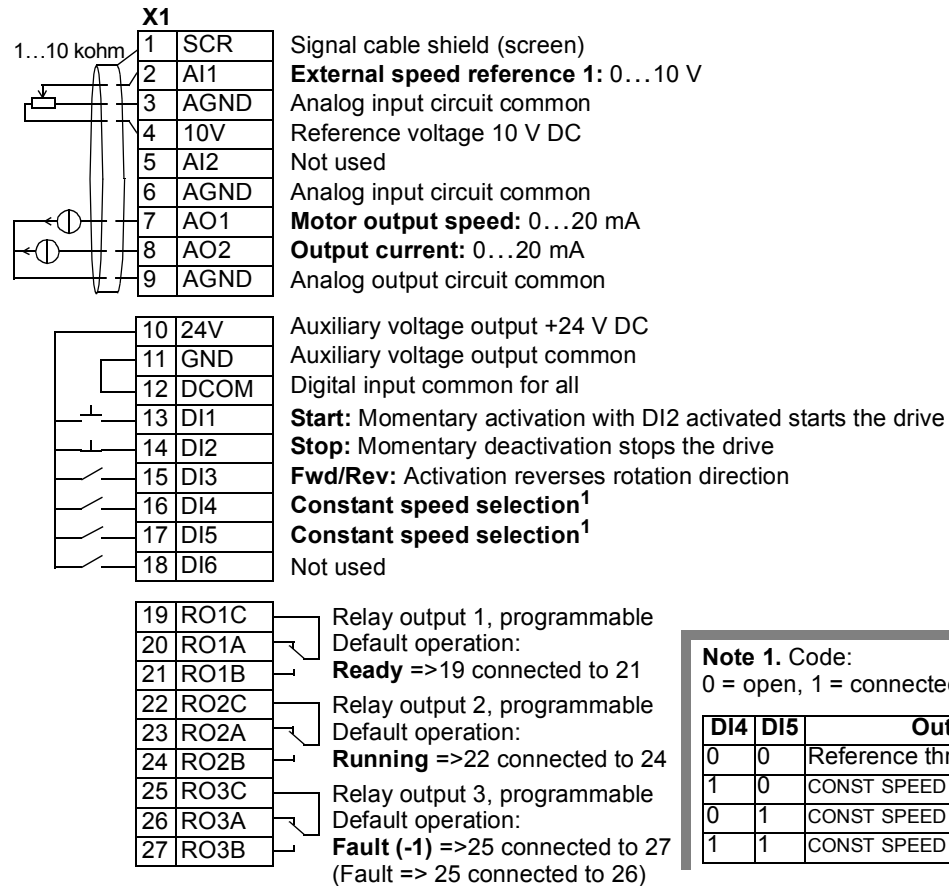

**Note 1. Code:**  
0 = open, 1 = connected

DI4	DI5	Output
0	0	Reference through AI1
1	0	CONST SPEED 1 (1202)
0	1	CONST SPEED 2 (1203)
1	1	CONST SPEED 3 (1204)

- Input signals**
- Analog reference (AI1)
  - Start, stop and direction (DI1,2,3)
  - Constant speed selection (DI4,5)

- Output signals**
- Analog output AO1: Speed
  - Analog output AO2: Current
  - Relay output 1: Ready
  - Relay output 2: Running
  - Relay output 3: Fault (-1)

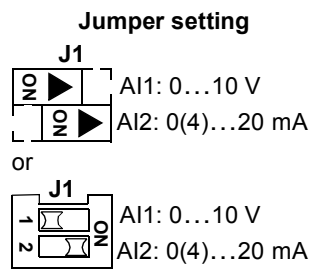

## Alternate macro

This macro provides an I/O configuration adopted to a sequence of DI control signals used when alternating the rotation direction of the motor. To enable, set the value of parameter 9902 to 3 (ALTERNATE).

Connection example:

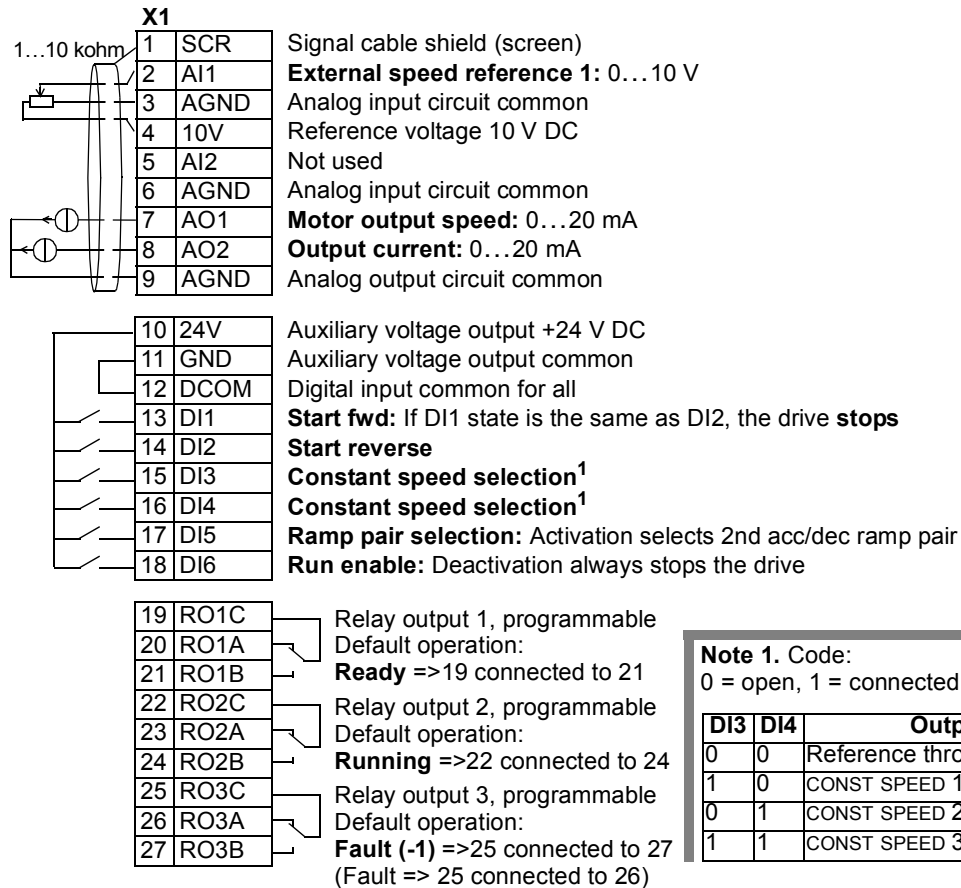

**Note 1. Code:**  
0 = open, 1 = connected

DI3	DI4	Output
0	0	Reference through AI1
1	0	CONST SPEED 1 (1202)
0	1	CONST SPEED 2 (1203)
1	1	CONST SPEED 3 (1204)

### Input signals

- Analog reference (AI1)
- Start, stop and direction (DI1,2)
- Constant speed selection (DI3,4)
- Ramp pair 1/2 selection (DI5)
- Run enable (DI6)

### Output signals

- Analog output AO1: Speed
- Analog output AO2: Current
- Relay output 1: Ready
- Relay output 2: Running
- Relay output 3: Fault (-1)

### Jumper setting

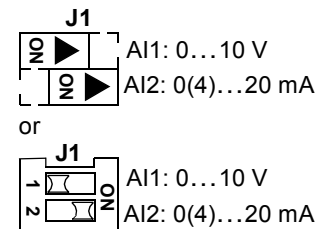



## Motor Potentiometer macro

This macro provides a cost-effective interface for PLCs that vary the speed of the motor using only digital signals. To enable, set the value of parameter 9902 to 4 (MOTOR POT).

Connection example:

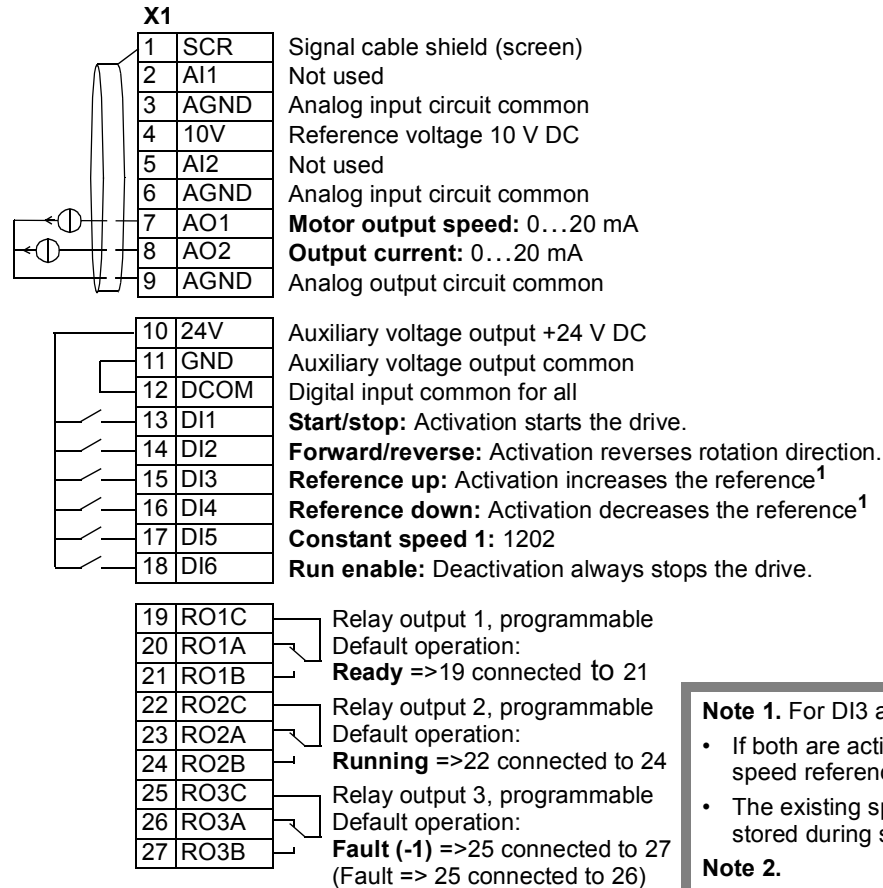

**Note 1.** For DI3 and DI4:

- If both are active or inactive the speed reference is unchanged.
- The existing speed reference is stored during stop or power down.

**Note 2.**

- Settings of the ramp times with acceleration and deceleration time 2 (parameters 2205 and 2206).

- |  |   |
|--|---|
| <p><b>Input signals</b></p> <ul style="list-style-type: none"> <li>• Start, stop and direction (DI1,2)</li> <li>• Reference up/down (DI3,4)</li> <li>• Constant speed selection (DI5)</li> <li>• Run enable (DI6)</li> </ul> | <p><b>Output signals</b></p> <ul style="list-style-type: none"> <li>• Analog output AO1: Speed</li> <li>• Analog output AO2: Current</li> <li>• Relay output 1: Ready</li> <li>• Relay output 2: Running</li> <li>• Relay output 3: Fault (-1)</li> </ul> |
|--|---|

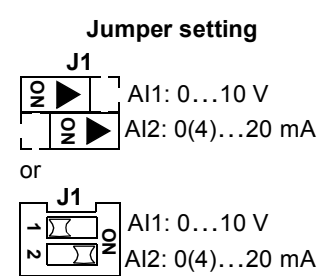

## Hand-Auto macro

This macro provides an I/O configuration that is typically used in HVAC applications. To enable, set the value of parameter 9902 to 5 (HAND/AUTO).

**Note:** Parameter 2108 START INHIBIT must remain in the default setting, 0 (OFF).

Connection example:

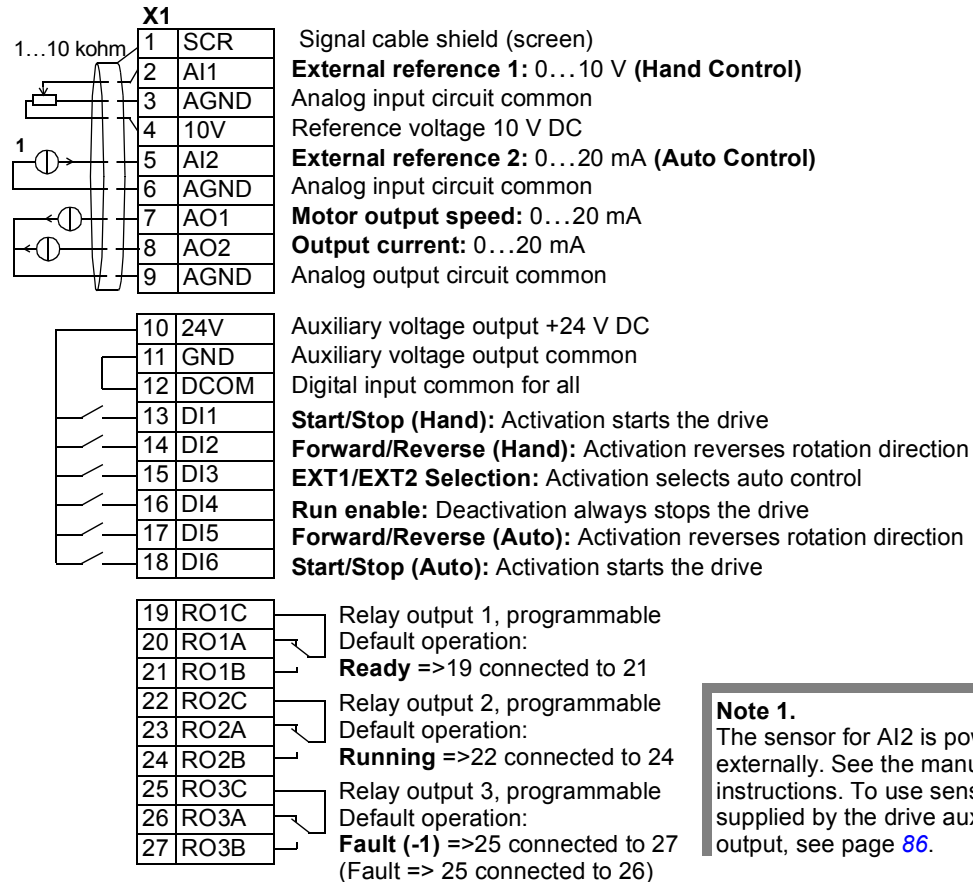

**Note 1.**  
The sensor for AI2 is powered externally. See the manufacturer's instructions. To use sensors supplied by the drive aux. voltage output, see page 86.

- Input signals**
- Two analog references (AI1, 2)
  - Start/stop – hand/auto (DI1, 6)
  - Direction – hand/auto (DI2, 5)
  - Control location selection (DI3)
  - Run enable (DI4)

- Output signals**
- Analog output AO1: Speed
  - Analog output AO2: Current
  - Relay output 1: Ready
  - Relay output 2: Running
  - Relay output 3: Fault (-1)

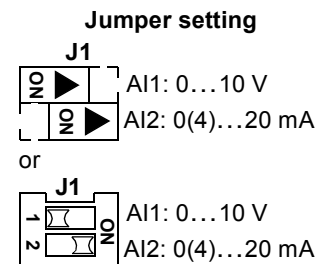

## PID Control macro

This macro provides parameter settings for closed-loop control systems such as pressure control, flow control, etc. To enable, set the value of parameter 9902 to 6 (PID CONTROL).

**Note:** Parameter 2108 START INHIBIT must remain in the default setting, 0 (OFF).

Connection example:

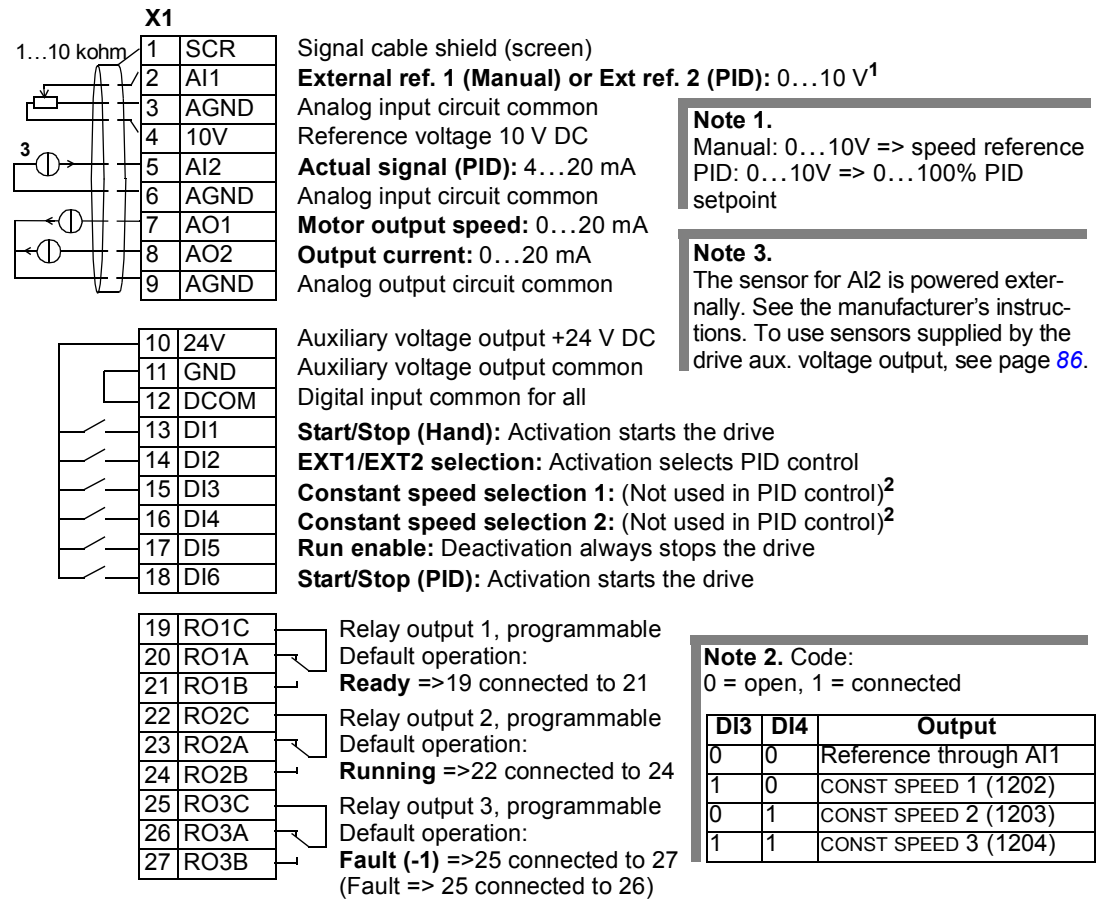

### Input signals

- Analog reference (AI1)
- Actual value (AI2)
- Start/stop – hand/PID (DI1, 6)
- EXT1/EXT2 selection (DI2)
- Constant speed selection (DI3, 4)
- Run enable (DI5)

### Output signals

- Analog output AO1: Speed
- Analog output AO2: Current
- Relay output 1: Ready
- Relay output 2: Running
- Relay output 3: Fault (-1)

### Jumper setting

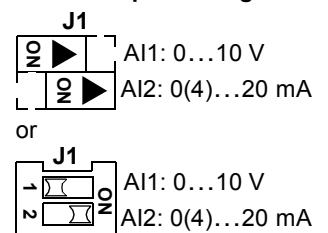

**Note:** Use the following switch-on order:

1. EXT1/EXT2
2. Run Enable
3. Start.

## PFC macro

This macro provides parameter settings for pump and fan control (PFC) applications. To enable, set the value of parameter 9902 to 7 (PFC CONTROL).

**Note:** Parameter 2108 START INHIBIT must remain in the default setting, 0 (OFF).

Connection example:

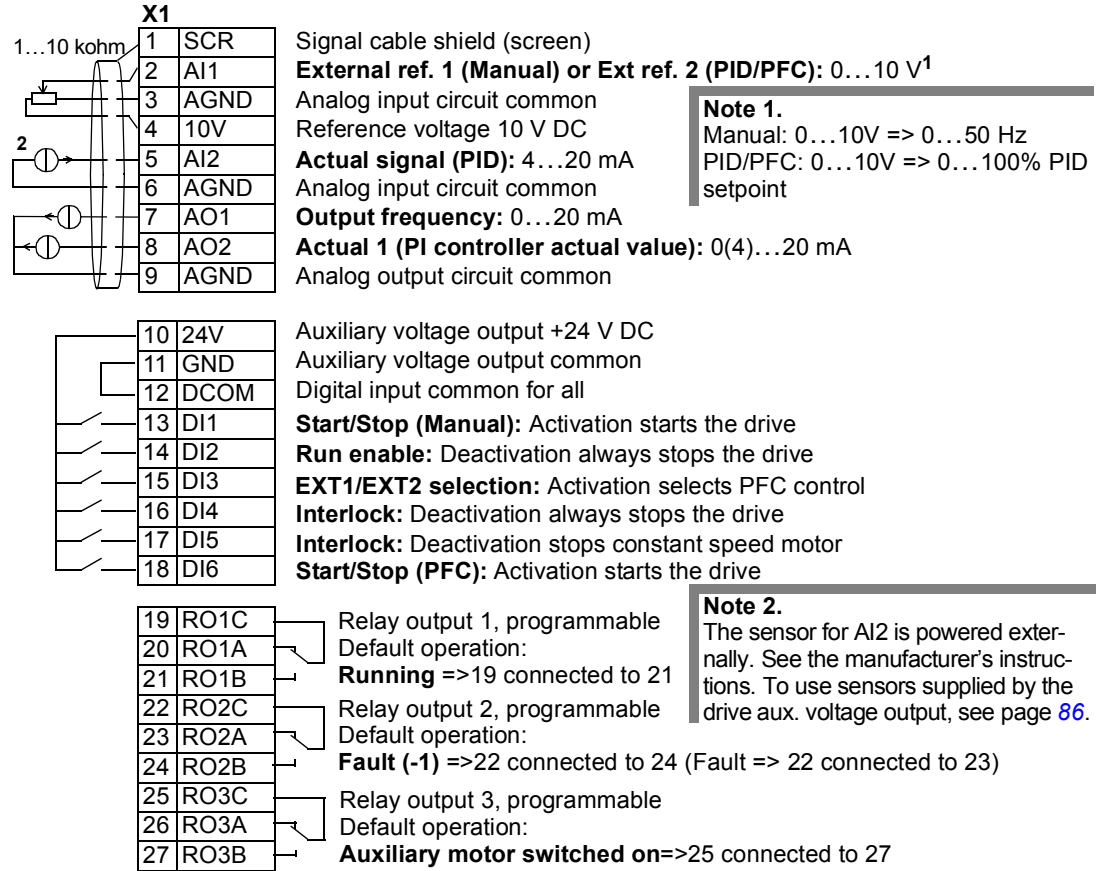

**Note 1.**  
 Manual: 0...10V => 0...50 Hz  
 PID/PFC: 0...10V => 0...100% PID setpoint

**Note 2.**  
 The sensor for AI2 is powered externally. See the manufacturer's instructions. To use sensors supplied by the drive aux. voltage output, see page 86.

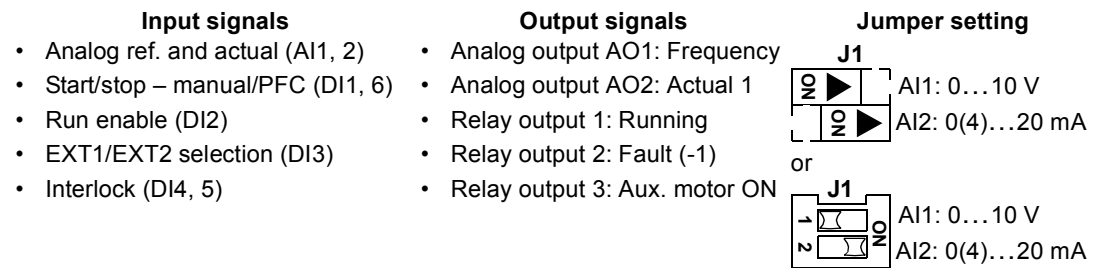

**Note:** Use the following switch-on order:  
 1. EXT1/EXT2  
 2. Run Enable  
 3. Start.

## Torque Control macro

This macro provides parameter settings for applications that require torque control of the motor. Control can also be switched to speed control. To enable, set the value of parameter 9902 to 8 (TORQUE CTRL).

Connection example:

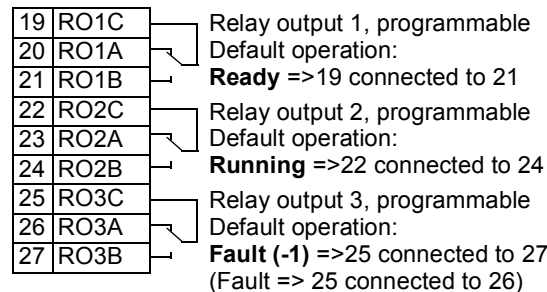
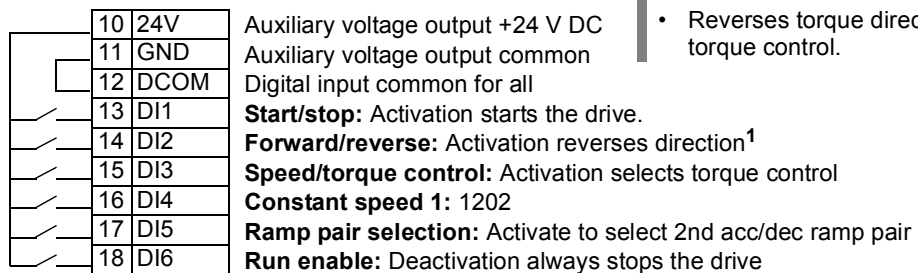
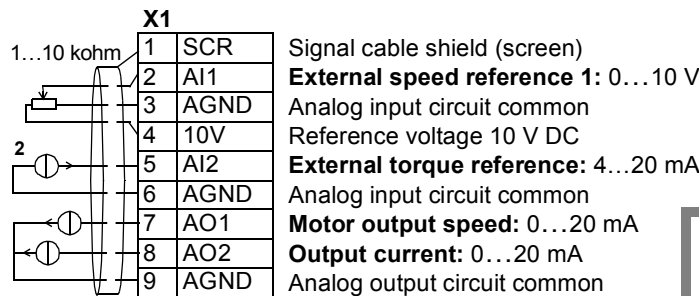

**Note 1.**

- Reverses rotation direction in speed control.
- Reverses torque direction in torque control.

**Note 2.**

The sensor for AI2 is powered externally. See the manufacturer's instructions. To use sensors supplied by the drive aux. voltage output, see page 86.

**Input signals**

- Two analog references (AI1, 2)
- Start/stop and direction (DI1, 2)
- Speed/torque control (DI3)
- Constant speed selection (DI4)
- Ramp pair 1/2 selection (DI5)
- Run enable (DI6)

**Output signals**

- Analog output AO1: Speed
- Analog output AO2: Current
- Relay output 1: Ready
- Relay output 2: Running
- Relay output 3: Fault (-1)

**Jumper setting**

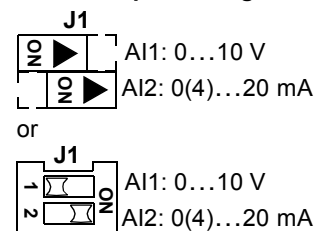

## Connection examples of two-wire and three-wire sensors

Many applications use process PI(D) and need a feedback signal from the process. The feedback signal is typically connected to analog input 2 (AI2).

The macro wiring diagrams for each macro earlier in this chapter use an externally powered sensor (connections not shown). The figures below give examples of connections using a two-wire or three-wire sensor/transmitter supplied by the drive auxiliary voltage output.

### Two-wire sensor/transmitter

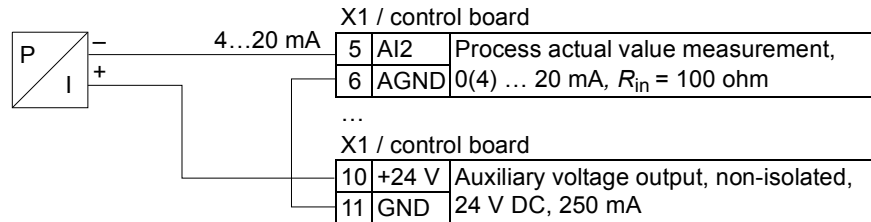

**Note:** The sensor is supplied through its current output and the drive feeds the supply voltage (+24 V). Thus the output signal must be 4...20 mA, not 0...20 mA

### Three-wire sensor/transmitter

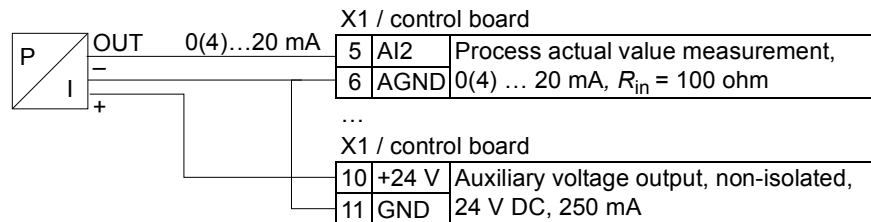

### Connection for obtaining 0...10 V from analog outputs

To obtain 0...10 V from analog outputs, connect a 500 ohm resistor (or two 1 kohm resistors in parallel) between the analog output and analog output circuit common AGND.

Examples for analog output 2 AO2 are shown in the figure below.

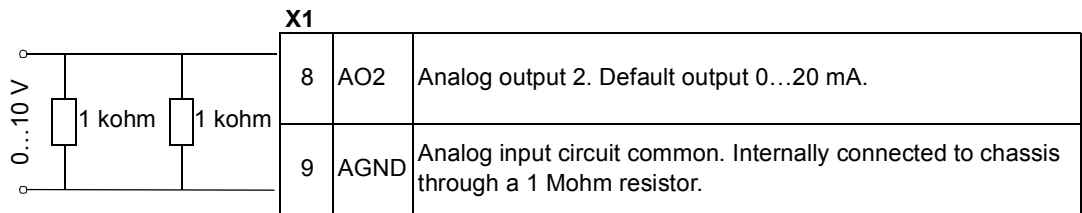
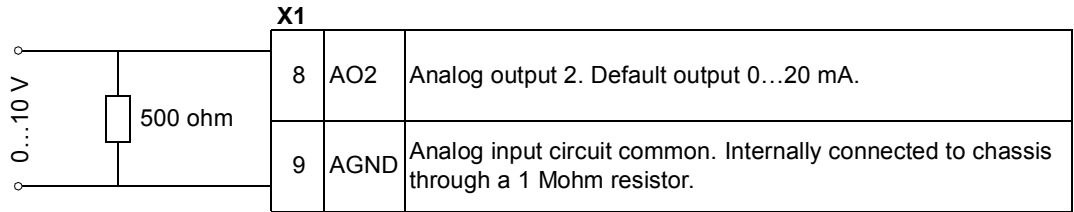



## User parameter sets



In addition to the standard application macros, it is possible to save two user parameter sets into the permanent memory and load them at a later time. A user parameter set consists of the user parameter settings, including [Group 99: START-UP DATA](#), and the results of the motor identification. The panel reference is also saved if the user parameter set is saved and loaded in local control. The remote control setting is saved into the user parameter set, but the local control setting is not.

The steps below show how to save and load User Parameter Set 1. The procedure for User Parameter Set 2 is identical, only the parameter [9902](#) values are different.

To save User Parameter Set 1:

- Adjust the parameters. Perform the motor identification if it is needed in the application but it is not done yet.
- Save the parameter settings and the results of the motor identification to the permanent memory by changing parameter [9902](#) to -1 (USER S1 SAVE).
- Press  (Assistant Control Panel) or  (Basic Control Panel).

To load User Parameter Set 1:

- Change parameter [9902](#) to 0 (USER S1 LOAD).
- Press  (Assistant Control Panel) or  (Basic Control Panel) to load.

The user parameter set can also be switched through digital inputs (see parameter [1605](#)).

**Note:** Loading the user parameter set restores the parameter settings including [Group 99: START-UP DATA](#) and the results of the motor identification. Check that the settings correspond to the motor used.

**Hint:** The user can for example switch the drive between two motors without having to adjust the motor parameters and to repeat the motor identification every time the motor is changed. The user needs only to adjust the settings and perform the motor identification once for each motor and then to save the data as two user parameter sets. When the motor is changed, only the corresponding user parameter set needs to be loaded, and the drive is ready to operate.



## Macro default values for parameters

Parameter default values are listed in section [Complete parameter list](#) on page 91. Changing from the default macro (ABB Standard), that is, editing the value of parameter 9902, changes the parameter default values as defined in the following tables.

**Note:** There are two sets of values because the defaults are configured for 50 Hz/ IEC compliance (ACS550-01) and 60 Hz/NEMA compliance (ACS550-U1).

### ACS550-01

Parameter	ABB Standard	3-wire	Alternate	Motor Potentiometer	Hand-auto	PID Control	PFC Control	Torque Control
9902	APPLIC MACRO 1 = ABB STANDARD	2 = 3-WIRE	3 = ALTERNATE	4 = MOTOR POT	5 = HAND/AUTO	6 = PID CONTROL	7 = PFC CONTROL	8 = TORQUE CTRL
9904	MOTOR CTRL MODE 3 = SCALAR: FREQ	1 = VECTOR: SPEED	1 = VECTOR: SPEED	1 = VECTOR: SPEED	1 = VECTOR: SPEED	1 = VECTOR: SPEED	3 = SCALAR: FREQ	2 = VECTOR: TORQUE
1001	EXT1 COMMANDS 2 = DI1,2	4 = DI1P,2P,3	9 = DI1F,2R	2 = DI1,2	2 = DI1,2	1 = DI1	1 = DI1	2 = DI1,2
1002	EXT2 COMMANDS 0 = NOT SEL	0 = NOT SEL	0 = NOT SEL	0 = NOT SEL	7 = DI6,5	6 = DI6	6 = DI6	2 = DI1,2
1003	DIRECTION 3 = REQUEST	3 = REQUEST	3 = REQUEST	3 = REQUEST	3 = REQUEST	1 = FORWARD	1 = FORWARD	3 = REQUEST
1102	EXT1/EXT2 SEL 0 = EXT1	0 = EXT1	0 = EXT1	0 = EXT1	3 = DI3	2 = DI2	3 = DI3	3 = DI3
1103	REF1 SELECT 1 = AI1	1 = AI1	1 = AI1	12 = DI3U,4D(NC)	1 = AI1	1 = AI1	1 = AI1	1 = AI1
1106	REF2 SELECT 2 = AI2	2 = AI2	2 = AI2	2 = AI2	2 = AI2	19 = PID1OUT	19 = PID1OUT	2 = AI2
1201	CONST SPEED SEL 9 = DI3,4	10 = DI4,5	9 = DI3,4	5 = DI5	0 = NOT SEL	9 = DI3,4	0 = NOT SEL	4 = DI4
1304	MINIMUM AI2 0.0%	0.0%	0.0%	0.0%	20.0%	20.0%	20.0%	20.0%
1401	RELAY OUTPUT 1 1 = READY	1 = READY	1 = READY	1 = READY	1 = READY	1 = READY	2 = RUN	1 = READY
1402	RELAY OUTPUT 2 2 = RUN	2 = RUN	2 = RUN	2 = RUN	2 = RUN	2 = RUN	3 = FAULT(-1)	2 = RUN
1403	RELAY OUTPUT 3 3 = FAULT(-1)	3 = FAULT(-1)	3 = FAULT(-1)	3 = FAULT(-1)	3 = FAULT(-1)	3 = FAULT(-1)	31 = PFC	3 = FAULT(-1)
1501	AO1 CONTENT SEL 103 = 0103 OUTPUT FREQ	102 = 0102 SPEED	102 = 0102 SPEED	102 = 0102 SPEED	102 = 0102 SPEED	102 = 0102 SPEED	103 = 0103 OUTPUT FREQ	102 = 0102 SPEED
1507	AO2 CONTENT SEL 104 = CURRENT	104 = CURRENT	104 = CURRENT	104 = CURRENT	104 = CURRENT	104 = CURRENT	130 = PID 1 FBK	104 = CURRENT
1510	MINIMUM AO2 0.0 mA	0.0 mA	0.0 mA	0.0 mA	0.0 mA	0.0 mA	4.0 mA	0.0 mA
1601	RUN ENABLE 0 = NOT SEL	0 = NOT SEL	6 = DI6	6 = DI6	4 = DI4	5 = DI5	2 = DI2	6 = DI6
2201	ACC/DEC 1/2 SEL 5 = DI5	0 = NOT SEL	5 = DI5	0 = NOT SEL	0 = NOT SEL	0 = NOT SEL	0 = NOT SEL	5 = DI5
3201	SUPERV 1 PARAM 103 = 0103 OUTPUT FREQ	102 = 0102 SPEED	102 = 0102 SPEED	102 = 0102 SPEED	102 = 0102 SPEED	102 = 0102 SPEED	103 = 0103 OUTPUT FREQ	102 = 0102 SPEED
3401	SIGNAL 1 PARAM 103 = 0103 OUTPUT FREQ	102 = 0102 SPEED	102 = 0102 SPEED	102 = 0102 SPEED	102 = 0102 SPEED	102 = 0102 SPEED	103 = 0103 OUTPUT FREQ	102 = 0102 SPEED
4001	GAIN 1.0	1.0	1.0	1.0	1.0	1.0	2.5	1.0
4002	INTEGRATION TIME 60.0 s	60.0 s	60.0 s	60.0 s	60.0 s	60.0 s	3.0 s	60.0 s
4101	GAIN 1.0	1.0	1.0	1.0	1.0	1.0	2.5	1.0
4102	INTEGRATION TIME 60.0 s	60.0 s	60.0 s	60.0 s	60.0 s	60.0 s	3.0 s	60.0 s
8123	PFC ENABLE 0 = NOT SEL	0 = NOT SEL	0 = NOT SEL	0 = NOT SEL	0 = NOT SEL	0 = NOT SEL	1 = ACTIVE	0 = NOT SEL

## ACS550-U1

Parameter	ABB Standard	3-wire	Alternate	Motor Potentiometer	Hand-auto	PID Control	PFC Control	Torque Control	
9902	APPLIC MACRO	1 = ABB STANDARD	2 = 3-WIRE	3 = ALTERNATE	4 = MOTOR POT	5 = HAND/AUTO	6 = PID CONTROL	7 = PFC CONTROL	8 = TORQUE CTRL
9904	MOTOR CTRL MODE	3 = SCALAR: FREQ	1 = VECTOR: SPEED	1 = VECTOR: SPEED	1 = VECTOR: SPEED	1 = VECTOR: SPEED	1 = VECTOR: SPEED	3 = SCALAR: FREQ	2 = VECTOR: TORQUE
1001	EXT1 COMMANDS	2 = DI1,2	4 = DI1P,2P,3	9 = DI1F,2R	2 = DI1,2	2 = DI1,2	1 = DI1	1 = DI1	2 = DI1,2
1002	EXT2 COMMANDS	0 = NOT SEL	0 = NOT SEL	0 = NOT SEL	0 = NOT SEL	7 = DI6,5	6 = DI6	6 = DI6	2 = DI1,2
1003	DIRECTION	3 = REQUEST	3 = REQUEST	3 = REQUEST	3 = REQUEST	3 = REQUEST	1 = FORWARD	1 = FORWARD	3 = REQUEST
1102	EXT1/EXT2 SEL	0 = EXT1	0 = EXT1	0 = EXT1	0 = EXT1	3 = DI3	2 = DI2	3 = DI3	3 = DI3
1103	REF1 SELECT	1 = AI1	1 = AI1	1 = AI1	12 = DI3U,4D(NC)	1 = AI1	1 = AI1	1 = AI1	1 = AI1
1106	REF2 SELECT	2 = AI2	2 = AI2	2 = AI2	2 = AI2	2 = AI2	19 = PID1OUT	19 = PID1OUT	2 = AI2
1201	CONST SPEED SEL	9 = DI3,4	10 = DI4,5	9 = DI3,4	5 = DI5	0 = NOT SEL	9 = DI3,4	0 = NOT SEL	4 = DI4
1304	MINIMUM AI2	0.0%	0.0%	0.0%	0.0%	20.0%	20.0%	20.0%	20.0%
1401	RELAY OUTPUT 1	1 = READY	1 = READY	1 = READY	1 = READY	1 = READY	1 = READY	2 = RUN	1 = READY
1402	RELAY OUTPUT 2	2 = RUN	2 = RUN	2 = RUN	2 = RUN	2 = RUN	2 = RUN	3 = FAULT(-1)	2 = RUN
1403	RELAY OUTPUT 3	3 = FAULT(-1)	3 = FAULT(-1)	3 = FAULT(-1)	3 = FAULT(-1)	3 = FAULT(-1)	3 = FAULT(-1)	31 = PFC	3 = FAULT(-1)
1501	AO1 CONTENT SEL	103 = 0103 OUTPUT FREQ	102 = 0102 SPEED	102 = 0102 SPEED	102 = 0102 SPEED	102 = 0102 SPEED	102 = 0102 SPEED	103 = 0103 OUTPUT FREQ	102 = 0102 SPEED
1507	AO2 CONTENT SEL	104 = CURRENT	104 = CURRENT	104 = CURRENT	104 = CURRENT	104 = CURRENT	104 = CURRENT	130 = PID 1 FBK	104 = CURRENT
1510	MINIMUM AO2	0.0 mA	0.0 mA	0.0 mA	0.0 mA	0.0 mA	0.0 mA	4.0 mA	0.0 mA
1601	RUN ENABLE	0 = NOT SEL	0 = NOT SEL	6 = DI6	6 = DI6	4 = DI4	5 = DI5	2 = DI2	6 = DI6
2201	ACC/DEC 1/2 SEL	5 = DI5	0 = NOT SEL	5 = DI5	0 = NOT SEL	0 = NOT SEL	0 = NOT SEL	0 = NOT SEL	5 = DI5
3201	SUPERV 1 PARAM	103 = 0103 OUTPUT FREQ	102 = 0102 SPEED	102 = 0102 SPEED	102 = 0102 SPEED	102 = 0102 SPEED	102 = 0102 SPEED	103 = 0103 OUTPUT FREQ	102 = 0102 SPEED
3401	SIGNAL1 PARAM	103 = 0103 OUTPUT FREQ	102 = 0102 SPEED	102 = 0102 SPEED	102 = 0102 SPEED	102 = 0102 SPEED	102 = 0102 SPEED	103 = 0103 OUTPUT FREQ	102 = 0102 SPEED
4001	GAIN	1.0	1.0	1.0	1.0	1.0	1.0	2.5	1.0
4002	INTEGRATION TIME	60.0 s	60.0 s	60.0 s	60.0 s	60.0 s	60.0 s	3.0 s	60.0 s
4101	GAIN	1.0	1.0	1.0	1.0	1.0	1.0	2.5	1.0
4102	INTEGRATION TIME	60.0 s	60.0 s	60.0 s	60.0 s	60.0 s	60.0 s	3.0 s	60.0 s
8123	PFC ENABLE	0 = NOT SEL	0 = NOT SEL	0 = NOT SEL	0 = NOT SEL	0 = NOT SEL	0 = NOT SEL	1 = ACTIVE	0 = NOT SEL

# Parameters

## Complete parameter list

The following table lists all parameters. Table header abbreviations are:

- S = Parameters can be modified only when the drive is stopped.
- User = Space to enter desired parameter values.

Some values depend on the “construction” as indicated in the table by  
 “-01:” = Setup and parts specific to IEC installation and compliance or  
 “-U1:” = Setup and parts specific to US installation and NEMA compliance.  
 Refer to the type designation on the drive, for example ACS550-01-08A8-4.

Code	Name	Range	Resolution	Default	User	S
<b>Group 99: START-UP DATA</b>						
9901	LANGUAGE	0...16 / 0...3	1	0 (ENGLISH)		
9902	APPLIC MACRO	-3...8, 31	1	1 (ABB STANDARD)		✓
9904	MOTOR CTRL MODE	1 = VECTOR:SPEED, 2 = VECTOR:TORQUE, 3 = SCALAR:FREQ	1	3 (SCALAR:FREQ)		✓
9905	MOTOR NOM VOLT	-01-yyyy-2: 115...345 V / -U1-yyyy-2: 115...345 V -01-yyyy-4: 200...600 V / -U1-yyyy-4: 230...690 V -U1-yyyy-6: 288...862 V	1 V	-01-yyyy-2: 230 V / -U1-yyyy-2: 230 V -01-yyyy-4 400 V / -U1-yyyy-4: 460 V -U1-yyyy-6: 575 V		✓
9906	MOTOR NOM CURR	$0.2 \cdot I_{2hd} \dots 2.0 \cdot I_{2hd}$	0.1 A	$1.0 \cdot I_{2hd}$		✓
9907	MOTOR NOM FREQ	10.0...500.0 Hz	0.1 Hz	-01: 50.0 Hz / -U1: 60.0 Hz		✓
9908	MOTOR NOM SPEED	50...30000 rpm	1 rpm	Size dependent		✓
9909	MOTOR NOM POWER	$0.2...3.0 \cdot P_{hd}$	-01: 0.1 kW / -U1: 0.1 hp	$1.0 \cdot P_{hd}$		✓
9910	ID RUN	0 = OFF/IDMAGN, 1 = ON	1	0 (OFF/IDMAGN)		✓
9915	MOTOR COSPHI	0 = IDENTIFIED, 0.01...0.97	0.01	0 (IDENTIFIED)		✓
<b>Group 01: OPERATING DATA</b>						
0101	SPEED & DIR	-30000...30000 rpm	1 rpm	-		
0102	SPEED	0...30000 rpm	1 rpm	-		
0103	OUTPUT FREQ	0.0...500.0 Hz	0.1 Hz	-		
0104	CURRENT	$0.0...2.0 \cdot I_{2hd}$	0.1 A	-		
0105	TORQUE	-200.0...200.0%	0.1%	-		
0106	POWER	$-2.0...2.0 \cdot P_{hd}$	0.1 kW	-		
0107	DC BUS VOLTAGE	$0...2.5 \cdot V_{dN}$	1 V	-		
0109	OUTPUT VOLTAGE	$0...2.0 \cdot V_{dN}$	1 V	-		
0110	DRIVE TEMP	0.0...150.0 °C	0.1 °C	-		
0111	EXTERNAL REF 1	0.0...500.0 Hz / 0...30000 rpm	0.1 Hz / 1 rpm	-		
0112	EXTERNAL REF 2	0.0...100.0% (0.0...600.0% for torque)	0.1%	-		
0113	CTRL LOCATION	0 = LOCAL, 1 = EXT1, 2 = EXT2	1	-		

Code	Name	Range	Resolution	Default	User	S
0114	RUN TIME (R)	0...9999 h	1 h	-		
0115	KWH COUNTER (R)	0...65535 kWh	1 kWh	-		
0116	APPL BLK OUTPUT	0.0...100.0% (0.0...600.0% for torque)	0.1%	-		
0118	DI 1-3 STATUS	000...111 (0...7 decimal)	1	-		
0119	DI 4-6 STATUS	000...111 (0...7 decimal)	1	-		
0120	AI 1	0.0...100.0%	0.1%	-		
0121	AI 2	0.0...100.0%	0.1%	-		
0122	RO 1-3 STATUS	000...111 (0...7 decimal)	1	-		
0123	RO 4-6 STATUS	000...111 (0...7 decimal)	1	-		
0124	AO 1	0.0...20.0 mA	0.1 mA	-		
0125	AO 2	0.0...20.0 mA	0.1 mA	-		
0126	PID 1 OUTPUT	-1000.0...1000.0%	0.1%	-		
0127	PID 2 OUTPUT	-100.0...100.0%	0.1%	-		
0128	PID 1 SETPNT	Unit and scale defined by par. 4006/ 4106 and 4007/4107	-	-		
0129	PID 2 SETPNT	Unit and scale defined by par. 4206 and 4207	-	-		
0130	PID 1 FBK	Unit and scale defined by par. 4006/ 4106 and 4007/4107	-	-		
0131	PID 2 FBK	Unit and scale defined by par. 4206 and 4207	-	-		
0132	PID 1 DEVIATION	Unit and scale defined by par. 4006/ 4106 and 4007/4107	-	-		
0133	PID 2 DEVIATION	Unit and scale defined by par. 4206 and 4207	-	-		
0134	COMM RO WORD	0...65535	1	-		
0135	COMM VALUE 1	-32768...+32767	1	-		
0136	COMM VALUE 2	-32768...+32767	1	-		
0137	PROCESS VAR 1	-	1			
0138	PROCESS VAR 2	-	1			
0139	PROCESS VAR 3	-	1			
0140	RUN TIME	0.00...499.99 kh	0.01 kh	-		
0141	MWH COUNTER	0...65535 MWh	1 MWh	-		
0142	REVOLUTION CNTR	0...65535 Mrev	1 Mrev	-		
0143	DRIVE ON TIME HI	0...65535 days	1 day	-		
0144	DRIVE ON TIME LO	00:00:00...23:59:58	1 = 2 s	-		
0145	MOTOR TEMP	Par. 3501 = 1...3: -10...200 °C Par. 3501 = 4: 0...5000 ohm Par. 3501 = 5...6: 0...1	1	-		
0146	MECH ANGLE	0...32768	1	-		
0147	MECH REVS	-32768 ...+32767	1	-		
0148	Z PLS DETECTED	0 = NOT DETECTED, 1 = DETECTED	1	-		
0150	CB TEMP	-20.0...150.0 °C	1.0 °C	-		
0153	MOT THERM STRESS	0.0...100.0%	0.1%	-		
0158	PID COMM VALUE 1	-32768 ...+32767	1	-		
0159	PID COMM VALUE 2	-32768 ...+32767	1	-		
0174	SAVED KWH	0.0...999.9 kWh	0.1 kWh	-		

Code	Name	Range	Resolution	Default	User	S
0175	SAVED MWH	0...65535 MWh	1 MWh	-		
0176	SAVED AMOUNT 1	0.0...999.9	0.1	-		
0177	SAVED AMOUNT 2	0...65535	1	-		
0178	SAVED CO2	0.0...6553.5 tn	0.1 tn	-		
<b>Group 03: FB ACTUAL SIGNALS</b>						
0301	FB CMD WORD 1	-	-	-		
0302	FB CMD WORD 2	-	-	-		
0303	FB STS WORD 1	-	-	-		
0304	FB STS WORD 2	-	1	-		
0305	FAULT WORD 1	-	1	-		
0306	FAULT WORD 2	-	1	-		
0307	FAULT WORD 3	-	1	-		
0308	ALARM WORD 1	-	1	-		
0309	ALARM WORD 2	-	1	-		
<b>Group 04: FAULT HISTORY</b>						
0401	LAST FAULT	Fault codes (panel displays as text)	1	0		
0402	FAULT TIME 1	Date dd.mm.yy / power-on time in days	1 day	0		
0403	FAULT TIME 2	Time hh.mm.ss	2 s	0		
0404	SPEED AT FLT	-32768...+32767	1 rpm	0		
0405	FREQ AT FLT	-3276.8...+3276.7	0.1 Hz	0		
0406	VOLTAGE AT FLT	0.0...6553.5	0.1 V	0		
0407	CURRENT AT FLT	0.0...6553.5	0.1 A	0		
0408	TORQUE AT FLT	-3276.8...+3276.7	0.1%	0		
0409	STATUS AT FLT	0000...FFFF hex	1	0		
0410	DI 1-3 AT FLT	000...111 (0...7 decimal)	1	0		
0411	DI 4-6 AT FLT	000...111 (0...7 decimal)	1	0		
0412	PREVIOUS FAULT 1	As par. 0401	1	0		
0413	PREVIOUS FAULT 2	As par. 0401	1	0		
<b>Group 10: START/STOP/DIR</b>						
1001	EXT1 COMMANDS	0...14	1	2 (DI1,2)		✓
1002	EXT2 COMMANDS	0...14	1	0 (NOT SEL)		✓
1003	DIRECTION	1 = FORWARD, 2 = REVERSE, 3 = REQUEST	1	3 (REQUEST)		✓
1004	JOGGING SEL	-6...6	1	0 (NOT SEL)		✓
<b>Group 11: REFERENCE SELECT</b>						
1101	KEYPAD REF SEL	1 = REF1(Hz/rpm), 2 = REF2(%)	1	1 [REF1(Hz/rpm)]		
1102	EXT1/EXT2 SEL	-6...12	1	0 (EXT1)		✓
1103	REF1 SELECT	0...17, 20...21	1	1 (AI1)		✓
1104	REF1 MIN	0.0...500.0 Hz / 0...30000 rpm	0.1 Hz / 1 rpm	0.0 Hz / 0 rpm		
1105	REF1 MAX	0.0...500.0 Hz / 0...30000 rpm	0.1 Hz / 1 rpm	-01: 50.0 (52.0) Hz / 1500 rpm -U1: 60.0 (62.0) Hz / 1800 rpm		
1106	REF2 SELECT	0...17, 19...21	1	2 (AI2)		✓
1107	REF2 MIN	0.0...100.0% (0.0...600.0% for torque)	0.1%	0.0%		
1108	REF2 MAX	0.0...100.0% (0.0...600.0% for torque)	0.1%	100.0%		

Code	Name	Range	Resolution	Default	User	S
<b>Group 12: CONSTANT SPEEDS</b>						
1201	CONST SPEED SEL	-14 ...19	1	9 (DI3,4)		✓
1202	CONST SPEED 1	0.0...500.0 Hz / 0...30000 rpm	0.1 Hz / 1 rpm	-01: 5.0 Hz / 300 rpm -U1: 6.0 Hz / 360 rpm		
1203	CONST SPEED 2	0.0...500.0 Hz / 0...30000 rpm	0.1 Hz / 1 rpm	-01: 10.0 Hz / 600 rpm -U1: 12.0 Hz / 720 rpm		
1204	CONST SPEED 3	0.0...500.0 Hz / 0...30000 rpm	0.1 Hz / 1 rpm	-01: 15.0 Hz / 900 rpm -U1: 18.0 Hz / 1080 rpm		
1205	CONST SPEED 4	0.0...500.0 Hz / 0...30000 rpm	0.1 Hz / 1 rpm	-01: 20.0 Hz / 1200 rpm -U1: 24.0 Hz / 1440 rpm		
1206	CONST SPEED 5	0.0...500.0 Hz / 0...30000 rpm	0.1 Hz / 1 rpm	-01: 25.0 Hz / 1500 rpm -U1: 30.0 Hz / 1800 rpm		
1207	CONST SPEED 6	0.0...500.0 Hz / 0...30000 rpm	0.1 Hz / 1 rpm	-01: 40.0 Hz / 2400 rpm -U1: 48.0 Hz / 2880 rpm		
1208	CONST SPEED 7	0.0...500.0 Hz / 0...30000 rpm	0.1 Hz / 1 rpm	-01: 50.0 Hz / 3000 rpm -U1: 60.0 Hz / 3600 rpm		
1209	TIMED MODE SEL	1 = EXT/CS1/2/3, 2 = CS1/2/3/4	1	2 (CS1/2/3/4)		✓
<b>Group 13: ANALOG INPUTS</b>						
1301	MINIMUM AI1	0.0...100.0%	0.1%	0.0%		
1302	MAXIMUM AI1	0.0...100.0%	0.1%	100.0%		
1303	FILTER AI1	0.0...10.0 s	0.1 s	0.1 s		
1304	MINIMUM AI2	0.0...100.0%	0.1%	0.0%		
1305	MAXIMUM AI2	0.0...100.0%	0.1%	100.0%		
1306	FILTER AI2	0.0...10.0 s	0.1 s	0.1 s		
<b>Group 14: RELAY OUTPUTS</b>						
1401	RELAY OUTPUT 1	0...44, 46, 47, 52	1	1 (READY)		
1402	RELAY OUTPUT 2	0...44, 46, 47, 52	1	2 (RUN)		
1403	RELAY OUTPUT 3	0...44, 46, 47, 52	1	3 [FAULT(-1)]		
1404	RO 1 ON DELAY	0.0...3600.0 s	0.1 s	0.0 s		
1405	RO 1 OFF DELAY	0.0...3600.0 s	0.1 s	0.0 s		
1406	RO 2 ON DELAY	0.0...3600.0 s	0.1 s	0.0 s		
1407	RO 2 OFF DELAY	0.0...3600.0 s	0.1 s	0.0 s		
1408	RO 3 ON DELAY	0.0...3600.0 s	0.1 s	0.0 s		
1409	RO 3 OFF DELAY	0.0...3600.0 s	0.1 s	0.0 s		
1410	RELAY OUTPUT 4	0...44, 46, 47, 52	1	0 (NOT SEL)		
1411	RELAY OUTPUT 5	0...44, 46, 47, 52	1	0 (NOT SEL)		
1412	RELAY OUTPUT 6	0...44, 46, 47, 52	1	0 (NOT SEL)		
1413	RO 4 ON DELAY	0.0...3600.0 s	0.1 s	0.0 s		
1414	RO 4 OFF DELAY	0.0...3600.0 s	0.1 s	0.0 s		
1415	RO 5 ON DELAY	0.0...3600.0 s	0.1 s	0.0 s		
1416	RO 5 OFF DELAY	0.0...3600.0 s	0.1 s	0.0 s		
1417	RO 6 ON DELAY	0.0...3600.0 s	0.1 s	0.0 s		
1418	RO 6 OFF DELAY	0.0...3600.0 s	0.1 s	0.0 s		
<b>Group 15: ANALOG OUTPUTS</b>						
1501	AO1 CONTENT SEL	99...178	1	103 (parameter 0103 OUTPUT FREQ)		

Code	Name	Range	Resolution	Default	User	S
1502	AO1 CONTENT MIN	-	-	Depends on the signal selected with par. 1501		
1503	AO1 CONTENT MAX	-	-	Depends on the signal selected with par. 1501		
1504	MINIMUM AO1	0.0...20.0 mA	0.1 mA	0.0 mA		
1505	MAXIMUM AO1	0.0...20.0 mA	0.1 mA	20.0 mA		
1506	FILTER AO1	0.0...10.0 s	0.1 s	0.1 s		
1507	AO2 CONTENT SEL	99...178	1	104 (parameter 0104 CURRENT)		
1508	AO2 CONTENT MIN	-	-	Depends on the signal selected with par. 1507		
1509	AO2 CONTENT MAX	-	-	Depends on the signal selected with par. 1507		
1510	MINIMUM AO2	0.0...20.0 mA	0.1 mA	0.0 mA		
1511	MAXIMUM AO2	0.0...20.0 mA	0.1 mA	20.0 mA		
1512	FILTER AO2	0.0...10.0 s	0.1 s	0.1 s		
<b>Group 16: SYSTEM CONTROLS</b>						
1601	RUN ENABLE	-6...7	1	0 (NOT SEL)		✓
1602	PARAMETER LOCK	0 = LOCKED, 1 = OPEN, 2 = NOT SAVED	1	1 (OPEN)		
1603	PASS CODE	0...65535	1	0		
1604	FAULT RESET SEL	-6...8	1	0 (KEYPAD)		
1605	USER PAR SET CHG	-6...6	1	0 (NOT SEL)		
1606	LOCAL LOCK	-6...8	1	0 (NOT SEL)		
1607	PARAM SAVE	0 = DONE, 1 = SAVE...	1	0 (DONE)		
1608	START ENABLE 1	-6...7	1	0 (NOT SEL)		✓
1609	START ENABLE 2	-6...7	1	0 (NOT SEL)		✓
1610	DISPLAY ALARMS	0 = NO, 1 = YES	1	0 (NO)		
1611	PARAMETER VIEW	0 = DEFAULT, 1 = FLASHDROP	1	0 (DEFAULT)		
1612	FAN CONTROL	0 = AUTO, 1 = ON	1	0 (AUTO)		
1613	FAULT RESET	0 = DEFAULT, 1 = RESET NOW	1	0 (DEFAULT)		
<b>Group 20: LIMITS</b>						
2001	MINIMUM SPEED	-30000...30000 rpm	1 rpm	0 rpm		✓
2002	MAXIMUM SPEED	0...30000 rpm	1 rpm	-01: 1500 rpm / -U1: 1800 rpm		✓
2003	MAX CURRENT	0... $1.8 \cdot I_{2hd}$	0.1 A	$1.8 \cdot I_{2hd}$		✓
2005	OVERVOLT CTRL	0 = DISABLE, 1 = ENABLE	1	1 (ENABLE)		
2006	UNDERVOLT CTRL	0 = DISABLE, 1 = ENABLE(TIME), 2 = ENABLE	1	1 [ENABLE(TIME)]		
2007	MINIMUM FREQ	-500.0...500.0 Hz	0.1 Hz	0.0 Hz		✓
2008	MAXIMUM FREQ	0.0...500.0 Hz	0.1 Hz	-01: 50.0 (52.0) Hz / -U1: 60.0 (62.0) Hz		✓
2013	MIN TORQUE SEL	-6...7	1	0 (MIN TORQUE 1)		
2014	MAX TORQUE SEL	-6...7	1	0 (MAX TORQUE 1)		
2015	MIN TORQUE 1	-600.0...0.0%	0.1%	-300.0%		
2016	MIN TORQUE 2	-600.0...0.0%	0.1%	-300.0%		
2017	MAX TORQUE 1	0.0...600.0%	0.1%	300.0%		
2018	MAX TORQUE 2	0.0...600.0%	0.1%	300.0%		

Code	Name	Range	Resolution	Default	User	S
<b>Group 21: START/STOP</b>						
2101	START FUNCTION	Vector control modes: 1, 2, 8 Scalar control mode: 1...5, 8	1	8 (RAMP)		✓
2102	STOP FUNCTION	1 = COAST, 2 = RAMP	1	1 (COAST)		
2103	DC MAGN TIME	0.00...10.00 s	0.01 s	0.30 s		
2104	DC HOLD CTL	0 = NOT SEL, 1 = DC HOLD, 2 = DC BRAKING	1	0 (NOT SEL)		✓
2105	DC HOLD SPEED	0...360 rpm	1 rpm	5 rpm		
2106	DC CURR REF	0...100%	1%	30%		
2107	DC BRAKE TIME	0.0...250.0 s	0.1 s	0.0 s		
2108	START INHIBIT	0 = OFF, 1 = ON	1	0 (OFF)		
2109	EMERG STOP SEL	-6...6	1	0 (NOT SEL)		
2110	TORQ BOOST CURR	15...300%	1%	100%		
2112	ZERO SPEED DELAY	0.0 = NOT SEL, 0.1...60.0 s	0.1 s	0.0 s (NOT SEL)		
2113	START DELAY	0.00...60.00 s	0.01 s	0.00 s		
<b>Group 22: ACCEL/DECEL</b>						
2201	ACC/DEC 1/2 SEL	-6...7	1	5 (DI5)		
2202	ACCELER TIME 1	0.0...1800.0 s	0.1 s	5.0 s		
2203	DECELER TIME 1	0.0...1800.0 s	0.1 s	5.0 s		
2204	RAMP SHAPE 1	0.0 = LINEAR, 0.1...1000.0 s	0.1 s	0.0 s		
2205	ACCELER TIME 2	0.0...1800.0 s	0.1 s	60.0 s		
2206	DECELER TIME 2	0.0...1800.0 s	0.1 s	60.0 s		
2207	RAMP SHAPE 2	0.0 = LINEAR, 0.1...1000.0 s	0.1 s	0.0 s		
2208	EMERG DEC TIME	0.0...1800.0 s	0.1 s	1.0 s		
2209	RAMP INPUT 0	-6...7	1	0 (NOT SEL)		
<b>Group 23: SPEED CONTROL</b>						
2301	PROP GAIN	0.00...200.00	0.01	5.00		
2302	INTEGRATION TIME	0.00...600.00 s	0.01 s	0.50 s		
2303	DERIVATION TIME	0...10000 ms	1 ms	0 ms		
2304	ACC COMPENSATION	0.00...600.00 s	0.01 s	0.00 s		
2305	AUTOTUNE RUN	0 = OFF, 1 = ON	1	0 (OFF)		
<b>Group 24: TORQUE CONTROL</b>						
2401	TORQ RAMP UP	0.00...120.00 s	0.01 s	0.00 s		
2402	TORQ RAMP DOWN	0.00...120.00 s	0.01 s	0.00 s		
<b>Group 25: CRITICAL SPEEDS</b>						
2501	CRIT SPEED SEL	0 = OFF, 1 = ON	1	0 (OFF)		
2502	CRIT SPEED 1 LO	0.0...500.0 Hz / 0...30000 rpm	0.1 Hz / 1 rpm	0.0 Hz / 0 rpm		
2503	CRIT SPEED 1 HI	0.0...500.0 Hz / 0...30000 rpm	0.1 Hz / 1 rpm	0.0 Hz / 0 rpm		
2504	CRIT SPEED 2 LO	0.0...500.0 Hz / 0...30000 rpm	0.1 Hz / 1 rpm	0.0 Hz / 0 rpm		
2505	CRIT SPEED 2 HI	0.0...500.0 Hz / 0...30000 rpm	0.1 Hz / 1 rpm	0.0 Hz / 0 rpm		
2506	CRIT SPEED 3 LO	0.0...500.0 Hz / 0...30000 rpm	0.1 Hz / 1 rpm	0.0 Hz / 0 rpm		
2507	CRIT SPEED 3 HI	0.0...500.0 Hz / 0...30000 rpm	0.1 Hz / 1 rpm	0.0 Hz / 0 rpm		
<b>Group 26: MOTOR CONTROL</b>						
2601	FLUX OPT ENABLE	0 = OFF, 1 = ON	1	0 (OFF)		
2602	FLUX BRAKING	0 = OFF, 1 = ON	1	0 (OFF)		



Code	Name	Range	Resolution	Default	User	S
2603	IR COMP VOLT	0.0...100.0 V	0.1 V	Size dependent		
2604	IR COMP FREQ	0...100%	1%	80%		
2605	U/F RATIO	1 = LINEAR, 2 = SQUARED	1	1 (LINEAR)		
2606	SWITCHING FREQ	1, 2, 4, 8, 12 kHz	-	4 kHz		
2607	SWITCH FREQ CTRL	0 = OFF, 1 = ON	1	1 (ON)		
2608	SLIP COMP RATIO	0...200%	1%	0%		
2609	NOISE SMOOTHING	0 = DISABLE, 1 = ENABLE	1	0 (DISABLE)		
2619	DC STABILIZER	0 = DISABLE, 1 = ENABLE	1	0 (DISABLE)		
2625	OVERMODULATION	0 = DISABLE, 1 = ENABLE	1	0 (DISABLE)		
<b>Group 29: MAINTENANCE TRIG</b>						
2901	COOLING FAN TRIG	0.0...6553.5 kh, 0.0 disables	0.1 kh	0.0 kh		
2902	COOLING FAN ACT	0.0...6553.5 kh	0.1 kh	0.0 kh		
2903	REVOLUTION TRIG	0...65535 Mrev, 0 disables	1 Mrev	0 Mrev		
2904	REVOLUTION ACT	0...65535 Mrev	1 Mrev	0 Mrev		
2905	RUN TIME TRIG	0.0...6553.5 kh, 0.0 disables	0.1 kh	0.0 kh		
2906	RUN TIME ACT	0.0...6553.5 kh	0.1 kh	0.0 kh		
2907	USER MWh TRIG	0.0...6553.5 MWh, 0.0 disables	0.1 MWh	0.0 MWh		
2908	USER MWh ACT	0.0...6553.5 MWh	0.1 MWh	0.0 MWh		
<b>Group 30: FAULT FUNCTIONS</b>						
3001	AI<MIN FUNCTION	0...3	1	0 (NOT SEL)		
3002	PANEL COMM ERR	1...3	1	1 (FAULT)		
3003	EXTERNAL FAULT 1	-6...6	1	0 (NOT SEL)		
3004	EXTERNAL FAULT 2	-6...6	1	0 (NOT SEL)		
3005	MOT THERM PROT	0 = NOT SEL, 1 = FAULT, 2 = ALARM	1	1 (FAULT)		
3006	MOT THERM TIME	256...9999 s	1 s	500 s		
3007	MOT LOAD CURVE	50...150%	1%	100%		
3008	ZERO SPEED LOAD	25...150%	1%	70%		
3009	BREAK POINT FREQ	1...250 Hz	1 Hz	35 Hz		
3010	STALL FUNCTION	0 = NOT SEL, 1 = FAULT, 2 = ALARM	1	0 (NOT SEL)		
3011	STALL FREQUENCY	0.5...50.0 Hz	0.1 Hz	20.0 Hz		
3012	STALL TIME	10...400 s	1 s	20 s		
3017	EARTH FAULT	0 = DISABLE, 1 = ENABLE	1	1 (ENABLE)		✓
3018	COMM FAULT FUNC	0 = NOT SEL, 1 = FAULT, 2 = CONST SP 7, 3 = LAST SPEED	1	0 (NOT SEL)		
3019	COMM FAULT TIME	0.0...600.0 s	0.1 s	3.0 s		
3021	AI1 FAULT LIMIT	0.0...100.0%	0.1%	0.0%		
3022	AI2 FAULT LIMIT	0.0...100.0%	0.1%	0.0%		
3023	WIRING FAULT	0 = DISABLE, 1 = ENABLE	1	1 (ENABLE)		✓
3024	CB TEMP FAULT	0 = DISABLE, 1 = ENABLE	1	1 (ENABLE)		
3028	EARTH FAULT LVL	1...3	1	-01: 2 (MEDIUM) -U1: 1 (LOW)		
<b>Group 31: AUTOMATIC RESET</b>						
3101	NUMBER OF TRIALS	0...5	1	0		
3102	TRIAL TIME	1.0...600.0 s	0.1 s	30.0 s		
3103	DELAY TIME	0.0...120.0 s	0.1 s	0.0 s		

Code	Name	Range	Resolution	Default	User	S
3104	AR OVERCURRENT	0 = DISABLE, 1 = ENABLE	1	0 (DISABLE)		
3105	AR OVERVOLTAGE	0 = DISABLE, 1 = ENABLE	1	0 (DISABLE)		
3106	AR UNDERVOLTAGE	0 = DISABLE, 1 = ENABLE	1	0 (DISABLE)		
3107	AR AI<MIN	0 = DISABLE, 1 = ENABLE	1	0 (DISABLE)		
3108	AR EXTERNAL FLT	0 = DISABLE, 1 = ENABLE	1	0 (DISABLE)		
<b>Group 32: SUPERVISION</b>						
3201	SUPERV 1 PARAM	100 = NOT SELECTED, 101...178	1	103 (parameter 0103 OUTPUT FREQ)		
3202	SUPERV 1 LIM LO	-	-	Depends on the signal selected with par. 3201		
3203	SUPERV 1 LIM HI	-	-	Depends on the signal selected with par. 3201		
3204	SUPERV 2 PARAM	100 = NOT SELECTED, 101...178	1	104 (parameter 0104 CURRENT)		
3205	SUPERV 2 LIM LO	-	-	Depends on the signal selected with par. 3204		
3206	SUPERV 2 LIM HI	-	-	Depends on the signal selected with par. 3204		
3207	SUPERV 3 PARAM	100 = NOT SELECTED, 101...178	1	105 (parameter 0105 TORQUE)		
3208	SUPERV 3 LIM LO	-	-	Depends on the signal selected with par. 3207		
3209	SUPERV 3 LIM HI	-	-	Depends on the signal selected with par. 3207		
<b>Group 33: INFORMATION</b>						
3301	FIRMWARE	0000...FFFF hex	1	Firmware version		
3302	LOADING PACKAGE	0000...FFFF hex	1	Type dependent		
3303	TEST DATE	yy.ww	0.01	-		
3304	DRIVE RATING	-	-	Type dependent		
3305	PARAMETER TABLE	0000...FFFF hex	1	Type dependent		
<b>Group 34: PANEL DISPLAY</b>						
3401	SIGNAL1 PARAM	100 = NOT SELECTED, 101...178	1	103 (parameter 0103 OUTPUT FREQ)		
3402	SIGNAL1 MIN	-	-	Depends on the signal selected with par. 3401		
3403	SIGNAL1 MAX	-	-	Depends on the signal selected with par. 3401		
3404	OUTPUT1 DSP FORM	0...9	1	9 (DIRECT)		
3405	OUTPUT1 UNIT	0...127	1	Depends on the signal selected with par. 3401		
3406	OUTPUT1 MIN	-	-	Depends on the signal selected with par. 3401		
3407	OUTPUT1 MAX	-	-	Depends on the signal selected with par. 3401		
3408	SIGNAL2 PARAM	100 = NOT SELECTED, 101...178	1	104 (parameter 0104 CURRENT)		
3409	SIGNAL2 MIN	-	-	Depends on the signal selected with par. 3408		
3410	SIGNAL2 MAX	-	-	Depends on the signal selected with par. 3408		

Code	Name	Range	Resolution	Default	User	S
3411	OUTPUT2 DSP FORM	0...9	1	9 (DIRECT)		
3412	OUTPUT2 UNIT	0...127	1	Depends on the signal selected with par. 3408		
3413	OUTPUT2 MIN	-	-	Depends on the signal selected with par. 3408		
3414	OUTPUT2 MAX	-	-	Depends on the signal selected with par. 3408		
3415	SIGNAL3 PARAM	100 = NOT SELECTED, 101...178	1	105 (parameter 0105 TORQUE)		
3416	SIGNAL3 MIN	-	-	Depends on the signal selected with par. 3415		
3417	SIGNAL3 MAX	-	-	Depends on the signal selected with par. 3415		
3418	OUTPUT3 DSP FORM	0...9	1	9 (DIRECT)		
3419	OUTPUT3 UNIT	0...127	1	Depends on the signal selected with par. 3415		
3420	OUTPUT3 MIN	-	-	Depends on the signal selected with par. 3415		
3421	OUTPUT3 MAX	-	-	Depends on the signal selected with par. 3415		
<b>Group 35: MOTOR TEMP MEAS</b>						
3501	SENSOR TYPE	0...6	1	0 (NONE)		
3502	INPUT SELECTION	1...8	1	1 (AI1)		
3503	ALARM LIMIT	Par. 3501 = 1...3: -10...200 °C Par. 3501 = 4: 0...5000 ohm Par. 3501 = 5...6: 0...1	1	110 °C / 1500 ohm / 0		
3504	FAULT LIMIT	Par. 3501 = 1...3: -10...200 °C Par. 3501 = 4: 0...5000 ohm Par. 3501 = 5...6: 0...1	1	130 °C / 4000 ohm / 0		
<b>Group 36: TIMED FUNCTIONS</b>						
3601	TIMERS ENABLE	-6...7	1	0 (NOT SEL)		
3602	START TIME 1	00:00:00...23:59:58	2 s	00:00:00		
3603	STOP TIME 1	00:00:00...23:59:58	2 s	00:00:00		
3604	START DAY 1	1...7	1	1 (MONDAY)		
3605	STOP DAY 1	1...7	1	1 (MONDAY)		
3606	START TIME 2	00:00:00...23:59:58	2 s	00:00:00		
3607	STOP TIME 2	00:00:00...23:59:58	2 s	00:00:00		
3608	START DAY 2	1...7	1	1 (MONDAY)		
3609	STOP DAY 2	1...7	1	1 (MONDAY)		
3610	START TIME 3	00:00:00...23:59:58	2 s	00:00:00		
3611	STOP TIME 3	00:00:00...23:59:58	2 s	00:00:00		
3612	START DAY 3	1...7	1	1 (MONDAY)		
3613	STOP DAY 3	1...7	1	1 (MONDAY)		
3614	START TIME 4	00:00:00...23:59:58	2 s	00:00:00		
3615	STOP TIME 4	00:00:00...23:59:58	2 s	00:00:00		
3616	START DAY 4	1...7	1	1 (MONDAY)		
3617	STOP DAY 4	1...7	1	1 (MONDAY)		
3622	BOOSTER SEL	-6...6	1	0 (NOT SEL)		
3623	BOOSTER TIME	00:00:00...23:59:58	2 s	00:00:00		

Code	Name	Range	Resolution	Default	User	S
3626	TIMED FUNC 1...4 SRC	0...31	1	0 (NOT SEL)		
...						
3629						
<b>Group 37: USER LOAD CURVE</b>						
3701	USER LOAD C MODE	0...3	1	0 (NOT SEL)		
3702	USER LOAD C FUNC	1 = FAULT, 2 = ALARM	1	1 (FAULT)		
3703	USER LOAD C TIME	10...400 s	1 s	20 s		
3704	LOAD FREQ 1	0...500 Hz	1 Hz	5 Hz		
3705	LOAD TORQ LOW 1	0...600%	1%	10%		
3706	LOAD TORQ HIGH 1	0...600%	1%	300%		
3707	LOAD FREQ 2	0...500 Hz	1 Hz	25 Hz		
3708	LOAD TORQ LOW 2	0...600%	1%	15%		
3709	LOAD TORQ HIGH 2	0...600%	1%	300%		
3710	LOAD FREQ 3	0...500 Hz	1 Hz	43 Hz		
3711	LOAD TORQ LOW 3	0...600%	1%	25%		
3712	LOAD TORQ HIGH 3	0...600%	1%	300%		
3713	LOAD FREQ 4	0...500 Hz	1 Hz	50 Hz		
3714	LOAD TORQ LOW 4	0...600%	1%	30%		
3715	LOAD TORQ HIGH 4	0...600%	1%	300%		
3716	LOAD FREQ 5	0...500 Hz	1 Hz	500 Hz		
3717	LOAD TORQ LOW 5	0...600%	1%	30%		
3718	LOAD TORQ HIGH 5	0...600%	1%	300%		
<b>Group 40: PROCESS PID SET 1</b>						
4001	GAIN	0.1...100.0	0.1	1.0		
4002	INTEGRATION TIME	0.0 = NOT SEL, 0.1...3600.0 s	0.1 s	60.0 s		
4003	DERIVATION TIME	0.0...10.0 s	0.1 s	0.0 s		
4004	PID DERIV FILTER	0.0...10.0 s	0.1 s	1.0 s		
4005	ERROR VALUE INV	0 = NO, 1 = YES	1	0 (NO)		
4006	UNITS	0...127	1	4 (%)		
4007	UNIT SCALE	0...4	1	1		
4008	0% VALUE	Unit and scale defined by par. 4006 and 4007	-	0.0		
4009	100% VALUE	Unit and scale defined by par. 4006 and 4007	-	100.0		
4010	SET POINT SEL	0...2, 8...17, 19...20	1	1 (AI1)		✓
4011	INTERNAL SETPNT	Unit and scale defined by par. 4006 and 4007	-	40.0		
4012	SETPOINT MIN	-500.0...500.0%	0.1%	0.0%		
4013	SETPOINT MAX	-500.0...500.0%	0.1%	100.0%		
4014	FBK SEL	1...13	1	1 (ACT1)		
4015	FBK MULTIPLIER	0.000 = NOT SEL, -32.768...32.767	0.001	0.000 (NOT SEL)		
4016	ACT1 INPUT	1...7	1	2 (AI2)		✓
4017	ACT2 INPUT	1...7	1	2 (AI2)		✓
4018	ACT1 MINIMUM	-1000...1000%	1%	0%		
4019	ACT1 MAXIMUM	-1000...1000%	1%	100%		
4020	ACT2 MINIMUM	-1000...1000%	1%	0%		

Code	Name	Range	Resolution	Default	User	S
4021	ACT2 MAXIMUM	-1000...1000%	1%	100%		
4022	SLEEP SELECTION	-6...7	1	0 (NOT SEL)		
4023	PID SLEEP LEVEL	0.0...500.0 Hz / 0...30000 rpm	0.1 Hz / 1 rpm	0.0 Hz / 0 rpm		
4024	PID SLEEP DELAY	0.0...3600.0 s	0.1 s	60.0 s		
4025	WAKE-UP DEV	Unit and scale defined by par. 4006 and 4007	-	0.0		
4026	WAKE-UP DELAY	0.00...60.00 s	0.01 s	0.50 s		
4027	PID 1 PARAM SET	-6...14	1	0 (SET 1)		
<b>Group 41: PROCESS PID SET 2</b>						
4101	GAIN	0.1...100.0	0.1	1.0		
4102	INTEGRATION TIME	0.0 = NOT SEL, 0.1...3600.0 s	0.1 s	60.0 s		
4103	DERIVATION TIME	0.0...10.0 s	0.1 s	0.0 s		
4104	PID DERIV FILTER	0.0...10.0 s	0.1 s	1.0 s		
4105	ERROR VALUE INV	0 = NO, 1 = YES	1	0 (NO)		
4106	UNITS	0...127	1	4 (%)		
4107	UNIT SCALE	0...4	1	1		
4108	0% VALUE	Unit and scale defined by par. 4106 and 4107	-	0.0		
4109	100% VALUE	Unit and scale defined by par. 4106 and 4107	-	100.0		
4110	SET POINT SEL	0...2, 8...17, 19...20	1	1 (AI1)		✓
4111	INTERNAL SETPNT	Unit and scale defined by par. 4106 and 4107	-	40.0		
4112	SETPOINT MIN	-500.0...500.0%	0.1%	0.0%		
4113	SETPOINT MAX	-500.0...500.0%	0.1%	100.0%		
4114	FBK SEL	1...13	1	1 (ACT1)		
4115	FBK MULTIPLIER	0.000 = NOT SEL, -32.768...32.767	0.001	0.000 (NOT SEL)		
4116	ACT1 INPUT	1...7	1	2 (AI2)		✓
4117	ACT2 INPUT	1...7	1	2 (AI2)		✓
4118	ACT1 MINIMUM	-1000...1000%	1%	0%		
4119	ACT1 MAXIMUM	-1000...1000%	1%	100%		
4120	ACT2 MINIMUM	-1000...1000%	1%	0%		
4121	ACT2 MAXIMUM	-1000...1000%	1%	100%		
4122	SLEEP SELECTION	-6...7	1	0 (NOT SEL)		
4123	PID SLEEP LEVEL	0.0...500.0 Hz / 0...30000 rpm	0.1 Hz / 1 rpm	0.0 Hz / 0 rpm		
4124	PID SLEEP DELAY	0.0...3600.0 s	0.1 s	60.0 s		
4125	WAKE-UP DEV	Unit and scale defined by par. 4106 and 4107	-	0.0		
4126	WAKE-UP DELAY	0.00...60.00 s	0.01 s	0.50 s		
<b>Group 42: EXT / TRIM PID</b>						
4201	GAIN	0.1...100.0	0.1	1.0		
4202	INTEGRATION TIME	0.0 = NOT SEL, 0.1...3600.0 s	0.1 s	60.0 s		
4203	DERIVATION TIME	0.0...10.0 s	0.1 s	0.0 s		
4204	PID DERIV FILTER	0.0...10.0 s	0.1 s	1.0 s		
4205	ERROR VALUE INV	0 = NO, 1 = YES	1	0 (NO)		
4206	UNITS	0...127	1	4 (%)		

Code	Name	Range	Resolution	Default	User	S
4207	UNIT SCALE	0...4	1	1		
4208	0% VALUE	Unit and scale defined by par. 4206 and 4207	-	0.0		
4209	100% VALUE	Unit and scale defined by par. 4206 and 4207	-	100.0		
4210	SET POINT SEL	0...2, 8...17, 19...20	1	1 (AI1)		✓
4211	INTERNAL SETPNT	Unit and scale defined by par. 4206 and 4207	-	40.0		
4212	SETPOINT MIN	-500.0...500.0%	0.1%	0.0%		
4213	SETPOINT MAX	-500.0...500.0%	0.1%	100.0%		
4214	FBK SEL	1...13	1	1 (ACT1)		
4215	FBK MULTIPLIER	0.000 = NOT SEL, -32.768...32.767	0.001	0.000 (NOT SEL)		
4216	ACT1 INPUT	1...7	1	2 (AI2)		✓
4217	ACT2 INPUT	1...7	1	2 (AI2)		✓
4218	ACT1 MINIMUM	-1000...1000%	1%	0%		
4219	ACT1 MAXIMUM	-1000...1000%	1%	100%		
4220	ACT2 MINIMUM	-1000...1000%	1%	0%		
4221	ACT2 MAXIMUM	-1000...1000%	1%	100%		
4228	ACTIVATE	-6...12	1	0 (NOT SEL)		
4229	OFFSET	0.0...100.0%	0.1%	0.0%		
4230	TRIM MODE	0 = NOT SEL, 1 = PROPORTIONAL, 3 = DIRECT	1	0 (NOT SEL)		
4231	TRIM SCALE	-100.0...100.0%	0.1%	0.0%		
4232	CORRECTION SRC	1 = PID2REF, 2 = PID2OUTPUT	1	1 (PID2REF)		
<b>Group 45: ENERGY SAVING</b>						
4502	ENERGY PRICE	0.00...655.35	0.01	0.00		
4507	CO2 CONV FACTOR	0.0...10.0 tn/MWh	0.1 tn/MWh	0.5 tn/MWh		
4508	PUMP POWER	0.0...1000.0%	0.1%	100.0%		
4509	ENERGY RESET	0 = DONE, 1 = RESET	1	0 (DONE)		
<b>Group 50: ENCODER</b>						
5001	PULSE NR	50...16384	1	1024		✓
5002	ENCODER ENABLE	0 = DISABLE, 1 = ENABLE	1	0 (DISABLE)		✓
5003	ENCODER FAULT	1 = FAULT, 2 = ALARM	1	1 (FAULT)		✓
5010	Z PLS ENABLE	0 = DISABLE, 1 = ENABLE	1	0 (DISABLE)		✓
5011	POSITION RESET	0 = DISABLE, 1 = ENABLE	1	0 (DISABLE)		
<b>Group 51: EXT COMM MODULE</b>						
5101	FBA TYPE	-	-	0 (NOT DEFINED)		
5102... 5126	FB PAR 2...26	0...65535	1	0		
5127	FBA PAR REFRESH	0 = DONE, 1 = REFRESH	1	0 (DONE)		✓
5128	FILE CPI FW REV	0000...FFFF hex	1	0		
5129	FILE CONFIG ID	0000...FFFF hex	1	0		
5130	FILE CONFIG REV	0000...FFFF hex	1	0		
5131	FBA STATUS	0...6	1	0 (IDLE)		
5132	FBA CPI FW REV	0000...FFFF hex	1	0		
5133	FBA APPL FW REV	0000...FFFF hex	1	0		

Code	Name	Range	Resolution	Default	User	S
<b>Group 52: PANEL COMM</b>						
5201	STATION ID	1...247	1	1		
5202	BAUD RATE	9.6, 19.2, 38.4, 57.6, 115.2 kbits/s	-	9.6 kbits/s		
5203	PARITY	0 = 8 NONE 1, 1 = 8 NONE 2, 2 = 8 EVEN 1, 3 = 8 ODD 1	1	0 (8 NONE 1)		
5204	OK MESSAGES	0...65535	1	-		
5205	PARITY ERRORS	0...65535	1	-		
5206	FRAME ERRORS	0...65535	1	-		
5207	BUFFER OVERRUNS	0...65535	1	-		
5208	CRC ERRORS	0...65535	1	-		
<b>Group 53: EFB PROTOCOL</b>						
5301	EFB PROTOCOL ID	0...0xFFFF	1	0		
5302	EFB STATION ID	0...65535	1	1		✓
5303	EFB BAUD RATE	1.2, 2.4, 4.8, 9.6, 19.2, 38.4, 57.6, 76.8 kbits/s	-	9.6 kbits/s		
5304	EFB PARITY	0 = 8 NONE 1, 1 = 8 NONE 2, 2 = 8 EVEN 1, 3 = 8 ODD 1		0 (8 NONE 1)		
5305	EFB CTRL PROFILE	0 = ABB DRV LIM, 1 = DCU PROFILE, 2 = ABB DRV FULL	1	0 (ABB DRV LIM)		
5306	EFB OK MESSAGES	0...65535	1	0		
5307	EFB CRC ERRORS	0...65535	1	0		
5308	EFB UART ERRORS	0...65535	1	0		
5309	EFB STATUS	0...7	1	0 (IDLE)		
5310	EFB PAR 10	0...65535	1	0		
5311	EFB PAR 11	0...65535	1	0		
5312	EFB PAR 12	0...65535	1	0		
5313	EFB PAR 13	0...65535	1	0		
5314	EFB PAR 14	0...65535	1	0		
5315	EFB PAR 15	0...65535	1	0		
5316	EFB PAR 16	0...65535	1	0		
5317	EFB PAR 17	0...65535	1	0		
5318	EFB PAR 18	0...65535	1	0		
5319	EFB PAR 19	0000...FFFF hex	1	0		
5320	EFB PAR 20	0000...FFFF hex	1	0		
<b>Group 64: LOAD ANALYZER</b>						
6401	PVL SIGNAL	100...178	1	103 (parameter 0103 OUTPUT FREQ)		
6402	PVL FILTER TIME	0.0...120.0 s	0.1 s	0.1 s		
6403	LOGGERS RESET	-6...7	1	0 (NOT SEL)		
6404	AL2 SIGNAL	101...178	1	103 (parameter 0103 OUTPUT FREQ)		
6405	AL2 SIGNAL BASE	-	-	Depends on the signal selected with par. 6404.		
6406	PEAK VALUE	-	-	-		
6407	PEAK TIME 1	Date dd.mm.yy / power-on time in days	1 d	-		
6408	PEAK TIME 2	Time hh.mm.ss	2 s	-		
6409	CURRENT AT PEAK	0.0...6553.5 A	0.1 A	-		

Code	Name	Range	Resolution	Default	User	S
6410	UDC AT PEAK	0...65535 V	1 V	-		
6411	FREQ AT PEAK	0.0...6553.5 Hz	0.1 Hz	-		
6412	TIME OF RESET 1	Date dd.mm.yy / power-on time in days	1 d	-		
6413	TIME OF RESET 2	Time hh.mm.ss	2 s	-		
6414	AL1RANGE0TO10	0.0...100.0%	0.1%	-		
6415	AL1RANGE10TO20	0.0...100.0%	0.1%	-		
6416	AL1RANGE20TO30	0.0...100.0%	0.1%	-		
6417	AL1RANGE30TO40	0.0...100.0%	0.1%	-		
6418	AL1RANGE40TO50	0.0...100.0%	0.1%	-		
6419	AL1RANGE50TO60	0.0...100.0%	0.1%	-		
6420	AL1RANGE60TO70	0.0...100.0%	0.1%	-		
6421	AL1RANGE70TO80	0.0...100.0%	0.1%	-		
6422	AL1RANGE80TO90	0.0...100.0%	0.1%	-		
6423	AL1RANGE90TO	0.0...100.0%	0.1%	-		
6424	AL2RANGE0TO10	0.0...100.0%	0.1%	-		
6425	AL2RANGE10TO20	0.0...100.0%	0.1%	-		
6426	AL2RANGE20TO30	0.0...100.0%	0.1%	-		
6427	AL2RANGE30TO40	0.0...100.0%	0.1%	-		
6428	AL2RANGE40TO50	0.0...100.0%	0.1%	-		
6429	AL2RANGE50TO60	0.0...100.0%	0.1%	-		
6430	AL2RANGE60TO70	0.0...100.0%	0.1%	-		
6431	AL2RANGE70TO80	0.0...100.0%	0.1%	-		
6432	AL2RANGE80TO90	0.0...100.0%	0.1%	-		
6433	AL2RANGE90TO	0.0...100.0%	0.1%	-		
<b>Group 81: PFC CONTROL</b>						
8103	REFERENCE STEP 1	0.0...100.0%	0.1%	0.0%		
8104	REFERENCE STEP 2	0.0...100.0%	0.1%	0.0%		
8105	REFERENCE STEP 3	0.0...100.0%	0.1%	0.0%		
8109	START FREQ 1	0.0...500.0 Hz	0.1 Hz	-01: 50.0 Hz / -U1: 60.0 Hz		
8110	START FREQ 2	0.0...500.0 Hz	0.1 Hz	-01: 50.0 Hz / -U1: 60.0 Hz		
8111	START FREQ 3	0.0...500.0 Hz	0.1 Hz	-01: 50.0 Hz / -U1: 60.0 Hz		
8112	LOW FREQ 1	0.0...500.0 Hz	0.1 Hz	-01: 25.0 Hz / -U1: 30.0 Hz		
8113	LOW FREQ 2	0.0...500.0 Hz	0.1 Hz	-01: 25.0 Hz / -U1: 30.0 Hz		
8114	LOW FREQ 3	0.0...500.0 Hz	0.1 Hz	-01: 25.0 Hz / -U1: 30.0 Hz		
8115	AUX MOT START D	0.0...3600.0 s	0.1 s	5.0 s		
8116	AUX MOT STOP D	0.0...3600.0 s	0.1 s	3.0 s		
8117	NR OF AUX MOT	0...4	1	1		✓
8118	AUTOCHNG INTERV	-0.1 = TEST MODE, 0.0 = NOT SEL, 0.1...336.0 h	0.1 h	0.0 h (NOT SEL)		✓
8119	AUTOCHNG LEVEL	0.0...100.0%	0.1%	50.0%		
8120	INTERLOCKS	0...6	1	4 (DI4)		✓



Code	Name	Range	Resolution	Default	User	S
8121	REG BYPASS CTRL	0 = NO, 1 = YES	1	0 (NO)		
8122	PFC START DELAY	0.00...10.00 s	0.01 s	0.50 s		
8123	PFC ENABLE	0 = NOT SEL, 1 = ACTIVE	1	0 (NOT SEL)		✓
8124	ACC IN AUX STOP	0.0 = NOT SEL, 0.1...1800.0 s	0.1 s	0.0 s (NOT SEL)		
8125	DEC IN AUX START	0.0 = NOT SEL, 0.1...1800.0 s	0.1 s	0.0 s (NOT SEL)		
8126	TMED AUTOCHNG	0...4	1	0 (NOT SEL)		
8127	MOTORS	1...7	1	2		✓
8128	AUX START ORDER	1 = EVEN RUNTIME, 2 = RELAY ORDER	1	1 (EVEN RUNTIME)		✓
<b>Group 98: OPTIONS</b>						
9802	COMM PROT SEL	0 = NOT SEL, 1 = STD MODBUS, 4 = EXT FBA	1	0 (NOT SEL)		✓

## Complete parameter descriptions

This section describes the actual signals and parameters for ACS550.

### Group 99: START-UP DATA

This group defines special start-up data required to:

- set up the drive
- enter motor information.

Code	Description																								
9901	<p><b>LANGUAGE</b></p> <p>Selects the display language. There are two different Assistant Control Panels, each supporting a different language set. (Panel ACS-CP-L supporting languages 0, 2, 11...15 has been integrated into ACS-CP-A.)</p> <p>Assistant Control Panel ACS-CP-A:</p> <table> <tr> <td>0 = ENGLISH</td> <td>1 = ENGLISH (AM)</td> <td>2 = DEUTSCH</td> <td>3 = ITALIANO</td> <td>4 = ESPAÑOL</td> </tr> <tr> <td>5 = PORTUGUES</td> <td>6 = NEDERLANDS</td> <td>7 = FRANÇAIS</td> <td>8 = DANSK</td> <td>9 = SUOMI</td> </tr> <tr> <td>10 = SVENSKA</td> <td>11 = RUSSKI</td> <td>12 = POLSKI</td> <td>13 = TÜRKÇE</td> <td>14 = CZECH</td> </tr> <tr> <td>15 = MAGYAR</td> <td>16 = ELLINIKA</td> <td></td> <td></td> <td></td> </tr> </table> <p>Assistant Control Panel ACS-CP-D (Asia):</p> <table> <tr> <td>0 = ENGLISH</td> <td>1 = CHINESE</td> <td>2 = KOREAN</td> <td>3 = JAPANESE</td> </tr> </table>	0 = ENGLISH	1 = ENGLISH (AM)	2 = DEUTSCH	3 = ITALIANO	4 = ESPAÑOL	5 = PORTUGUES	6 = NEDERLANDS	7 = FRANÇAIS	8 = DANSK	9 = SUOMI	10 = SVENSKA	11 = RUSSKI	12 = POLSKI	13 = TÜRKÇE	14 = CZECH	15 = MAGYAR	16 = ELLINIKA				0 = ENGLISH	1 = CHINESE	2 = KOREAN	3 = JAPANESE
0 = ENGLISH	1 = ENGLISH (AM)	2 = DEUTSCH	3 = ITALIANO	4 = ESPAÑOL																					
5 = PORTUGUES	6 = NEDERLANDS	7 = FRANÇAIS	8 = DANSK	9 = SUOMI																					
10 = SVENSKA	11 = RUSSKI	12 = POLSKI	13 = TÜRKÇE	14 = CZECH																					
15 = MAGYAR	16 = ELLINIKA																								
0 = ENGLISH	1 = CHINESE	2 = KOREAN	3 = JAPANESE																						
9902	<p><b>APPLIC MACRO</b></p> <p>Selects an application macro. Application macros automatically edit parameters to configure the ACS550 for a particular application.</p> <table> <tr> <td>1 = ABB STANDARD</td> <td>2 = 3-WIRE</td> <td>3 = ALTERNATE</td> <td>4 = MOTOR POT</td> <td>5 = HAND/AUTO</td> </tr> <tr> <td>6 = PID CONTROL</td> <td>7 = PFC CONTROL</td> <td>8 = TORQUE CTRL</td> <td>31 = LOAD FD SET</td> <td></td> </tr> <tr> <td>0 = USER S1 LOAD</td> <td>-1 = USER S1 SAVE</td> <td>-2 = USER S2 LOAD</td> <td>-3 = USER S2 SAVE</td> <td></td> </tr> </table> <p>31 = LOAD FD SET – FlashDrop parameter values as defined by the FlashDrop file. Parameter view is selected by parameter 1611 PARAMETER VIEW.</p> <ul style="list-style-type: none"> <li>• FlashDrop is an optional device for fast copying of parameters to unpowered drives. FlashDrop allows easy customization of the parameter list, e.g. selected parameters can be hidden. For more information, see <i>MFD-01 FlashDrop User's Manual</i> (3AFE68591074 [English]).</li> </ul> <p>-1 = USER S1 SAVE, -3 = USER S2 SAVE – With these it is possible to save two different user parameter sets into the drive permanent memory for later use. Each set contains parameter settings, including <a href="#">Group 99: START-UP DATA</a>, and the results of the motor identification run.</p> <p>0 = USER S1 LOAD, -2 = USER S2 LOAD – With these the user parameter sets can be taken back in use.</p>	1 = ABB STANDARD	2 = 3-WIRE	3 = ALTERNATE	4 = MOTOR POT	5 = HAND/AUTO	6 = PID CONTROL	7 = PFC CONTROL	8 = TORQUE CTRL	31 = LOAD FD SET		0 = USER S1 LOAD	-1 = USER S1 SAVE	-2 = USER S2 LOAD	-3 = USER S2 SAVE										
1 = ABB STANDARD	2 = 3-WIRE	3 = ALTERNATE	4 = MOTOR POT	5 = HAND/AUTO																					
6 = PID CONTROL	7 = PFC CONTROL	8 = TORQUE CTRL	31 = LOAD FD SET																						
0 = USER S1 LOAD	-1 = USER S1 SAVE	-2 = USER S2 LOAD	-3 = USER S2 SAVE																						
9904	<p><b>MOTOR CTRL MODE</b></p> <p>Selects the motor control mode.</p> <p>1 = VECTOR:SPEED – sensorless vector control mode.</p> <ul style="list-style-type: none"> <li>• Reference 1 is speed reference in rpm.</li> <li>• Reference 2 is speed reference in % (100% is absolute maximum speed, equal to the value of parameter 2002 MAXIMUM SPEED, or 2001 MINIMUM SPEED if the absolute value of the minimum speed is greater than the maximum speed).</li> </ul> <p>2 = VECTOR:TORQ.</p> <ul style="list-style-type: none"> <li>• Reference 1 is speed reference in rpm.</li> <li>• Reference 2 is torque reference in % (100% is nominal torque.)</li> </ul> <p>3 = SCALAR:FREQ – scalar control mode.</p> <ul style="list-style-type: none"> <li>• Reference 1 is frequency reference in Hz.</li> <li>• Reference 2 is frequency reference in % (100% is absolute maximum frequency, equal to the value of parameter 2008 MAXIMUM FREQ, or 2007 MINIMUM FREQ if the absolute value of the minimum speed is greater than the maximum speed).</li> </ul>																								

Code	Description
9905	<p><b>MOTOR NOM VOLT</b></p> <p>Defines the nominal motor voltage.</p> <ul style="list-style-type: none"> <li>• Must equal the value on the motor rating plate.</li> <li>• The ACS550 cannot supply the motor with a voltage greater than the input power (mains) voltage.</li> </ul>
9906	<p><b>MOTOR NOM CURR</b></p> <p>Defines the nominal motor current.</p> <ul style="list-style-type: none"> <li>• Must equal the value on the motor rating plate.</li> <li>• Range allowed: <math>0.2 \dots 2.0 \cdot I_{2hd}</math> (where <math>I_{2hd}</math> is drive current).</li> </ul>
9907	<p><b>MOTOR NOM FREQ</b></p> <p>Defines the nominal motor frequency.</p> <ul style="list-style-type: none"> <li>• Range: 10...500 Hz (typically 50 or 60 Hz)</li> <li>• Sets the frequency at which output voltage equals the MOTOR NOM VOLT.</li> <li>• Field weakening point = Nom Freq · Supply Volt / Mot Nom Volt</li> </ul>
9908	<p><b>MOTOR NOM SPEED</b></p> <p>Defines the nominal motor speed.</p> <ul style="list-style-type: none"> <li>• Must equal the value on the motor rating plate.</li> </ul>
9909	<p><b>MOTOR NOM POWER</b></p> <p>Defines the nominal motor power.</p> <ul style="list-style-type: none"> <li>• Must equal the value on the motor rating plate.</li> </ul>
9910	<p><b>ID RUN</b></p> <p>This parameter controls a self-calibration process called the Motor ID Run. During this process, the drive operates the motor (motor rotating) and makes measurements in order to identify motor characteristics and create a model used for internal calculations. An ID Run is especially effective when:</p> <ul style="list-style-type: none"> <li>• vector control mode is used [parameter 9904 = 1 (VECTOR:SPEED) or 2 (VECTOR:TORQ)], and/or</li> <li>• operation point is near zero speed, and/or</li> <li>• operation requires a torque range above the motor nominal torque, over a wide speed range, and without any measured speed feedback (i.e. without a pulse encoder).</li> </ul> <p>0 = OFF/IDMAGN – The Motor ID Run process is not run. Identification magnetization is performed, depending on parameter 9904 and 2101 settings. In identification magnetization, the motor model is calculated at first start by magnetizing the motor for 10 to 15 s at zero speed (motor not rotating). The model is recalculated always at start after motor parameter changes.</p> <ul style="list-style-type: none"> <li>• Parameter 9904 = 1 (VECTOR:SPEED) or 2 (VECTOR:TORQ): Identification magnetization is performed.</li> <li>• Parameter 9904 = 3 (SCALAR:FREQ) and parameter 2101 = 3 (SCALAR FLYST) or 5 (FLY + BOOST): Identification magnetization is performed.</li> <li>• Parameter 9904 = 3 (SCALAR:FREQ) and parameter 2101 has other value than 3 (SCALAR FLYST) or 5 (FLY + BOOST): Identification magnetization is not performed.</li> </ul> <p>1 = ON – Enables the Motor ID Run, during which the motor is rotating, at the next start command. After run completion, this value automatically changes to 0.</p> <p><b>Note:</b> The motor must be de-coupled from the driven equipment.</p> <p><b>Note:</b> If motor parameters are changed after ID Run, repeat the ID Run.</p> <p> <b>WARNING!</b> The motor will run at up to approximately 50...80% of the nominal speed during the ID Run. The motor will rotate in the forward direction.</p> <p><b>Ensure that it is safe to run the motor before performing the ID Run!</b></p> <p>See also section <a href="#">How to perform the ID Run</a> on page 45.</p>
9915	<p><b>MOTOR COSPHI</b></p> <p>Defines the nominal motor cos phi (power factor). The parameter improves performance especially with high efficiency motors.</p> <p>0 = IDENTIFIED – Drive identifies the cos phi automatically by estimation.</p> <p>0.01...0.97 – Value entered used as the cos phi.</p>

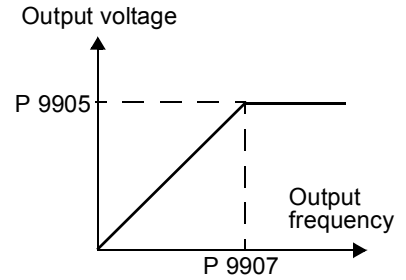

## Group 01: OPERATING DATA

This group contains drive operating data, including actual signals. The drive sets the values for actual signals, based on measurements or calculations. You cannot set these values.

Code	Description
0101	<b>SPEED &amp; DIR</b> The calculated signed speed of the motor (rpm). The absolute value of 0101 SPEED & DIR is the same as the value of 0102 SPEED. <ul style="list-style-type: none"> <li>• The value of 0101 SPEED &amp; DIR is positive if the motor runs in the forward direction.</li> <li>• The value of 0101 SPEED &amp; DIR is negative if the motor runs in the reverse direction.</li> </ul>
0102	<b>SPEED</b> The calculated speed of the motor (rpm). (Parameter 0102 or 0103 is shown by default in the control panel Output mode.)
0103	<b>OUTPUT FREQ</b> The frequency (Hz) applied to the motor. (Parameter 0102 or 0103 is shown by default in the control panel Output mode.)
0104	<b>CURRENT</b> The motor current, as measured by the ACS550. (Shown by default in the control panel Output mode.)
0105	<b>TORQUE</b> Output torque. Calculated value of torque on motor shaft in % of motor nominal torque. (Shown by default in the control panel Output mode.)
0106	<b>POWER</b> The measured motor power in kW.
0107	<b>DC BUS VOLTAGE</b> The DC bus voltage in V DC, as measured by the ACS550.
0109	<b>OUTPUT VOLTAGE</b> The voltage applied to the motor.
0110	<b>DRIVE TEMP</b> The temperature of the drive power transistors in degrees Celsius.
0111	<b>EXTERNAL REF 1</b> External reference, REF1, in rpm or Hz – units determined by parameter 9904.
0112	<b>EXTERNAL REF 2</b> External reference, REF2, in %.
0113	<b>CTRL LOCATION</b> Active control location. Alternatives are: 0 = LOCAL 1 = EXT1 2 = EXT2
0114	<b>RUN TIME (R)</b> The drive's accumulated running time in hours (h). <ul style="list-style-type: none"> <li>• Can be <b>reset</b> by pressing UP and DOWN keys simultaneously when the control panel is in the Parameters mode.</li> </ul>
0115	<b>KWH COUNTER (R)</b> The drive's accumulated power consumption in kilowatt hours. <ul style="list-style-type: none"> <li>• The counter value is accumulated till it reaches 65535 after which the counter rolls over and starts again from 0.</li> <li>• Can be <b>reset</b> by pressing UP and DOWN keys simultaneously when the control panel is in the Parameters mode.</li> </ul>
0116	<b>APPL BLK OUTPUT</b> Application block output signal. Value is from either: <ul style="list-style-type: none"> <li>• PFC control, if PFC Control is active, or</li> <li>• Parameter 0112 EXTERNAL REF 2.</li> </ul>

Code	Description	
0118	<b>DI 1-3 STATUS</b> Status of the three digital inputs. <ul style="list-style-type: none"> <li>• Status is displayed as a binary number.</li> <li>• 1 indicates that the input is activated.</li> <li>• 0 indicates that the input is deactivated.</li> </ul>	
0119	<b>DI 4-6 STATUS</b> Status of the three digital inputs. <ul style="list-style-type: none"> <li>• See parameter 0118 DI 1-3 STATUS.</li> </ul>	
0120	<b>AI 1</b> The relative value of analog input 1 in %.	
0121	<b>AI 2</b> The relative value of analog input 2 in %.	
0122	<b>RO 1-3 STATUS</b> Status of the three relay outputs. <ul style="list-style-type: none"> <li>• 1 indicates that the relay is energized.</li> <li>• 0 indicates that the relay is de-energized.</li> </ul>	
0123	<b>RO 4-6 STATUS</b> Status of the three relay outputs. Available if OREL-01 Relay Output Extension Module is installed. <ul style="list-style-type: none"> <li>• See parameter 0122.</li> </ul>	
0124	<b>AO 1</b> The analog output 1 value in milliamperes.	
0125	<b>AO 2</b> The analog output 2 value in milliamperes.	
0126	<b>PID 1 OUTPUT</b> The PID controller 1 output value in %.	
0127	<b>PID 2 OUTPUT</b> The PID controller 2 output value in %.	
0128	<b>PID 1 SETPNT</b> The PID 1 controller setpoint signal. <ul style="list-style-type: none"> <li>• Units and scale defined by PID parameters.</li> </ul>	
0129	<b>PID 2 SETPNT</b> The PID 2 controller setpoint signal. <ul style="list-style-type: none"> <li>• Units and scale defined by PID parameters.</li> </ul>	
0130	<b>PID 1 FBK</b> The PID 1 controller feedback signal. <ul style="list-style-type: none"> <li>• Units and scale defined by PID parameters.</li> </ul>	
0131	<b>PID 2 FBK</b> The PID 2 controller feedback signal. <ul style="list-style-type: none"> <li>• Units and scale defined by PID parameters.</li> </ul>	
0132	<b>PID 1 DEVIATION</b> The difference between the PID 1 controller reference value and actual value. <ul style="list-style-type: none"> <li>• Units and scale defined by PID parameters.</li> </ul>	
0133	<b>PID 2 DEVIATION</b> The difference between the PID 2 controller reference value and actual value. <ul style="list-style-type: none"> <li>• Units and scale defined by PID parameters.</li> </ul>	
0134	<b>COMM RO WORD</b> Free data location that can be written from serial link. <ul style="list-style-type: none"> <li>• Used for relay output control.</li> <li>• See parameter 1401.</li> </ul>	
0135	<b>COMM VALUE 1</b> Free data location that can be written from serial link.	

Code	Description
0136	<b>COMM VALUE 2</b> Free data location that can be written from serial link.
0137	<b>PROCESS VAR 1</b> Process variable 1 • Defined by parameters in <a href="#">Group 34: PANEL DISPLAY</a> .
0138	<b>PROCESS VAR 2</b> Process variable 2 • Defined by parameters in <a href="#">Group 34: PANEL DISPLAY</a> .
0139	<b>PROCESS VAR 3</b> Process variable 3 • Defined by parameters in <a href="#">Group 34: PANEL DISPLAY</a> .
0140	<b>RUN TIME</b> The drive's accumulated running time in thousands of hours (kh). • Cannot be reset.
0141	<b>MWH COUNTER</b> The drive's accumulated power consumption in megawatt hours. • The counter value is accumulated till it reaches 65535 after which the counter rolls over and starts again from 0. • Cannot be reset.
0142	<b>REVOLUTION CNTR</b> The motor's accumulated revolutions in millions of revolutions. • Can be reset by pressing UP and DOWN keys simultaneously when the control panel is in the Parameters mode.
0143	<b>DRIVE ON TIME HI</b> The drive's accumulated power-on time in days. • Cannot be reset.
0144	<b>DRIVE ON TIME LO</b> The drive's accumulated power-on time in 2 second ticks (30 ticks = 60 seconds). • Shown in format hh.mm.ss. • Cannot be reset.
0145	<b>MOTOR TEMP</b> Motor temperature in degrees Celsius / PTC resistance in ohms. • Applies only if motor temperature sensor is set up. • See parameter 3501.
0146	<b>MECH ANGLE</b> Defines the motor shaft's angular position to about 0.01° (32,768 divisions for 360°). The position is defined as 0 at power up. During operation the zero position can be set by: • a Z-pulse input, if parameter 5010 Z PLS ENABLE = 1 (ENABLE) • parameter 5011 POSITION RESET, if parameter 5010 Z PLS ENABLE = 2 (DISABLE) • any status change of parameter 5002 ENCODER ENABLE.
0147	<b>MECH REVS</b> A signed integer that counts full revolutions of the motor shaft. The value: • increments when parameter 0146 MECH ANGLE changes from 32767 to 0 • decrements when parameter 0146 MECH ANGLE changes from 0 to 32767.
0148	<b>Z PLS DETECTED</b> Encoder zero pulse detector. When a Z-pulse defines the zero position, the shaft must pass through the zero position to trigger a Z-pulse. Until then, the shaft position is unknown (the drive uses the shaft position at power up as zero). This parameter signals when parameter 0146 MECH ANGLE is valid. The parameter starts at 0 = NOT DETECTED on power-up and changes to 1 = DETECTED only if: • parameter 5010 Z PLS ENABLE = 1 (ENABLE) and • an encoder Z-pulse has been detected.
0150	<b>CB TEMP</b> Temperature of the drive control board in degrees Celsius. <b>Note:</b> Some drives have a control board (OMIO) that does not support this feature. These drives always show the constant value of 25.0 °C.

Code	Description
0153	<p><b>MOT THERM STRESS</b></p> <p>Estimated rise of the motor temperature. Value equals to the estimated motor thermal stress as a percentage of the motor temperature trip level.</p>
0158	<p><b>PID COMM VALUE 1</b></p> <p>Data received from fieldbus for PID control (PID1 and PID2).</p>
0159	<p><b>PID COMM VALUE 2</b></p> <p>Data received from fieldbus for PID control (PID1 and PID2).</p>
0174	<p><b>SAVED KWH</b></p> <p>Energy saved in kWh compared to the energy used when the pump is connected directly to the supply. See the note on page <a href="#">180</a>.</p> <ul style="list-style-type: none"> <li>The counter value is accumulated till it reaches 999.9 after which the counter rolls over and starts again from 0.0 and the counter value of signal 0175 is incremented by one. Can be reset with parameter 4509 ENERGY RESET (resets all energy calculators at the same time).</li> <li>See <a href="#">Group 45: ENERGY SAVING</a>.</li> </ul>
0175	<p><b>SAVED MWH</b></p> <p>Energy saved in MWh compared to the energy used when the pump is connected directly to the supply. See the note on page <a href="#">180</a>.</p> <ul style="list-style-type: none"> <li>The counter value is accumulated till it reaches 65535 after which the counter rolls over and starts again from 0.</li> <li>Can be reset with parameter 4509 ENERGY RESET (resets all energy calculators at the same time).</li> <li>See <a href="#">Group 45: ENERGY SAVING</a>.</li> </ul>
0176	<p><b>SAVED AMOUNT 1</b></p> <p>Energy saved in local currency (remainder when the total saved energy is divided by 1000). See the note on page <a href="#">180</a>.</p> <ul style="list-style-type: none"> <li>To find out the total saved energy in currency units, add the value of parameter 0177 multiplied by 1000 to the value of parameter 0176.</li> </ul> <p><b>Example:</b></p> <p>0176 SAVED AMOUNT 1 = 123.4  0177 SAVED AMOUNT 2 = 5  Total saved energy = 5 · 1000 + 123.4 = 5123.4 currency units.</p> <ul style="list-style-type: none"> <li>The counter value is accumulated till it reaches 999.9 after which the counter rolls over and starts again from 0.0 and the counter value of signal 0177 is incremented by one.</li> <li>Can be reset with parameter 4509 ENERGY RESET (resets all energy calculators at the same time).</li> <li>Local energy price is set with parameter 4502 ENERGY PRICE.</li> <li>See <a href="#">Group 45: ENERGY SAVING</a>.</li> </ul>
0177	<p><b>SAVED AMOUNT 2</b></p> <p>Energy saved in local currency in thousand currency units. Eg value 5 means 5000 currency units. See the note on page <a href="#">180</a>.</p> <ul style="list-style-type: none"> <li>The counter value is accumulated till it reaches 65535 (the counter does not roll over).</li> <li>See parameter 0176 SAVED AMOUNT 1.</li> </ul>
0178	<p><b>SAVED CO2</b></p> <p>Reduction on carbon dioxide emissions in tn. See the note on page <a href="#">180</a>.</p> <ul style="list-style-type: none"> <li>The counter value is accumulated till it reaches 6553.5 (the counter does not roll over).</li> <li>Can be reset with parameter 4509 ENERGY RESET (resets all energy calculators at the same time).</li> <li>CO2 conversion factor is set with parameter 4507 CO2 CONV FACTOR.</li> <li>See <a href="#">Group 45: ENERGY SAVING</a>.</li> </ul>

### Group 03: FB ACTUAL SIGNALS

This group monitors fieldbus communications.

Code	Description			
0301	<b>FB CMD WORD 1</b> Read-only copy of the Fieldbus Command Word 1. <ul style="list-style-type: none"> <li>The fieldbus command is the principal means for controlling the drive from a fieldbus controller. The command consists of two Command Words. Bit-coded instructions in the Command Words switch the drive between states.</li> <li>To control the drive, using the Command Words, an external location (EXT1 or EXT2) must be active and set to COMM. (See parameters 1001 and 1002.)</li> <li>The control panel displays the word in hex. For example, all zeros and a 1 in Bit 0 displays as 0001. All zeros and a 1 in Bit 15 displays as 8000.</li> </ul>	<b>Bit #</b>	<b>0301, FB CMD WORD 1</b>	<b>0302, FB CMD WORD 2</b>
		0	STOP	FBLOCAL_CTL
		1	START	FBLOCAL_REF
		2	REVERSE	START_DISABLE1
		3	LOCAL	START_DISABLE2
		4	RESET	Reserved
		5	EXT2	Reserved
		6	RUN_DISABLE	Reserved
		7	STPMODE_R	Reserved
		8	STPMODE_EM	Reserved
		9	STPMODE_C	Reserved
		10	RAMP_2	Reserved
		11	RAMP_OUT_0	REF_CONST
		12	RAMP_HOLD	REF_AVE
		13	RAMP_IN_0	LINK_ON
0302	<b>FB CMD WORD 2</b> Read-only copy of the Fieldbus Command Word 2. <ul style="list-style-type: none"> <li>See parameter 0301.</li> </ul>	14	RREQ_LOCALLOC	REQ_STARTINH
		15	TORQLIM2	OFF_INTERLOCK
0303	<b>FB STS WORD 1</b> Read-only copy of the Status Word 1. <ul style="list-style-type: none"> <li>The drive sends status information to the fieldbus controller. The status consists of two Status Words.</li> <li>The control panel displays the word in hex. For example, all zeros and a 1 in Bit 0 displays as 0001. All zeros and a 1 in Bit 15 displays as 8000.</li> </ul>	<b>Bit #</b>	<b>0303, FB STS WORD 1</b>	<b>0304, FB STS WORD 2</b>
		0	READY	ALARM
		1	ENABLED	NOTICE
		2	STARTED	DIRLOCK
		3	RUNNING	LOCALLOCK
		4	ZERO_SPEED	CTL_MODE
		5	ACCELERATE	Reserved
		6	DECELERATE	Reserved
		7	AT_SETPOINT	CPY_CTL
		8	LIMIT	CPY_REF1
0304	<b>FB STS WORD 2</b> Read-only copy of the Status Word 2. <ul style="list-style-type: none"> <li>See parameter 0303.</li> </ul>	9	SUPERVISION	CPY_REF2
		10	REV_REF	REQ_CTL
		11	REV_ACT	REQ_REF1
		12	PANEL_LOCAL	REQ_REF2
		13	FIELDBUS_LOCAL	REQ_REF2EXT
		14	EXT2_ACT	ACK_STARTINH
		15	FAULT	ACK_OFF_ILCK



Code	Description				
0305	<b>FAULT WORD 1</b> Read-only copy of the Fault Word 1. <ul style="list-style-type: none"> <li>When a fault is active, the corresponding bit for the active fault is set in the Fault Words.</li> <li>Each fault has a dedicated bit allocated within Fault Words.</li> <li>See section <a href="#">Fault listing</a> on page 260 for a description of the faults.</li> <li>The control panel displays the word in hex. For example, all zeros and a 1 in Bit 0 displays as 0001. All zeros and a 1 in Bit 15 displays as 8000.</li> </ul>	<b>Bit #</b>	<b>0305, FAULT WORD 1</b>	<b>0306, FAULT WORD 2</b>	<b>0307, FAULT WORD 3</b>
		0	OVERCURRENT	Obsolete	EFB 1
		1	DC OVERVOLT	THERM FAIL	EFB 2
		2	DEV OVERTEMP	OPEX LINK	EFB 3
		3	SHORT CIRC	OPEX PWR	INCOMPATIBLE SW
		4	Reserved	CURR MEAS	USER LOAD CURVE
		5	DC UNDERVOLT	SUPPLY PHASE	Reserved
		6	AI1 LOSS	ENCODER ERR	Reserved
		7	AI2 LOSS	OVERSPEED	Reserved
		8	MOT OVERTEMP	Reserved	Reserved
		9	PANEL LOSS	DRIVE ID	Reserved
		10	ID RUN FAIL	CONFIG FILE	System error
		11	MOTOR STALL	SERIAL 1 ERR	System error
		12	CB OVERTEMP	EFB CON FILE	System error
		13	EXT FAULT 1	FORCE TRIP	System error
		14	EXT FAULT 2	MOTOR PHASE	System error
15	EARTH FAULT	OUTP WIRING	Param. setting fault		
0306	<b>FAULT WORD 2</b> Read-only copy of the Fault Word 2. <ul style="list-style-type: none"> <li>See parameter 0305.</li> </ul>				
0307	<b>FAULT WORD 3</b> Read-only copy of the Fault Word 3. <ul style="list-style-type: none"> <li>See parameter 0305.</li> </ul>				
0308	<b>ALARM WORD 1</b> <ul style="list-style-type: none"> <li>When an alarm is active, the corresponding bit for the active alarm is set in the Alarm Words.</li> <li>Each alarm has a dedicated bit allocated within Alarm Words.</li> <li>Bits remain set until the whole alarm word is reset. (Reset by writing zero to the word.)</li> <li>The control panel displays the word in hex. For example, all zeros and a 1 in Bit 0 displays as 0001. All zeros and a 1 in Bit 15 displays as 8000.</li> </ul>	<b>Bit #</b>	<b>0308, ALARM WORD 1</b>	<b>0309, ALARM WORD 2</b>	
		0	OVERCURRENT	Reserved	
		1	OVERVOLTAGE	PID SLEEP	
		2	UNDERVOLTAGE	ID RUN	
		3	DIR LOCK	Reserved	
		4	IO COMM	START ENABLE 1 MISSING	
		5	AI1 LOSS	START ENABLE 2 MISSING	
		6	AI2 LOSS	EMERGENCY STOP	
		7	PANEL LOSS	ENCODER ERROR	
		8	DEVICE OVERTEMP	FIRST START	
		9	MOTOR TEMP	Reserved	
		10	Reserved	USER LOAD CURVE	
		11	MOTOR STALL	START DELAY	
		12	AUTORESET	Reserved	
		13	AUTOCHANGE	Reserved	
		14	PFC I LOCK	Reserved	
15	Reserved	Reserved			
0309	<b>ALARM WORD 2</b> See parameter 0308.				

## Group 04: FAULT HISTORY

This group stores a recent history of the faults reported by the drive.

Code	Description
0401	<p><b>LAST FAULT</b></p> <p>0 – Clear the fault history (on panel = NO RECORD).            n – Fault code of the last recorded fault. The fault code is displayed as a name. See section <a href="#">Fault listing</a> on page 260 for the fault codes and names. The fault name shown for this parameter may be shorter than the corresponding name in the fault listing, which shows the names as they are shown in the fault display.</p>
0402	<p><b>FAULT TIME 1</b></p> <p>The day on which the last fault occurred. Either as:</p> <ul style="list-style-type: none"> <li>• A date – if real time clock is operating.</li> <li>• The number of days after power on – if real time clock is not used, or was not set.</li> </ul>
0403	<p><b>FAULT TIME 2</b></p> <p>The time at which the last fault occurred. Either as:</p> <ul style="list-style-type: none"> <li>• Real time, in format hh:mm:ss – if real time clock is operating.</li> <li>• The time since power on (minus the whole days reported in 0402), in format hh:mm:ss – if real time clock is not used, or was not set.</li> <li>• Format on the Basic Control Panel: The time since power on in 2-second ticks (minus the whole days reported in 0402). 30 ticks = 60 seconds. E.g. Value 514 equals 17 minutes and 8 seconds (= 514/30).</li> </ul>
0404	<p><b>SPEED AT FLT</b></p> <p>The motor speed (rpm) at the time the last fault occurred.</p>
0405	<p><b>FREQ AT FLT</b></p> <p>The frequency (Hz) at the time the last fault occurred.</p>
0406	<p><b>VOLTAGE AT FLT</b></p> <p>The DC bus voltage (V) at the time the last fault occurred.</p>
0407	<p><b>CURRENT AT FLT</b></p> <p>The motor current (A) at the time the last fault occurred.</p>
0408	<p><b>TORQUE AT FLT</b></p> <p>The motor torque (%) at the time the last fault occurred.</p>
0409	<p><b>STATUS AT FLT</b></p> <p>The drive status (hex code word) at the time the last fault occurred.</p>
0410	<p><b>DI 1-3 AT FLT</b></p> <p>The status of digital inputs 1...3 at the time the last fault occurred.</p>
0411	<p><b>DI 4-6 AT FLT</b></p> <p>The status of digital inputs 4...6 at the time the last fault occurred.</p>
0412	<p><b>PREVIOUS FAULT 1</b></p> <p>Fault code of the second last fault. Read-only.</p>
0413	<p><b>PREVIOUS FAULT 2</b></p> <p>Fault code of the third last fault. Read-only.</p>

**Group 10: START/STOP/DIR**

This group:

- defines external sources (EXT1 and EXT2) for commands that enable start, stop and direction changes
- locks direction or enables direction control.

To select between the two external locations use the next group (parameter 1102).

Code	Description
1001	<p><b>EXT1 COMMANDS</b></p> <p>Defines external control location 1 (EXT1) – the configuration of start, stop and direction commands.</p> <p>0 = NOT SEL – No external start, stop and direction command source.</p> <p>1 = DI1 – Two-wire Start/Stop.</p> <ul style="list-style-type: none"> <li>• Start/Stop is through digital input DI1 (DI1 activated = Start; DI1 de-activated = Stop).</li> <li>• Parameter 1003 defines the direction. Selecting 1003 = 3 (REQUEST) is the same as 1003 = 1 (FORWARD).</li> </ul> <p>2 = DI1,2 – Two-wire Start/Stop, Direction.</p> <ul style="list-style-type: none"> <li>• Start/Stop is through digital input DI1 (DI1 activated = Start; DI1 de-activated = Stop).</li> <li>• Direction control [requires parameter 1003 = 3 (REQUEST)] is through digital input DI2 (DI2 activated = Reverse; de-activated = Forward).</li> </ul> <p>3 = DI1P,2P – Three-wire Start/Stop.</p> <ul style="list-style-type: none"> <li>• Start/Stop commands are through momentary push-buttons (the P stands for “pulse”).</li> <li>• Start is through a normally open push-button connected to digital input DI1. In order to start the drive, the digital input DI2 must be activated prior to the pulse in DI1.</li> <li>• Connect multiple Start push-buttons in parallel.</li> <li>• Stop is through a normally closed push-button connected to digital input DI2.</li> <li>• Connect multiple Stop push-buttons in series.</li> <li>• Parameter 1003 defines the direction. Selecting 1003 = 3 (REQUEST) is the same as 1003 = 1 (FORWARD).</li> </ul> <p>4 = DI1P,2P,3 – Three-wire Start/Stop, Direction.</p> <ul style="list-style-type: none"> <li>• Start/Stop commands are through momentary push-buttons, as described for DI1P,2P.</li> <li>• Direction control [requires parameter 1003 = 3 (REQUEST)] is through digital input DI3 (DI3 activated = Reverse; de-activated = Forward).</li> </ul> <p>5 = DI1P,2P,3P – Start Forward, Start Reverse and Stop.</p> <ul style="list-style-type: none"> <li>• Start and Direction commands are given simultaneously with two separate momentary push-buttons (the P stands for “pulse”).</li> <li>• Start Forward command is through a normally open push-button connected to digital input DI1. In order to start the drive, the digital input DI3 must be activated prior to the pulse in DI1.</li> <li>• Start Reverse command is through a normally open push-button connected to digital input DI2. In order to start the drive, the digital input DI3 must be activated during the pulse in DI2.</li> <li>• Connect multiple Start push-buttons in parallel.</li> <li>• Stop is through a normally closed push-button connected to digital input DI3.</li> <li>• Connect multiple Stop push-buttons in series.</li> <li>• Requires parameter 1003 = 3 (REQUEST).</li> </ul> <p>6 = DI6 – Two-wire Start/Stop.</p> <ul style="list-style-type: none"> <li>• Start/Stop is through digital input DI6 (DI6 activated = Start; DI6 de-activated = Stop).</li> <li>• Parameter 1003 defines the direction. Selecting 1003 = 3 (REQUEST) is the same as 1003 = 1 (FORWARD).</li> </ul> <p>7 = DI6,5 – Two-wire Start/Stop/Direction.</p> <ul style="list-style-type: none"> <li>• Start/Stop is through digital input DI6 (DI6 activated = Start; DI6 de-activated = Stop).</li> <li>• Direction control [requires parameter 1003 = 3 (REQUEST)] is through digital input DI5. (DI5 activated = Reverse; de-activated = Forward).</li> </ul> <p>8 = KEYPAD – Control Panel.</p> <ul style="list-style-type: none"> <li>• Start/Stop and Direction commands are through the control panel when EXT1 is active.</li> <li>• Direction control requires parameter 1003 = 3 (REQUEST).</li> </ul> <p>9 = DI1F,2R – Start/Stop/Direction commands through DI1 and DI2 combinations.</p> <ul style="list-style-type: none"> <li>• Start forward = DI1 activated and DI2 de-activated.</li> <li>• Start reverse = DI1 de-activated and DI2 activated.</li> <li>• Stop = both DI1 and DI2 activated, or both de-activated.</li> <li>• Requires parameter 1003 = 3 (REQUEST).</li> </ul> <p>10 = COMM – Assigns the fieldbus Command Word as the source for the start/stop and direction commands.</p> <ul style="list-style-type: none"> <li>• Bits 0,1, 2 of Command Word 1 (parameter 0301) activates the start/stop and direction commands.</li> <li>• See Fieldbus user's manual for detailed instructions.</li> </ul>

Code	Description
	11 = TIMED FUNC 1. – Assigns Start/Stop control to Timed Function 1 (Timed Function activated = START; Timed Function de-activated = STOP). See <a href="#">Group 36: TIMED FUNCTIONS</a> . 12...14 = TIMED FUNC 2...4 – Assigns Start/Stop control to Timed Function 2...4. See TIMED FUNC 1 above.
1002	<b>EXT2 COMMANDS</b> Defines external control location 2 (EXT2) – the configuration of start, stop and direction commands. • See parameter 1001 EXT1 COMMANDS above.
1003	<b>DIRECTION</b> Defines the control of motor rotation direction. 1 = FORWARD – Rotation is fixed in the forward direction. 2 = REVERSE – Rotation is fixed in the reverse direction. 3 = REQUEST – Rotation direction can be changed on command.
1004	<b>JOGGING SEL</b> Defines the signal that activates the jogging function. Jogging uses Constant Speed 7 (parameter 1208) for speed reference and ramp pair 2 (parameters 2205 and 2206) for accelerating and decelerating. When the jogging activation signal is lost, the drive uses ramp stop to decelerate to zero speed, even if coast stop is used in normal operation (parameter 2102). The jogging status can be parameterized to relay outputs (parameter 1401). The jogging status is also seen in DCU Profile status bit 21. 0 = NOT SEL – Disables the jogging function. 1 = DI1 – Activates/de-activates jogging based on the state of DI1 (DI1 activated = jogging active; DI1 de-activated = jogging inactive). 2...6 = DI2...DI6 – Activates jogging based on the state of the selected digital input. See DI1 above. -1 = DI1(INV) – Activates jogging based on the state of DI1 (DI1 activated = jogging inactive; DI1 de-activated = jogging active). -2...-6 = DI2(INV)...DI6(INV) – Activates jogging based on the state of the selected digital input. See DI1(INV) above.

### Group 11: REFERENCE SELECT

This group defines:

- how the drive selects between command sources
- characteristics and sources for REF1 and REF2.

Code	Description
1101	<p><b>KEYPAD REF SEL</b></p> <p>Selects the reference controlled in local control mode.</p> <p>1 = REF1(Hz/rpm) – Reference type depends on parameter 9904 MOTOR CTRL MODE.</p> <ul style="list-style-type: none"> <li>• Speed reference (rpm) if 9904 = 1 (VECTOR:SPEED) or 2 (VECTOR:TORQ).</li> <li>• Frequency reference (Hz) if 9904 = 3 (SCALAR:FREQ).</li> </ul> <p>2 = REF2(%)</p>
1102	<p><b>EXT1/EXT2 SEL</b></p> <p>Defines the source for selecting between the two external control locations EXT1 or EXT2. Thus, defines the source for Start/Stop/Direction commands and reference signals.</p> <p>0 = EXT1 – Selects external control location 1 (EXT1).</p> <ul style="list-style-type: none"> <li>• See parameter 1001 EXT1 COMMANDS for EXT1's Start/Stop/Dir definitions.</li> <li>• See parameter 1103 REF1 SELECT for EXT1's reference definitions.</li> </ul> <p>1 = DI1 – Assigns control to EXT1 or EXT2 based on the state of DI1 (DI1 activated = EXT2; DI1 de-activated = EXT1).</p> <p>2...6 = DI2...DI6 – Assigns control to EXT1 or EXT2 based on the state of the selected digital input. See DI1 above.</p> <p>7 = EXT2 – Selects external control location 2 (EXT2).</p> <ul style="list-style-type: none"> <li>• See parameter 1002 EXT2 COMMANDS for EXT2's Start/Stop/Dir definitions.</li> <li>• See parameter 1106 REF2 SELECT for EXT2's reference definitions.</li> </ul> <p>8 = COMM – Assigns control of the drive via external control location EXT1 or EXT2 based on the fieldbus control word.</p> <ul style="list-style-type: none"> <li>• Bit 5 of the Command Word 1 (parameter 0301) defines the active external control location (EXT1 or EXT2).</li> <li>• See Fieldbus user's manual for detailed instructions.</li> </ul> <p>9 = TIMED FUNC 1 – Assigns control to EXT1 or EXT2 based on the state of the Timed Function (Timed Function activated = EXT2; Timed Function de-activated = EXT1). See <a href="#">Group 36: TIMED FUNCTIONS</a>.</p> <p>10...12 = TIMED FUNC 2...4 – Assigns control to EXT1 or EXT2 based on the state of the Timed Function. See TIMED FUNC 1 above.</p> <p>-1 = DI1(INV) – Assigns control to EXT1 or EXT2 based on the state of DI1 (DI1 activated = EXT1; DI1 de-activated = EXT2).</p> <p>-2...-6 = DI2(INV)...DI6(INV) – Assigns control to EXT1 or EXT2 based on the state of the selected digital input. See DI1(INV) above.</p>
1103	<p><b>REF1 SELECT</b></p> <p>Selects the signal source for external reference REF1.</p> <p>0 = KEYPAD – Defines the control panel as the reference source.</p> <p>1 = AI1 – Defines analog input 1 (AI1) as the reference source.</p> <p>2 = AI2 – Defines analog input 2 (AI2) as the reference source.</p> <p>3 = AI1/JOYST – Defines analog input 1 (AI1), configured for joystick operation, as the reference source.</p> <ul style="list-style-type: none"> <li>• The minimum input signal runs the drive at the maximum reference in the reverse direction. Define the minimum using parameter 1104.</li> <li>• The maximum input signal runs the drive at maximum reference in the forward direction. Define the maximum using parameter 1105.</li> <li>• Requires parameter 1003 = 3 (REQUEST).</li> </ul> <p><b>⚠ WARNING!</b> Because the low end of the reference range commands full reverse operation, do not use 0 V as the lower end of the reference range. Doing so means that if the control signal is lost (which is a 0 V input) the result is full reverse operation. Instead, use the following set-up so that loss of the analog input triggers a fault, stopping the drive:</p> <ul style="list-style-type: none"> <li>• Set parameter 1301 MINIMUM AI1 (1304 MINIMUM AI2) at 20% (2 V or 4 mA).</li> <li>• Set parameter 3021 AI1 FAULT LIMIT to a value 5% or higher.</li> <li>• Set parameter 3001 AI&lt;MIN FUNCTION to 1 (FAULT).</li> </ul> <p>4 = AI2/JOYST – Defines analog input 2 (AI2), configured for joystick operation, as the reference source.</p> <ul style="list-style-type: none"> <li>• See above (AI1/JOYST) description.</li> </ul>

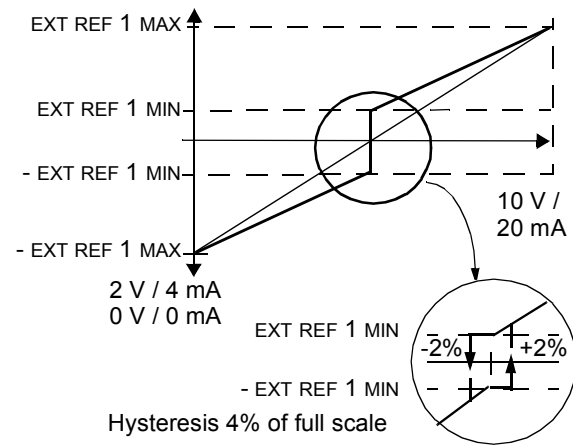

Code	Description
5 = DI3U,4D(R)	<ul style="list-style-type: none"> <li>Defines digital inputs as the speed reference source (motor potentiometer control).</li> <li>Digital input DI3 increases the speed (the U stands for "up").</li> <li>Digital input DI4 decreases the speed (the D stands for "down").</li> <li>A Stop command resets the reference to zero (the R stands for "reset").</li> <li>Parameter 2205 ACCELER TIME 2 controls the reference signal's rate of change.</li> </ul>
6 = DI3U,4D	<ul style="list-style-type: none"> <li>Same as above (DI3U,4D(R)), except:</li> <li>A Stop command does not reset the reference to zero. The reference is stored.</li> <li>When the drive restarts, the motor ramps up (at the selected acceleration rate) to the stored reference.</li> </ul>
7 = DI5U,6D	<ul style="list-style-type: none"> <li>Same as above (DI3U,4D), except that DI5 and DI6 are the digital inputs used.</li> </ul>
8 = COMM	<ul style="list-style-type: none"> <li>Defines the fieldbus as the reference source.</li> </ul>
9 = COMM+AI1	<ul style="list-style-type: none"> <li>Defines a fieldbus and analog input 1 (AI1) combination as the reference source. See Analog input reference correction below.</li> </ul>
10 = COMM*AI1	<ul style="list-style-type: none"> <li>Defines a fieldbus and analog input 1 (AI1) combination as the reference source. See Analog input reference correction below.</li> </ul>
11 = DI3U,4D(RNC)	<ul style="list-style-type: none"> <li>Same as DI3U,4D(R) above, except that:</li> <li>Changing the control source (EXT1 to EXT2, EXT2 to EXT1, LOC to REM) does not copy the reference.</li> </ul>
12 = DI3U,4D(NC)	<ul style="list-style-type: none"> <li>Same as DI3U,4D above, except that:</li> <li>Changing the control source (EXT1 to EXT2, EXT2 to EXT1, LOC to REM) does not copy the reference.</li> <li>Stop command resets reference to zero.</li> </ul>
13 = DI5U,6D(NC)	<ul style="list-style-type: none"> <li>Same as DI5U,6D above, except that:</li> <li>Changing the control source (EXT1 to EXT2, EXT2 to EXT1, LOC to REM) does not copy the reference.</li> </ul>
14 = AI1+AI2	<ul style="list-style-type: none"> <li>Defines an analog input 1 (AI1) and analog input 2 (AI2) combination as the reference source. See Analog input reference correction below.</li> </ul>
15 = AI1*AI2	<ul style="list-style-type: none"> <li>Defines an analog input 1 (AI1) and analog input 2 (AI2) combination as the reference source. See Analog input reference correction below.</li> </ul>
16 = AI1-AI2	<ul style="list-style-type: none"> <li>Defines an analog input 1 (AI1) and analog input 2 (AI2) combination as the reference source. See Analog input reference correction below.</li> </ul>
17 = AI1/AI2	<ul style="list-style-type: none"> <li>Defines an analog input 1 (AI1) and analog input 2 (AI2) combination as the reference source. See Analog input reference correction below.</li> </ul>
20 = KEYPAD(RNC)	<ul style="list-style-type: none"> <li>Defines the control panel as the reference source.</li> <li>A Stop command resets the reference to zero (the R stands for reset.).</li> <li>Changing the control source (EXT1 to EXT2, EXT2 to EXT1) does not copy the reference.</li> </ul>
21 = KEYPAD(NC)	<ul style="list-style-type: none"> <li>Defines the control panel as the reference source.</li> <li>A Stop command does not reset the reference to zero. The reference is stored.</li> <li>Changing the control source (EXT1 to EXT2, EXT2 to EXT1) does not copy the reference.</li> </ul>

**Analog input reference correction**

Parameter values 9, 10 and 14...17 use the formula in the following table.

Value setting	Calculation of the AI reference
C + B	C value + (B value - 50% of reference value)
C * B	C value · (B value / 50% of reference value)
C - B	(C value + 50% of reference value) - B value
C / B	(C value · 50% of reference value) / B value

Where:

- C = Main reference value  
(= COMM for values 9, 10 and  
= AI1 for values 14...17).
- B = Correcting reference  
(= AI1 for values 9, 10 and  
= AI2 for values 14...17).

**Example:**

The figure shows the reference source curves for value settings 9, 10 and 14...17, where:

- C = 25%.
- P 4012 SETPOINT MIN = 0.
- P 4013 SETPOINT MAX = 0.
- B varies along the horizontal axis.

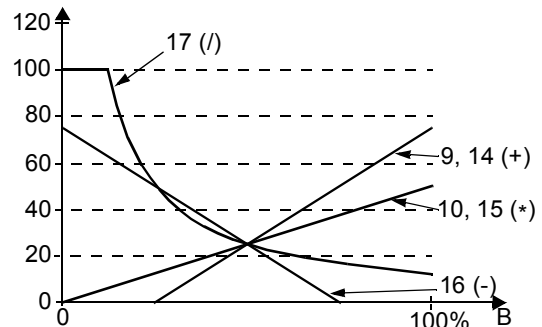

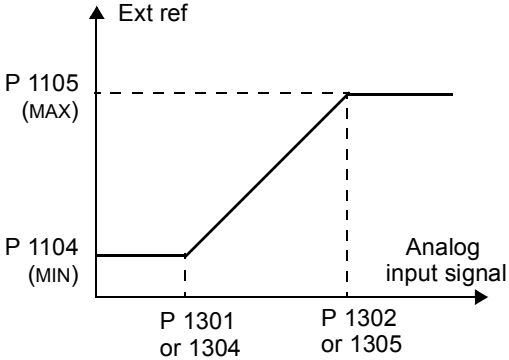
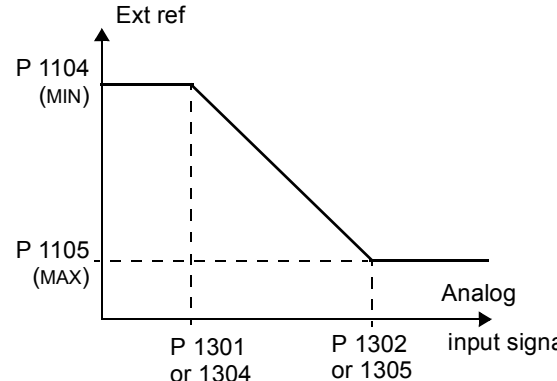
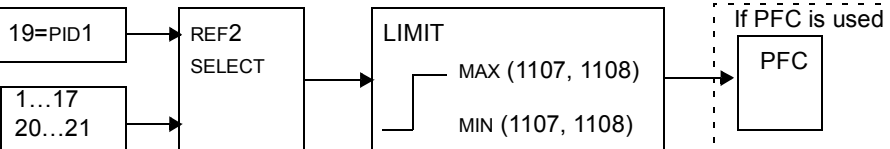
Code	Description	
1104	<p><b>REF1 MIN</b></p> <p>Sets the minimum for external reference 1.</p> <ul style="list-style-type: none"> <li>The minimum analog input signal (as a percent of the full signal in volts or amperes) corresponds to REF1 MIN in Hz/rpm.</li> <li>Parameter 1301 MINIMUM AI1 or 1304 MINIMUM AI2 sets the minimum analog input signal.</li> <li>These parameters (reference and analog min. and max. settings) provide scale and offset adjustment for the reference.</li> </ul>	
1105	<p><b>REF1 MAX</b></p> <p>Sets the maximum for external reference 1.</p> <ul style="list-style-type: none"> <li>The maximum analog input signal (as a percent of full the signal in volts or amperes) corresponds to REF1 MAX in Hz/rpm.</li> <li>Parameter 1302 MAXIMUM AI1 or 1305 MAXIMUM AI2 sets the maximum analog input signal.</li> </ul>	
1106	<p><b>REF2 SELECT</b></p> <p>Selects the signal source for external reference REF2.</p> <p>0...17 – Same as for parameter 1103 REF1 SELECT.</p> <p>19 = PID1OUT – The reference is taken from the PID1 output. See <a href="#">Group 40: PROCESS PID SET 1</a> and <a href="#">Group 41: PROCESS PID SET 2</a>.</p> <p>20...21 – Same as for parameter 1103 REF1 SELECT.</p>	
1107	<p><b>REF2 MIN</b></p> <p>Sets the minimum for external reference 2.</p> <ul style="list-style-type: none"> <li>The minimum analog input signal (in volts or amperes) corresponds to REF2 MIN in %.</li> <li>Parameter 1301 MINIMUM AI1 or 1304 MINIMUM AI2 sets the minimum analog input signal.</li> <li>This parameter sets the minimum frequency reference.</li> <li>The value is a percentage of the: <ul style="list-style-type: none"> <li>– maximum frequency or speed</li> <li>– maximum process reference</li> <li>– nominal torque.</li> </ul> </li> </ul>	
1108	<p><b>REF2 MAX</b></p> <p>Sets the maximum for external reference 2.</p> <ul style="list-style-type: none"> <li>The maximum analog input signal (in volts or amperes) corresponds to REF2 MAX in %.</li> <li>Parameter 1302 MAXIMUM AI1 or 1305 MAXIMUM AI2 sets the maximum analog input signal.</li> <li>This parameter sets the maximum frequency reference.</li> <li>The value is a percentage of the: <ul style="list-style-type: none"> <li>– maximum frequency or speed</li> <li>– maximum process reference</li> <li>– nominal torque.</li> </ul> </li> </ul>	

## Group 12: CONSTANT SPEEDS

This group defines a set of constant speeds. In general:

- You can program up to 7 constant speeds, ranging from 0...500 Hz or 0...30000 rpm.
- Values must be positive (No negative speed values for constant speeds).
- Constant speed selections are ignored if:
  - the torque control is active, or
  - the process PID reference is followed, or
  - the drive is in local control mode, or
  - PFC (Pump-Fan Control) is active.

**Note:** Parameter 1208 CONST SPEED 7 acts also as a so-called fault speed which may be activated if the control signal is lost. For example, see parameters 3001 AI<MIN FUNCTION, 3002 PANEL COMM ERR and 3018 COMM FAULT FUNC.

Code	Description																																																			
1201	<p><b>CONST SPEED SEL</b>            Defines the digital inputs used to select Constant Speeds. See general comments in introduction.            0 = NOT SEL – Disables the constant speed function.            1 = DI1 – Selects Constant Speed 1 with digital input DI1.            • Digital input activated = Constant Speed 1 activated.            2...6 = DI2...DI6 – Selects Constant Speed 1 with digital input DI2...DI6. See above.            7 = DI1,2 – Selects one of three Constant Speeds (1...3) using DI1 and DI2.            • Uses two digital inputs, as defined below (0 = DI de-activated, 1 = DI activated):</p> <table border="1"> <thead> <tr> <th>DI1</th> <th>DI2</th> <th>Function</th> </tr> </thead> <tbody> <tr> <td>0</td> <td>0</td> <td>No constant speed</td> </tr> <tr> <td>1</td> <td>0</td> <td>Constant speed 1 (1202)</td> </tr> <tr> <td>0</td> <td>1</td> <td>Constant speed 2 (1203)</td> </tr> <tr> <td>1</td> <td>1</td> <td>Constant speed 3 (1204)</td> </tr> </tbody> </table> <p>• Can be set up as a so-called fault speed, which is activated if the control signal is lost. Refer to parameter 3001 AI&lt;MIN function and parameter 3002 PANEL COMM ERR.            8 = DI2,3 – Selects one of three Constant Speeds (1...3) using DI2 and DI3.            • See above (DI1,2) for code.            9 = DI3,4 – Selects one of three Constant Speeds (1...3) using DI3 and DI4.            • See above (DI1,2) for code.            10 = DI4,5 – Selects one of three Constant Speeds (1...3) using DI4 and DI5.            • See above (DI1,2) for code.            11 = DI5,6 – Selects one of three Constant Speeds (1...3) using DI5 and DI6.            • See above (DI1,2) for code.            12 = DI1,2,3 – Selects one of seven Constant Speeds (1...7) using DI1, DI2 and DI3.            • Uses three digital inputs, as defined below (0 = DI de-activated, 1 = DI activated):</p> <table border="1"> <thead> <tr> <th>DI1</th> <th>DI2</th> <th>DI3</th> <th>Function</th> </tr> </thead> <tbody> <tr> <td>0</td> <td>0</td> <td>0</td> <td>No constant speed</td> </tr> <tr> <td>1</td> <td>0</td> <td>0</td> <td>Constant speed 1 (1202)</td> </tr> <tr> <td>0</td> <td>1</td> <td>0</td> <td>Constant speed 2 (1203)</td> </tr> <tr> <td>1</td> <td>1</td> <td>0</td> <td>Constant speed 3 (1204)</td> </tr> <tr> <td>0</td> <td>0</td> <td>1</td> <td>Constant speed 4 (1205)</td> </tr> <tr> <td>1</td> <td>0</td> <td>1</td> <td>Constant speed 5 (1206)</td> </tr> <tr> <td>0</td> <td>1</td> <td>1</td> <td>Constant speed 6 (1207)</td> </tr> <tr> <td>1</td> <td>1</td> <td>1</td> <td>Constant speed 7 (1208)</td> </tr> </tbody> </table>	DI1	DI2	Function	0	0	No constant speed	1	0	Constant speed 1 (1202)	0	1	Constant speed 2 (1203)	1	1	Constant speed 3 (1204)	DI1	DI2	DI3	Function	0	0	0	No constant speed	1	0	0	Constant speed 1 (1202)	0	1	0	Constant speed 2 (1203)	1	1	0	Constant speed 3 (1204)	0	0	1	Constant speed 4 (1205)	1	0	1	Constant speed 5 (1206)	0	1	1	Constant speed 6 (1207)	1	1	1	Constant speed 7 (1208)
DI1	DI2	Function																																																		
0	0	No constant speed																																																		
1	0	Constant speed 1 (1202)																																																		
0	1	Constant speed 2 (1203)																																																		
1	1	Constant speed 3 (1204)																																																		
DI1	DI2	DI3	Function																																																	
0	0	0	No constant speed																																																	
1	0	0	Constant speed 1 (1202)																																																	
0	1	0	Constant speed 2 (1203)																																																	
1	1	0	Constant speed 3 (1204)																																																	
0	0	1	Constant speed 4 (1205)																																																	
1	0	1	Constant speed 5 (1206)																																																	
0	1	1	Constant speed 6 (1207)																																																	
1	1	1	Constant speed 7 (1208)																																																	



Code	Description																																																			
	<p>13 = DI3,4,5 – Selects one of seven Constant Speeds (1...7) using DI3, DI4 and DI5.                      • See above (DI1,2,3) for code.</p> <p>14 = DI4,5,6 – Selects one of seven Constant Speeds (1...7) using DI4, DI5 and DI6.                      • See above (DI1,2,3) for code.</p> <p>15...18 = TIMED FUNC 1...4 – Selects Constant Speed 1, Constant Speed 2 or the external reference, depending on the state of the Timed Function (1...4) and constant speed mode. See parameter 1209 TIMED MODE SEL and <a href="#">Group 36: TIMED FUNCTIONS</a>.</p> <p>19 = TIMED FUN1&amp;2 – Selects a constant speed or the external reference, depending on the state of Timed Functions 1 &amp; 2 and constant speed mode. See parameter 1209 TIMED MODE SEL and <a href="#">Group 36: TIMED FUNCTIONS</a>.</p> <p>-1 = DI1(INV) – Selects Constant Speed 1 with digital input DI1.                      • Inverse operation: Digital input de-activated = Constant Speed 1 activated.</p> <p>-2...-6 = DI2(INV)...DI6(INV) – Selects Constant Speed 1 with digital input. See above.</p> <p>-7 = DI1,2(INV) – Selects one of three Constant Speeds (1...3) using DI1 and DI2.                      • Inverse operation uses two digital inputs, as defined below (0 = DI de-activated, 1 = DI activated):</p> <table border="1" data-bbox="277 611 686 762"> <thead> <tr> <th>DI1</th> <th>DI2</th> <th>Function</th> </tr> </thead> <tbody> <tr> <td>1</td> <td>1</td> <td>No constant speed</td> </tr> <tr> <td>0</td> <td>1</td> <td>Constant speed 1 (1202)</td> </tr> <tr> <td>1</td> <td>0</td> <td>Constant speed 2 (1203)</td> </tr> <tr> <td>0</td> <td>0</td> <td>Constant speed 3 (1204)</td> </tr> </tbody> </table> <p>-8 = DI2,3(INV) – Selects one of three Constant Speeds (1...3) using DI2 and DI3.                      • See above (DI1,2(INV)) for code.</p> <p>-9 = DI3,4(INV) – Selects one of three Constant Speeds (1...3) using DI3 and DI4.                      • See above (DI1,2(INV)) for code.</p> <p>-10 = DI4,5(INV) – Selects one of three Constant Speeds (1...3) using DI4 and DI5.                      • See above (DI1,2(INV)) for code.</p> <p>-11 = DI5,6(INV) – Selects one of three Constant Speeds (1...3) using DI5 and DI6.                      • See above (DI1,2(INV)) for code.</p> <p>-12 = DI1,2,3(INV) – Selects one of seven Constant Speeds (1...7) using DI1, DI2 and DI3.                      • Inverse operation uses three digital inputs, as defined below (0 = DI de-activated, 1 = DI activated):</p> <table border="1" data-bbox="277 1062 734 1337"> <thead> <tr> <th>DI1</th> <th>DI2</th> <th>DI3</th> <th>Function</th> </tr> </thead> <tbody> <tr> <td>1</td> <td>1</td> <td>1</td> <td>No constant speed</td> </tr> <tr> <td>0</td> <td>1</td> <td>1</td> <td>Constant speed 1 (1202)</td> </tr> <tr> <td>1</td> <td>0</td> <td>1</td> <td>Constant speed 2 (1203)</td> </tr> <tr> <td>0</td> <td>0</td> <td>1</td> <td>Constant speed 3 (1204)</td> </tr> <tr> <td>1</td> <td>1</td> <td>0</td> <td>Constant speed 4 (1205)</td> </tr> <tr> <td>0</td> <td>1</td> <td>0</td> <td>Constant speed 5 (1206)</td> </tr> <tr> <td>1</td> <td>0</td> <td>0</td> <td>Constant speed 6 (1207)</td> </tr> <tr> <td>0</td> <td>0</td> <td>0</td> <td>Constant speed 7 (1208)</td> </tr> </tbody> </table> <p>-13 = DI3,4,5(INV) – Selects one of seven Constant Speeds (1...7) using DI3, DI4 and DI5.                      • See above (DI1,2,3(INV)) for code.</p> <p>-14 = DI4,5,6(INV) – Selects one of seven Constant Speeds (1...7) using DI4, DI5 and DI6.                      • See above (DI1,2,3(INV)) for code.</p>	DI1	DI2	Function	1	1	No constant speed	0	1	Constant speed 1 (1202)	1	0	Constant speed 2 (1203)	0	0	Constant speed 3 (1204)	DI1	DI2	DI3	Function	1	1	1	No constant speed	0	1	1	Constant speed 1 (1202)	1	0	1	Constant speed 2 (1203)	0	0	1	Constant speed 3 (1204)	1	1	0	Constant speed 4 (1205)	0	1	0	Constant speed 5 (1206)	1	0	0	Constant speed 6 (1207)	0	0	0	Constant speed 7 (1208)
DI1	DI2	Function																																																		
1	1	No constant speed																																																		
0	1	Constant speed 1 (1202)																																																		
1	0	Constant speed 2 (1203)																																																		
0	0	Constant speed 3 (1204)																																																		
DI1	DI2	DI3	Function																																																	
1	1	1	No constant speed																																																	
0	1	1	Constant speed 1 (1202)																																																	
1	0	1	Constant speed 2 (1203)																																																	
0	0	1	Constant speed 3 (1204)																																																	
1	1	0	Constant speed 4 (1205)																																																	
0	1	0	Constant speed 5 (1206)																																																	
1	0	0	Constant speed 6 (1207)																																																	
0	0	0	Constant speed 7 (1208)																																																	
1202	<p><b>CONST SPEED 1</b>                      Sets value for Constant Speed 1.                      • The range and units depend on parameter 9904 MOTOR CTRL MODE.                      • Range: 0...30000 rpm when 9904 = 1 (VECTOR:SPEED) or 2 (VECTOR:TORQ).                      • Range: 0...500 Hz when 9904 = 3 (SCALAR:FREQ).</p>																																																			
1203	<p><b>CONST SPEED 2...CONST SPEED 7</b>                      Each sets a value for a Constant Speed. See CONST SPEED 1 above.</p>																																																			
1208	<p>Constant Speed 7 is used also as jogging speed. See parameter 1004 JOGGING SEL.</p>																																																			

Code	Description																																										
1209	<p><b>TIMED MODE SEL</b></p> <p>Defines timed function activated constant speed mode. Timed function can be used to change between the external reference and constant speeds when parameter 1201 CONST SPEED SEL = 15...18 (TIMED FUNC 1...4) or 19 (TIMED FUN1&amp;2).</p> <p>1 = EXT/CS1/2/3</p> <ul style="list-style-type: none"> <li>If parameter 1201 = 15...18 (TIMED FUNC 1...4), selects an external speed when this timed function (1...4) is not active and selects Constant speed 1 when it is active.</li> </ul> <table border="1"> <thead> <tr> <th>TIMED FUNCTION 1...4</th> <th>Function</th> </tr> </thead> <tbody> <tr> <td>0</td> <td>External reference</td> </tr> <tr> <td>1</td> <td>Constant speed 1 (1202)</td> </tr> </tbody> </table> <ul style="list-style-type: none"> <li>If parameter 1201 = 19 (TIMED FUN1&amp;2), selects an external speed when neither timed function is active, selects Constant speed 1 when only Timed function 1 is active, selects Constant speed 2 when only Timed function 2 is active and selects Constant speed 3 when both Timed functions 1 and 2 are active.</li> </ul> <table border="1"> <thead> <tr> <th>TIMED FUNCTION 1</th> <th>TIMED FUNCTION 2</th> <th>Function</th> </tr> </thead> <tbody> <tr> <td>0</td> <td>0</td> <td>External reference</td> </tr> <tr> <td>1</td> <td>0</td> <td>Constant speed 1 (1202)</td> </tr> <tr> <td>0</td> <td>1</td> <td>Constant speed 2 (1203)</td> </tr> <tr> <td>1</td> <td>1</td> <td>Constant speed 3 (1204)</td> </tr> </tbody> </table> <p>2 = CS1/2/3/4</p> <ul style="list-style-type: none"> <li>If parameter 1201 = 15...18 (TIMED FUNC 1...4), selects Constant speed 1 when this timed function (1...4) is not active and selects Constant speed 2 when it is active.</li> </ul> <table border="1"> <thead> <tr> <th>TIMED FUNCTION 1...4</th> <th>Function</th> </tr> </thead> <tbody> <tr> <td>0</td> <td>Constant speed 1 (1202)</td> </tr> <tr> <td>1</td> <td>Constant speed 2 (1203)</td> </tr> </tbody> </table> <ul style="list-style-type: none"> <li>If parameter 1201 = 19 (TIMED FUN1&amp;2), selects Constant speed 1 when neither timed function is active, selects Constant speed 2 when only Timed function 1 is active, selects Constant speed 3 when only Timed function 2 is active and selects Constant speed 4 when both Timed functions 1 and 2 are active.</li> </ul> <table border="1"> <thead> <tr> <th>TIMED FUNCTION 1</th> <th>TIMED FUNCTION 2</th> <th>Function</th> </tr> </thead> <tbody> <tr> <td>0</td> <td>0</td> <td>Constant speed 1 (1202)</td> </tr> <tr> <td>1</td> <td>0</td> <td>Constant speed 2 (1203)</td> </tr> <tr> <td>0</td> <td>1</td> <td>Constant speed 3 (1204)</td> </tr> <tr> <td>1</td> <td>1</td> <td>Constant speed 4 (1205)</td> </tr> </tbody> </table>	TIMED FUNCTION 1...4	Function	0	External reference	1	Constant speed 1 (1202)	TIMED FUNCTION 1	TIMED FUNCTION 2	Function	0	0	External reference	1	0	Constant speed 1 (1202)	0	1	Constant speed 2 (1203)	1	1	Constant speed 3 (1204)	TIMED FUNCTION 1...4	Function	0	Constant speed 1 (1202)	1	Constant speed 2 (1203)	TIMED FUNCTION 1	TIMED FUNCTION 2	Function	0	0	Constant speed 1 (1202)	1	0	Constant speed 2 (1203)	0	1	Constant speed 3 (1204)	1	1	Constant speed 4 (1205)
TIMED FUNCTION 1...4	Function																																										
0	External reference																																										
1	Constant speed 1 (1202)																																										
TIMED FUNCTION 1	TIMED FUNCTION 2	Function																																									
0	0	External reference																																									
1	0	Constant speed 1 (1202)																																									
0	1	Constant speed 2 (1203)																																									
1	1	Constant speed 3 (1204)																																									
TIMED FUNCTION 1...4	Function																																										
0	Constant speed 1 (1202)																																										
1	Constant speed 2 (1203)																																										
TIMED FUNCTION 1	TIMED FUNCTION 2	Function																																									
0	0	Constant speed 1 (1202)																																									
1	0	Constant speed 2 (1203)																																									
0	1	Constant speed 3 (1204)																																									
1	1	Constant speed 4 (1205)																																									

### Group 13: ANALOG INPUTS

This group defines the limits and the filtering for analog inputs.

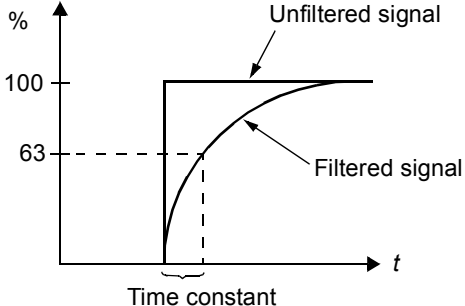
Code	Description
1301	<p><b>MINIMUM AI1</b></p> <p>Defines the minimum value of the analog input.</p> <ul style="list-style-type: none"> <li>Define value as a percent of the full analog signal range. See example below.</li> <li>The minimum analog input signal corresponds to 1104 REF1 MIN or 1107 REF2 MIN.</li> <li>MINIMUM AI cannot be greater than MAXIMUM AI.</li> <li>These parameters (reference and analog min. and max. settings) provide scale and offset adjustment for the reference.</li> <li>See the figure at parameter 1104.</li> </ul> <p><b>Example:</b> To set the minimum analog input value to 4 mA:</p> <ul style="list-style-type: none"> <li>Configure the analog input for 0...20 mA current signal.</li> <li>Calculate the minimum (4 mA) as a percent of full range (20 mA) = <math>4 \text{ mA} / 20 \text{ mA} \cdot 100\% = 20\%</math></li> </ul>
1302	<p><b>MAXIMUM AI1</b></p> <p>Defines the maximum value of the analog input.</p> <ul style="list-style-type: none"> <li>Define value as a percent of the full analog signal range.</li> <li>The maximum analog input signal corresponds to 1105 REF1 MAX or 1108 REF2 MAX.</li> <li>See the figure at parameter 1104.</li> </ul>
1303	<p><b>FILTER AI1</b></p> <p>Defines the filter time constant for analog input 1 (AI1).</p> <ul style="list-style-type: none"> <li>The filtered signal reaches 63% of a step change within the time specified.</li> </ul> 
1304	<p><b>MINIMUM AI2</b></p> <p>Defines the minimum value of the analog input.</p> <ul style="list-style-type: none"> <li>See MINIMUM AI1 above.</li> </ul>
1305	<p><b>MAXIMUM AI2</b></p> <p>Defines the maximum value of the analog input.</p> <ul style="list-style-type: none"> <li>See MAXIMUM AI1 above.</li> </ul>
1306	<p><b>FILTER AI2</b></p> <p>Defines the filter time constant for analog input 2 (AI2).</p> <ul style="list-style-type: none"> <li>See FILTER AI1 above.</li> </ul>

## Group 14: RELAY OUTPUTS

This group defines the condition that activates each of the relay outputs. Relay outputs 4...6 are only available if OREL-01 Relay Output Extension Module is installed.

Code	Description
1401	<p><b>RELAY OUTPUT 1</b></p> <p>Defines the event or condition that activates relay 1 – what relay output 1 means.</p> <p>0 = NOT SEL – Relay is not used and is de-energized.</p> <p>1 = READY – Energize relay when drive is ready to function. Requires:</p> <ul style="list-style-type: none"> <li>• Run enable signal present.</li> <li>• No faults exist.</li> <li>• Supply voltage is within range.</li> <li>• Emergency Stop command is not on.</li> </ul> <p>2 = RUN – Energize relay when the drive is running.</p> <p>3 = FAULT(-1) – Energize relay when power is applied. De-energizes when a fault occurs.</p> <p>4 = FAULT – Energize relay when a fault is active.</p> <p>5 = ALARM – Energize relay when an alarm is active.</p> <p>6 = REVERSED – Energize relay when motor rotates in reverse direction.</p> <p>7 = STARTED – Energize relay when drive receives a start command (even if Run Enable signal is not present). De-energized relay when drive receives a stop command or a fault occurs.</p> <p>8 = SUPRV1 OVER – Energize relay when first supervised parameter (3201) exceeds the limit (3203).</p> <ul style="list-style-type: none"> <li>• See <a href="#">Group 32: SUPERVISION</a> starting on page 153.</li> </ul> <p>9 = SUPRV1 UNDER – Energize relay when first supervised parameter (3201) drops below the limit (3202).</p> <ul style="list-style-type: none"> <li>• See <a href="#">Group 32: SUPERVISION</a> starting on page 153.</li> </ul> <p>10 = SUPRV2 OVER – Energize relay when second supervised parameter (3204) exceeds the limit (3206).</p> <ul style="list-style-type: none"> <li>• See <a href="#">Group 32: SUPERVISION</a> starting on page 153.</li> </ul> <p>11 = SUPRV2 UNDER – Energize relay when second supervised parameter (3204) drops below the limit (3205).</p> <ul style="list-style-type: none"> <li>• See <a href="#">Group 32: SUPERVISION</a> starting on page 153.</li> </ul> <p>12 = SUPRV3 OVER – Energize relay when third supervised parameter (3207) exceeds the limit (3209).</p> <ul style="list-style-type: none"> <li>• See <a href="#">Group 32: SUPERVISION</a> starting on page 153.</li> </ul> <p>13 = SUPRV3 UNDER – Energize relay when third supervised parameter (3207) drops below the limit (3208).</p> <ul style="list-style-type: none"> <li>• See <a href="#">Group 32: SUPERVISION</a> starting on page 153.</li> </ul> <p>14 = AT SET POINT – Energize relay when the output frequency is equal to the reference frequency.</p> <p>15 = FAULT(RST) – Energize relay when the drive is in a fault condition and will reset after the programmed auto-reset delay.</p> <ul style="list-style-type: none"> <li>• See parameter 3103 DELAY TIME.</li> </ul> <p>16 = FLT/ALARM – Energize relay when fault or alarm occurs.</p> <p>17 = EXT CTRL – Energize relay when external control is selected.</p> <p>18 = REF 2 SEL – Energize relay when EXT2 is selected.</p> <p>19 = CONST FREQ – Energize relay when a constant speed is selected.</p> <p>20 = REF LOSS – Energize relay when reference or active control place is lost.</p> <p>21 = OVERCURRENT – Energize relay when an overcurrent alarm or fault occurs.</p> <p>22 = OVERVOLTAGE – Energize relay when an overvoltage alarm or fault occurs.</p> <p>23 = DRIVE TEMP – Energize relay when a drive or control board overtemperature alarm or fault occurs.</p> <p>24 = UNDERVOLTAGE – Energize relay when an undervoltage alarm or fault occurs.</p> <p>25 = AI1 LOSS – Energize relay when AI1 signal is lost.</p> <p>26 = AI2 LOSS – Energize relay when AI2 signal is lost.</p> <p>27 = MOTOR TEMP – Energize relay when a motor overtemperature alarm or fault occurs.</p> <p>28 = STALL – Energize relay when a stall alarm or fault exists.</p> <p>30 = PID SLEEP – Energize relay when the PID sleep function is active.</p> <p>31 = PFC – Use relay to start/stop motor in PFC control (See <a href="#">Group 81: PFC CONTROL</a>).</p> <ul style="list-style-type: none"> <li>• Use this option only when PFC control is used.</li> <li>• Selection activated / deactivated when drive is not running.</li> </ul> <p>32 = AUTOCHANGE – Energize relay when PFC autochange operation is performed.</p> <ul style="list-style-type: none"> <li>• Use this option only when PFC control is used.</li> </ul> <p>33 = FLUX READY – Energize relay when the motor is magnetized and able to supply nominal torque (motor has reached nominal magnetizing).</p> <p>34 = USER MACRO 2 – Energize relay when User Parameter Set 2 is active.</p>

Code	Description																																																																																																																																
	<p>35 = COMM – Energize relay based on input from fieldbus communication.</p> <ul style="list-style-type: none"> <li>Fieldbus writes binary code in parameter 0134 that can energize relay 1...relay 6 according to the following:</li> </ul> <table border="1"> <thead> <tr> <th>Par. 0134</th> <th>Binary</th> <th>RO6</th> <th>RO5</th> <th>RO4</th> <th>RO3</th> <th>RO2</th> <th>RO1</th> </tr> </thead> <tbody> <tr> <td>0</td> <td>000000</td> <td>0</td> <td>0</td> <td>0</td> <td>0</td> <td>0</td> <td>0</td> </tr> <tr> <td>1</td> <td>000001</td> <td>0</td> <td>0</td> <td>0</td> <td>0</td> <td>0</td> <td>1</td> </tr> <tr> <td>2</td> <td>000010</td> <td>0</td> <td>0</td> <td>0</td> <td>0</td> <td>1</td> <td>0</td> </tr> <tr> <td>3</td> <td>000011</td> <td>0</td> <td>0</td> <td>0</td> <td>0</td> <td>1</td> <td>1</td> </tr> <tr> <td>4</td> <td>000100</td> <td>0</td> <td>0</td> <td>0</td> <td>1</td> <td>0</td> <td>0</td> </tr> <tr> <td>5...62</td> <td>...</td> <td>...</td> <td>...</td> <td>...</td> <td>...</td> <td>...</td> <td>...</td> </tr> <tr> <td>63</td> <td>111111</td> <td>1</td> <td>1</td> <td>1</td> <td>1</td> <td>1</td> <td>1</td> </tr> </tbody> </table> <ul style="list-style-type: none"> <li>0 = De-energize relay, 1 = Energize relay.</li> </ul> <p>36 = COMM(-1) – Energize relay based on input from fieldbus communication.</p> <ul style="list-style-type: none"> <li>Fieldbus writes binary code in parameter 0134 that can energize relay 1...relay 6 according to the following:</li> </ul> <table border="1"> <thead> <tr> <th>Par. 0134</th> <th>Binary</th> <th>RO6</th> <th>RO5</th> <th>RO4</th> <th>RO3</th> <th>RO2</th> <th>RO1</th> </tr> </thead> <tbody> <tr> <td>0</td> <td>000000</td> <td>1</td> <td>1</td> <td>1</td> <td>1</td> <td>1</td> <td>1</td> </tr> <tr> <td>1</td> <td>000001</td> <td>1</td> <td>1</td> <td>1</td> <td>1</td> <td>1</td> <td>0</td> </tr> <tr> <td>2</td> <td>000010</td> <td>1</td> <td>1</td> <td>1</td> <td>1</td> <td>0</td> <td>1</td> </tr> <tr> <td>3</td> <td>000011</td> <td>1</td> <td>1</td> <td>1</td> <td>1</td> <td>0</td> <td>0</td> </tr> <tr> <td>4</td> <td>000100</td> <td>1</td> <td>1</td> <td>1</td> <td>0</td> <td>1</td> <td>1</td> </tr> <tr> <td>5...62</td> <td>...</td> <td>...</td> <td>...</td> <td>...</td> <td>...</td> <td>...</td> <td>...</td> </tr> <tr> <td>63</td> <td>111111</td> <td>0</td> <td>0</td> <td>0</td> <td>0</td> <td>0</td> <td>0</td> </tr> </tbody> </table> <ul style="list-style-type: none"> <li>0 = De-energize relay, 1 = Energize relay.</li> </ul> <p>37 = TIMED FUNC 1 – Energize relay when Timed Function 1 is active. See <a href="#">Group 36: TIMED FUNCTIONS</a>.</p> <p>38...40 = TIMED FUNC 2...4 – Energize relay when Timed Function 2...4 is active. See TIMED FUNC 1 above.</p> <p>41 = MNT TRIG FAN – Energize relay when cooling fan counter is triggered. See <a href="#">Group 29: MAINTENANCE TRIG</a>.</p> <p>42 = MNT TRIG REV – Energize relay when revolutions counter is triggered. See <a href="#">Group 29: MAINTENANCE TRIG</a>.</p> <p>43 = MNT TRIG RUN – Energize relay when run time counter is triggered. See <a href="#">Group 29: MAINTENANCE TRIG</a>.</p> <p>44 = MNT TRIG MWH – Energize relay when MWh counter is triggered. See <a href="#">Group 29: MAINTENANCE TRIG</a>.</p> <p>46 = START DELAY – Energize relay when a start delay is active.</p> <p>47 = USER LOAD C – Energize relay when a user load curve fault or alarm occurs.</p> <p>52 = JOG ACTIVE – Energize relay when the jogging function is active.</p>	Par. 0134	Binary	RO6	RO5	RO4	RO3	RO2	RO1	0	000000	0	0	0	0	0	0	1	000001	0	0	0	0	0	1	2	000010	0	0	0	0	1	0	3	000011	0	0	0	0	1	1	4	000100	0	0	0	1	0	0	5...62	...	...	...	...	...	...	...	63	111111	1	1	1	1	1	1	Par. 0134	Binary	RO6	RO5	RO4	RO3	RO2	RO1	0	000000	1	1	1	1	1	1	1	000001	1	1	1	1	1	0	2	000010	1	1	1	1	0	1	3	000011	1	1	1	1	0	0	4	000100	1	1	1	0	1	1	5...62	...	...	...	...	...	...	...	63	111111	0	0	0	0	0	0
Par. 0134	Binary	RO6	RO5	RO4	RO3	RO2	RO1																																																																																																																										
0	000000	0	0	0	0	0	0																																																																																																																										
1	000001	0	0	0	0	0	1																																																																																																																										
2	000010	0	0	0	0	1	0																																																																																																																										
3	000011	0	0	0	0	1	1																																																																																																																										
4	000100	0	0	0	1	0	0																																																																																																																										
5...62	...	...	...	...	...	...	...																																																																																																																										
63	111111	1	1	1	1	1	1																																																																																																																										
Par. 0134	Binary	RO6	RO5	RO4	RO3	RO2	RO1																																																																																																																										
0	000000	1	1	1	1	1	1																																																																																																																										
1	000001	1	1	1	1	1	0																																																																																																																										
2	000010	1	1	1	1	0	1																																																																																																																										
3	000011	1	1	1	1	0	0																																																																																																																										
4	000100	1	1	1	0	1	1																																																																																																																										
5...62	...	...	...	...	...	...	...																																																																																																																										
63	111111	0	0	0	0	0	0																																																																																																																										
1402	<p><b>RELAY OUTPUT 2</b></p> <p>Defines the event or condition that activates relay 2 – what relay output 2 means.</p> <ul style="list-style-type: none"> <li>See 1401 RELAY OUTPUT 1.</li> </ul>																																																																																																																																
1403	<p><b>RELAY OUTPUT 3</b></p> <p>Defines the event or condition that activates relay 3 – what relay output 3 means.</p> <ul style="list-style-type: none"> <li>See 1401 RELAY OUTPUT 1.</li> </ul>																																																																																																																																
1404	<p><b>RO 1 ON DELAY</b></p> <p>Defines the switch-on delay for relay 1.</p> <ul style="list-style-type: none"> <li>On / off delays are ignored when relay output 1401 is set to PFC.</li> </ul>																																																																																																																																
1405	<p><b>RO 1 OFF DELAY</b></p> <p>Defines the switch-off delay for relay 1.</p> <ul style="list-style-type: none"> <li>On / off delays are ignored when relay output 1401 is set to PFC.</li> </ul>																																																																																																																																
1406	<p><b>RO 2 ON DELAY</b></p> <p>Defines the switch-on delay for relay 2.</p> <ul style="list-style-type: none"> <li>See RO 1 ON DELAY.</li> </ul>																																																																																																																																
1407	<p><b>RO 2 OFF DELAY</b></p> <p>Defines the switch-off delay for relay 2.</p> <ul style="list-style-type: none"> <li>See RO 1 OFF DELAY.</li> </ul>																																																																																																																																
1408	<p><b>RO 3 ON DELAY</b></p> <p>Defines the switch-on delay for relay 3.</p> <ul style="list-style-type: none"> <li>See RO 1 ON DELAY.</li> </ul>																																																																																																																																

Code	Description
1409	<b>RO 3 OFF DELAY</b> Switch-off delay for relay 3. • See RO 1 OFF DELAY.
1410 ... 1412	<b>RELAY OUTPUT 4...6</b> Defines the event or condition that activates relay 4...6 – what relay output 4...6 means. Available if OREL-01 Relay Output Extension Module is installed. • See 1401 RELAY OUTPUT 1.
1413	<b>RO 4 ON DELAY</b> Defines the switch-on delay for relay 4. • See RO 1 ON DELAY.
1414	<b>RO 4 OFF DELAY</b> Defines the switch-off delay for relay 4. • See RO 1 OFF DELAY.
1415	<b>RO 5 ON DELAY</b> Defines the switch-on delay for relay 5. • See RO 1 ON DELAY.
1416	<b>RO 5 OFF DELAY</b> Defines the switch-off delay for relay 5. • See RO 1 OFF DELAY.
1417	<b>RO 6 ON DELAY</b> Defines the switch-on delay for relay 6. • See RO 1 ON DELAY.
1418	<b>RO 6 OFF DELAY</b> Defines the switch-off delay for relay 6. • See RO 1 OFF DELAY.

### Group 15: ANALOG OUTPUTS

This group defines the drive's analog (current signal) outputs. The drive's analog outputs can be:

- any parameter in [Group 01: OPERATING DATA](#)
- limited to programmable minimum and maximum values of output current
- scaled (and/or inverted) by defining the minimum and maximum values of the source parameter (or content). Defining an maximum value (parameter 1503 or 1509) that is less than the content minimum value (parameter 1502 or 1508) results in an inverted output.
- filtered.

Code	Description
1501	<p><b>AO1 CONTENT SEL</b>                      Defines the content for analog output AO1.                      99 = EXCITE PTC – Provides a current source for sensor type PTC. Output = 1.6 mA. See <a href="#">Group 35: MOTOR TEMP MEAS</a>.                      100 = EXCITE PT100 – Provides a current source for sensor type PT100. Output = 9.1 mA. See <a href="#">Group 35: MOTOR TEMP MEAS</a>.                      101...178 – Output corresponds to a parameter in <a href="#">Group 01: OPERATING DATA</a>.                      • Parameter defined by value (value 102 = parameter 0102)</p>
1502	<p><b>AO1 CONTENT MIN</b>                      Sets the minimum content value.                      • Content is the parameter selected by parameter 1501.                      • Minimum value refers to the minimum content value that will be converted to an analog output.                      • These parameters (content and current min. and max. settings) provide scale and offset adjustment for the output. See the figure.</p>
1503	<p><b>AO1 CONTENT MAX</b>                      Sets the maximum content value                      • Content is the parameter selected by parameter 1501.                      • Maximum value refers to the maximum content value that will be converted to an analog output.</p>
1504	<p><b>MINIMUM AO1</b>                      Sets the minimum output current.</p>
1505	<p><b>MAXIMUM AO1</b>                      Sets the maximum output current.</p>
1506	<p><b>FILTER AO1</b>                      Defines the filter time constant for AO1.                      • The filtered signal reaches 63% of a step change within the time specified.                      • See the figure in parameter 1303.</p>
1507	<p><b>AO2 CONTENT SEL</b>                      Defines the content for analog output AO2. See AO1 CONTENT SEL above.</p>
1508	<p><b>AO2 CONTENT MIN</b>                      Sets the minimum content value. See AO1 CONTENT MIN above.</p>
1509	<p><b>AO2 CONTENT MAX</b>                      Sets the maximum content value. See AO1 CONTENT MAX above.</p>
1510	<p><b>MINIMUM AO2</b>                      Sets the minimum output current. See MINIMUM AO1 above.</p>

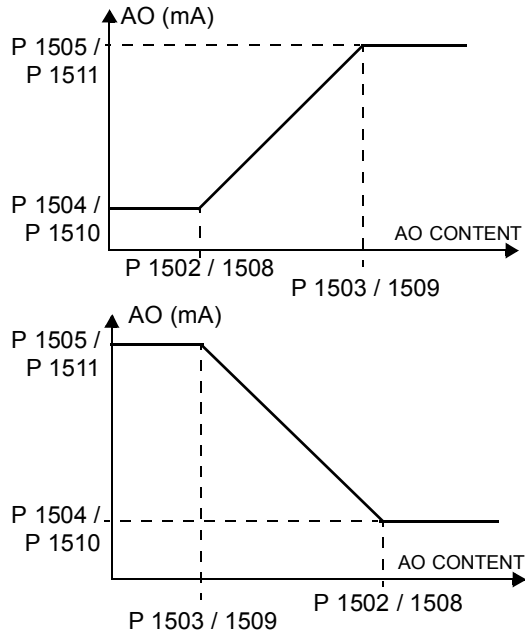

Code	Description
1511	<b>MAXIMUM AO2</b> Sets the maximum output current. See MAXIMUM AO1 above.
1512	<b>FILTER AO2</b> Defines the filter time constant for AO2. See FILTER AO1 above.



**Group 16: SYSTEM CONTROLS**

This group defines a variety of system level locks, resets and enables.

Code	Description
1601	<p><b>RUN ENABLE</b></p> <p>Selects the source of the run enable signal.</p> <p>0 = NOT SEL – Allows the drive to start without an external run enable signal.</p> <p>1 = DI1 – Defines digital input DI1 as the run enable signal.</p> <ul style="list-style-type: none"> <li>This digital input must be activated for run enable.</li> <li>If the voltage drops and de-activates this digital input, the drive will coast to stop and not start until the run enable signal resumes.</li> </ul> <p>2...6 = DI2...DI6 – Defines digital input DI2...DI6 as the run enable signal.</p> <ul style="list-style-type: none"> <li>See DI1 above.</li> </ul> <p>7 = COMM – Assigns the fieldbus Command Word as the source for the run enable signal.</p> <ul style="list-style-type: none"> <li>Bit 6 of the Command Word 1 (parameter 0301) activates the run disable signal.</li> <li>See fieldbus user's manual for detailed instructions.</li> </ul> <p>-1 = DI1(INV) – Defines an inverted digital input DI1 as the run enable signal.</p> <ul style="list-style-type: none"> <li>This digital input must be de-activated for run enable.</li> <li>If this digital input activates, the drive will coast to stop and not start until the run enable signal resumes.</li> </ul> <p>-2...-6 = DI2(INV)...DI6(INV) – Defines an inverted digital input DI2...DI6 as the run enable signal.</p> <ul style="list-style-type: none"> <li>See DI1(INV) above.</li> </ul>
1602	<p><b>PARAMETER LOCK</b></p> <p>Determines if the control panel can change parameter values.</p> <ul style="list-style-type: none"> <li>This lock does not limit parameter changes made by macros.</li> <li>This lock does not limit parameter changes written by fieldbus inputs.</li> <li>This parameter value can be changed only if the correct pass code is entered. See parameter 1603 PASS CODE.</li> </ul> <p>0 = LOCKED – You cannot use the control panel to change parameter values.</p> <ul style="list-style-type: none"> <li>The lock can be opened by entering the valid pass code to parameter 1603.</li> </ul> <p>1 = OPEN – You can use the control panel to change parameter values.</p> <p>2 = NOT SAVED – You can use the control panel to change parameter values, but they are not stored in permanent memory.</p> <ul style="list-style-type: none"> <li>Set parameter 1607 PARAM SAVE to 1 (SAVE) to store changed parameter values to memory.</li> </ul>
1603	<p><b>PASS CODE</b></p> <p>Entering the correct pass code allows you to change the parameter lock.</p> <ul style="list-style-type: none"> <li>See parameter 1602 above.</li> <li>The code 358 allows you to change the value of the parameter 1602 once.</li> <li>This entry reverts back to 0 automatically.</li> </ul>
1604	<p><b>FAULT RESET SEL</b></p> <p>Selects the source for the fault reset signal. The signal resets the drive after a fault trip if the cause of the fault no longer exists.</p> <p>0 = KEYPAD – Defines the control panel as the only fault reset source.</p> <ul style="list-style-type: none"> <li>Fault reset is always possible with control panel.</li> </ul> <p>1 = DI1 – Defines digital input DI1 as a fault reset source.</p> <ul style="list-style-type: none"> <li>Activating the digital input resets the drive.</li> </ul> <p>2...6 = DI2...DI6 – Defines digital input DI2...DI6 as a fault reset source.</p> <ul style="list-style-type: none"> <li>See DI1 above.</li> </ul> <p>7 = START/STOP – Defines the Stop command as a fault reset source.</p> <ul style="list-style-type: none"> <li>Do not use this option when fieldbus communication provides the start, stop and direction commands.</li> </ul> <p>8 = COMM – Defines the fieldbus as a fault reset source.</p> <ul style="list-style-type: none"> <li>The Command Word is supplied through fieldbus communication.</li> <li>The bit 4 of the Command Word 1 (parameter 0301) resets the drive.</li> </ul> <p>-1 = DI1(INV) – Defines an inverted digital input DI1 as a fault reset source.</p> <ul style="list-style-type: none"> <li>De-activating the digital input resets the drive.</li> </ul> <p>-2...-6 = DI2(INV)...DI6(INV) – Defines an inverted digital input DI2...DI6 as a fault reset source.</p> <ul style="list-style-type: none"> <li>See DI1(INV) above.</li> </ul>

Code	Description
1605	<p><b>USER PAR SET CHG</b></p> <p>Defines control for changing the user parameter set.</p> <ul style="list-style-type: none"> <li>• See parameter 9902 APPLIC MACRO.</li> <li>• The drive must be stopped to change User Parameter Sets.</li> <li>• During a change, the drive will not start.</li> </ul> <p><b>Note:</b> Always save the User Parameter Set after changing any parameter settings, or performing a motor identification.</p> <ul style="list-style-type: none"> <li>• Whenever the power is cycled, or parameter 9902 APPLIC MACRO is changed, the drive loads the last settings saved. Any unsaved changes to a user parameter set are lost.</li> </ul> <p><b>Note:</b> The value of this parameter (1605) is not included in the User Parameter Sets, and it does not change if User Parameter Sets change.</p> <p><b>Note:</b> You can use a relay output to supervise the selection of User Parameter Set 2.</p> <ul style="list-style-type: none"> <li>• See parameter 1401.</li> </ul> <p>0 = NOT SEL – Defines the control panel (using parameter 9902) as the only control for changing User Parameter Sets.</p> <p>1 = DI1 – Defines digital input DI1 as a control for changing User Parameter Sets.</p> <ul style="list-style-type: none"> <li>• The drive loads User Parameter Set 1 on the falling edge of the digital input.</li> <li>• The drive loads User Parameter Set 2 on the rising edge of the digital input.</li> <li>• The User Parameter Set changes only when the drive is stopped.</li> </ul> <p>2...6 = DI2...DI6 – Defines digital input DI2...DI6 as a control for changing User Parameter Sets.</p> <ul style="list-style-type: none"> <li>• See DI1 above.</li> </ul> <p>-1 = DI1(INV) – Defines an inverted digital input DI1 as a control for changing User Parameter Sets.</p> <ul style="list-style-type: none"> <li>• The drive loads User Parameter Set 1 on the rising edge of the digital input.</li> <li>• The drive loads User Parameter Set 2 on the falling edge of the digital input.</li> <li>• The User Parameter Set changes only when the drive is stopped.</li> </ul> <p>-2...-6 = DI2(INV)...DI6(INV) – Defines an inverted digital input DI2...DI6 as a control for changing User Parameter Sets.</p> <ul style="list-style-type: none"> <li>• See DI1(INV) above.</li> </ul>
1606	<p><b>LOCAL LOCK</b></p> <p>Defines control for the use of the LOC mode. The LOC mode allows drive control from the control panel.</p> <ul style="list-style-type: none"> <li>• When LOCAL LOCK is active, the control panel cannot change to LOC mode.</li> </ul> <p>0 = NOT SEL – Disables the lock. The control panel can select LOC and control the drive.</p> <p>1 = DI1 – Defines digital input DI1 as the control for setting the local lock.</p> <ul style="list-style-type: none"> <li>• Activating the digital input locks out local control.</li> <li>• De-activating the digital input enable the LOC selection.</li> </ul> <p>2...6 = DI2...DI6 – Defines digital input DI2...DI6 as the control for setting the local lock.</p> <ul style="list-style-type: none"> <li>• See DI1 above.</li> </ul> <p>7 = ON – Sets the lock. The control panel cannot select LOC and cannot control the drive.</p> <p>8 = COMM – Defines bit 14 of the Command Word 1 as the control for setting the local lock.</p> <ul style="list-style-type: none"> <li>• The Command Word is supplied through fieldbus communication.</li> <li>• The Command Word is 0301.</li> </ul> <p>-1 = DI1(INV) – Defines an inverted digital input DI1 as the control for setting the local lock.</p> <ul style="list-style-type: none"> <li>• De-activating the digital input locks out local control.</li> <li>• Activating the digital input enable the LOC selection.</li> </ul> <p>-2...-6 = DI2(INV)...DI6(INV) – Defines an inverted digital input DI2...DI6 as the control for setting the local lock.</p> <ul style="list-style-type: none"> <li>• See DI1(INV) above.</li> </ul>
1607	<p><b>PARAM SAVE</b></p> <p>Saves all altered parameters to permanent memory.</p> <ul style="list-style-type: none"> <li>• Parameters altered through a fieldbus are not automatically saved to permanent memory. To save, you must use this parameter.</li> <li>• If 1602 PARAMETER LOCK = 2 (NOT SAVED), parameters altered from the control panel are not saved. To save, you must use this parameter.</li> <li>• If 1602 PARAMETER LOCK = 1 (OPEN), parameters altered from the control panel are stored immediately to permanent memory.</li> </ul> <p>0 = DONE – Value changes automatically when all parameters are saved.</p> <p>1 = SAVE... – Saves altered parameters to permanent memory.</p>

Code	Description
1608	<p><b>START ENABLE 1</b>                      Selects the source of the start enable 1 signal.</p> <p><b>Note:</b> Start enable functionality differs from the run enable functionality.</p> <p>0 = NOT SEL – Allows the drive to start without an external start enable signal.</p> <p>1 = DI1 – Defines digital input DI1 as the start enable 1 signal.</p> <ul style="list-style-type: none"> <li>This digital input must be activated for start enable 1 signal.</li> <li>If the voltage drops and de-activates this digital input, the drive will coast to stop and show alarm 2021 on the panel display. The drive will not start until start enable 1 signal resumes.</li> </ul> <p>2...6 = DI2...DI6 – Defines digital input DI2...DI6 as the start enable 1 signal.</p> <ul style="list-style-type: none"> <li>See DI1 above.</li> </ul> <p>7 = COMM – Assigns the fieldbus Command Word as the source for the start enable 1 signal.</p> <ul style="list-style-type: none"> <li>Bit 2 of the Command word 2 (parameter 0302) activates the start disable 1 signal.</li> <li>See fieldbus user's manual for detailed instructions.</li> </ul> <p>-1 = DI1(INV) – Defines an inverted digital input DI1 as the start enable 1 signal.</p> <p>-2...-6 = DI2 (INV)...DI6(INV) – Defines an inverted digital input DI2...DI6 as the start enable 1 signal.</p> <ul style="list-style-type: none"> <li>See DI1 (INV) above.</li> </ul>

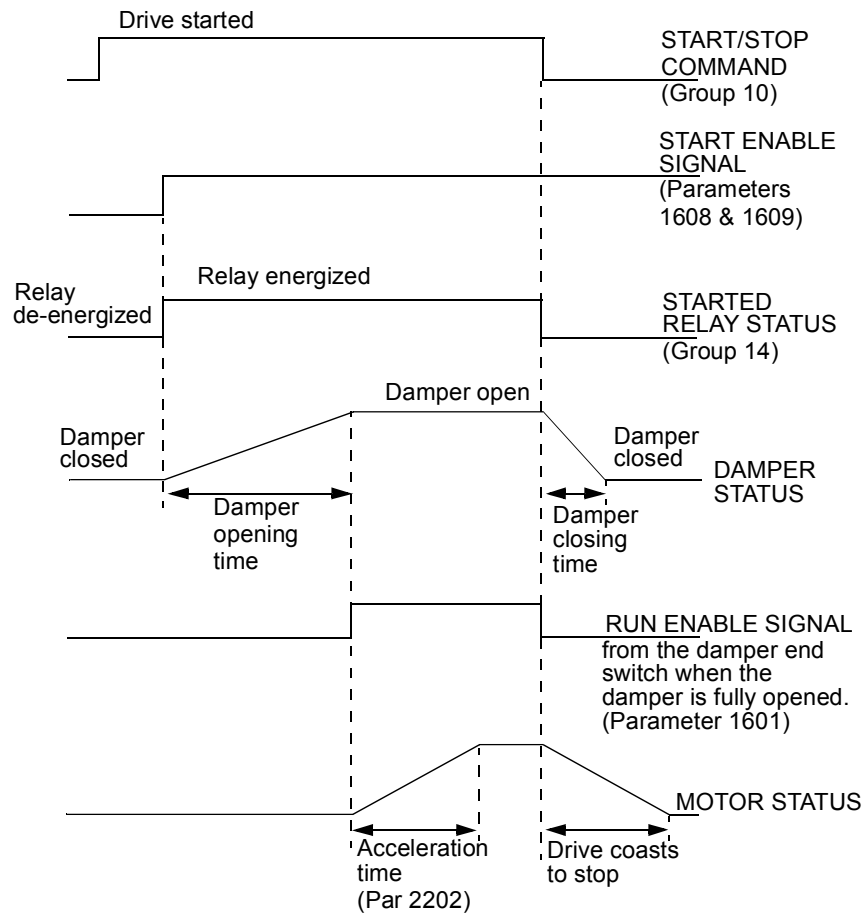

Code	Description
1609	<p><b>START ENABLE 2</b></p> <p>Selects the source of the start enable 2 signal.</p> <p><b>Note:</b> Start enable functionality differs from the run enable functionality.</p> <p>0 = NOT SEL – Allows the drive to start without an external start enable signal.</p> <p>1 = DI1 – Defines digital input DI1 as the start enable 2 signal.</p> <ul style="list-style-type: none"> <li>• This digital input must be activated for start enable 2 signal.</li> <li>• If the voltage drops and de-activates this digital input, the drive will coast to stop and show alarm 2022 on the panel display. The drive will not start until start enable 2 signal resumes.</li> </ul> <p>2...6 = DI2...DI6 – Defines digital input DI2...DI6 as the start enable 2 signal.</p> <ul style="list-style-type: none"> <li>• See DI1 above.</li> </ul> <p>7 = COMM – Assigns the fieldbus Command Word as the source for the start enable 2 signal. Bit 3 of the Command word 2 (parameter 0302) activates the start disable 2 signal.</p> <ul style="list-style-type: none"> <li>• See fieldbus user's manual for detailed instructions.</li> </ul> <p>-1 = DI1(INV) – Defines an inverted digital input DI1 as the start enable 2 signal.</p> <p>-2...-6 = DI2(INV)...DI6(INV) – Defines an inverted digital input DI2...DI6 as the start enable 2 signal.</p> <ul style="list-style-type: none"> <li>• See DI1 (INV) above.</li> </ul>
1610	<p><b>DISPLAY ALARMS</b></p> <p>Controls the visibility of the following alarms:</p> <ul style="list-style-type: none"> <li>• 2001, Overcurrent alarm</li> <li>• 2002, Overvoltage alarm</li> <li>• 2003, Undervoltage alarm</li> <li>• 2009, Device overtemperature alarm.</li> </ul> <p>For more information, see section <a href="#">Alarm listing</a> on page 267.</p> <p>0 = NO – The above alarms are suppressed.</p> <p>1 = YES – All of the above alarms are enabled.</p>
1611	<p><b>PARAMETER VIEW</b></p> <p>Selects the parameter view, i.e. which parameters are shown.</p> <p><b>Note:</b> This parameter is visible only when it is activated by the optional FlashDrop device. FlashDrop is designed for fast copying of parameters to unpowered drives. It allows easy customization of the parameter list, e.g. selected parameters can be hidden. For more information, see <i>MFDT-01 FlashDrop User's Manual (3AFE68591074 [English])</i>.</p> <p>FlashDrop parameter values are activated by setting parameter 9902 to 31 (LOAD FD SET).</p> <p>0 = DEFAULT – Complete long and short parameter lists are shown.</p> <p>1 = FLASHDROP – FlashDrop parameter list is shown. Does not include short parameter list. Parameters that are hidden by the FlashDrop device are not visible.</p>
1612	<p><b>FAN CONTROL</b></p> <p>Selects drive cooling fan control. Can be used to mitigate DC voltage fluctuations.</p> <p>0 = AUTO – Fan is controlled automatically (default).</p> <p>1 = ON – Fan is always forced on.</p>
1613	<p><b>FAULT RESET</b></p> <p>Allows to reset faults with a parameter. Can be used to reset faults from remote monitoring systems that have access to drive parameters.</p> <p>0 = DEFAULT – Fault is not reset (default)</p> <p>1 = RESET NOW – Resets fault.</p>

**Group 20: LIMITS**

This group defines minimum and maximum limits to follow in driving the motor – speed, frequency, current, torque, etc.

Code	Description
2001	<p><b>MINIMUM SPEED</b>                      Defines the minimum speed (rpm) allowed.</p> <ul style="list-style-type: none"> <li>• A positive (or zero) minimum speed value defines two ranges, one positive and one negative.</li> <li>• A negative minimum speed value defines one speed range.</li> <li>• See the figure.</li> </ul>
2002	<p><b>MAXIMUM SPEED</b>                      Defines the maximum speed (rpm) allowed.</p>
2003	<p><b>MAX CURRENT</b>                      Defines the maximum output current (A) supplied by the drive to the motor.</p>
2005	<p><b>OVERVOLT CTRL</b>                      Sets the DC overvoltage controller on or off.</p> <ul style="list-style-type: none"> <li>• Fast braking of a high inertia load causes the DC bus voltage to rise to the overvoltage control limit. To prevent the DC voltage from exceeding the trip limit, the overvoltage controller automatically decreases the braking torque by increasing output frequency.</li> </ul> <p>0 = DISABLE – Disables controller.                      1 = ENABLE – Enables controller</p> <p><b>Note:</b> If a braking chopper or a braking resistor is connected to the drive, this parameter value must be set to 0 (DISABLE) to ensure proper operation of the chopper.</p>
2006	<p><b>UNDERVOLT CTRL</b>                      Sets the DC undervoltage controller on or off. When on:</p> <ul style="list-style-type: none"> <li>• If the DC bus voltage drops due to loss of input power, the undervoltage controller decreases the motor speed in order to keep the DC bus voltage above the lower limit.</li> <li>• When the motor speed decreases, the inertia of the load causes regeneration back into the drive, keeping the DC bus charged and preventing an undervoltage trip.</li> <li>• The DC undervoltage controller increases power loss ride-through on systems with a high inertia, such as a centrifuge or a fan.</li> </ul> <p>0 = DISABLE – Disables controller.                      1 = ENABLE(TIME) – Enables controller with 500 ms time limit for operation.                      2 = ENABLE – Enables controller without maximum time limit for operation.</p>

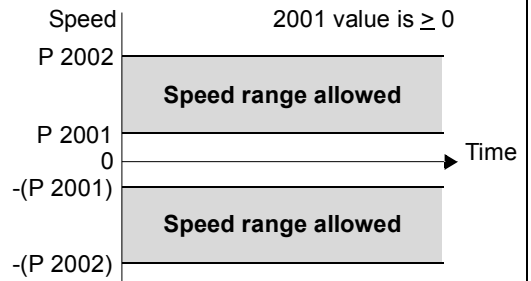
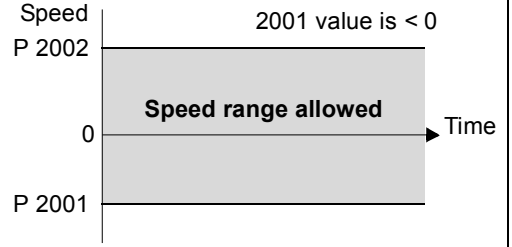

Code	Description
2007	<p><b>MINIMUM FREQ</b></p> <p>Defines the minimum limit for the drive output frequency.</p> <ul style="list-style-type: none"> <li>• A positive or zero minimum frequency value defines two ranges, one positive and one negative.</li> <li>• A negative minimum frequency value defines one speed range.</li> </ul> <p>See the figure.</p> <p><b>Note:</b> Keep <math>\text{MINIMUM FREQ} \leq \text{MAXIMUM FREQ}</math>.</p>
2008	<p><b>MAXIMUM FREQ</b></p> <p>Defines the maximum limit for the drive output frequency.</p>
	<p>The figure consists of two separate graphs. The top graph is titled '2007 value is &lt; 0'. The vertical axis is labeled 'Freq' and has points P 2008 and 0. A shaded horizontal bar labeled 'Frequency range allowed' spans from P 2008 down to 0. The horizontal axis is labeled 'Time' with an arrow pointing right. The bottom graph is titled '2007 value is ≥ 0'. The vertical axis is labeled 'Freq' and has points P 2008, P 2007, 0, -(P 2007), and -(P 2008). Two shaded horizontal bars labeled 'Frequency range allowed' are shown: one between P 2008 and P 2007, and another between -(P 2007) and -(P 2008). The horizontal axis is labeled 'Time' with an arrow pointing right.</p>
2013	<p><b>MIN TORQUE SEL</b></p> <p>Defines control of the selection between two minimum torque limits (2015 MIN TORQUE 1 and 2016 MIN TORQUE 2).</p> <p>0 = MIN TORQUE 1 – Selects 2015 MIN TORQUE 1 as the minimum limit used.</p> <p>1 = DI1 – Defines digital input DI1 as the control for selecting the minimum limit used.</p> <ul style="list-style-type: none"> <li>• Activating the digital input selects MIN TORQUE 2 value.</li> <li>• De-activating the digital input selects MIN TORQUE 1 value.</li> </ul> <p>2...6 = DI2...DI6 – Defines digital input DI2...DI6 as the control for selecting the minimum limit used.</p> <ul style="list-style-type: none"> <li>• See DI1 above.</li> </ul> <p>7 = COMM – Defines bit 15 of the Command Word 1 as the control for selecting the minimum limit used.</p> <ul style="list-style-type: none"> <li>• The Command Word is supplied through fieldbus communication.</li> <li>• The Command Word is parameter 0301.</li> </ul> <p>-1 = DI1(INV) – Defines an inverted digital input DI1 as the control for selecting the minimum limit used.</p> <ul style="list-style-type: none"> <li>• Activating the digital input selects MIN TORQUE 1 value.</li> <li>• De-activating the digital input selects MIN TORQUE 2 value.</li> </ul> <p>-2...-6 = DI2(INV)...DI6(INV) – Defines an inverted digital input DI2...DI6 as the control for selecting the minimum limit used.</p> <ul style="list-style-type: none"> <li>• See DI1(INV) above.</li> </ul>
2014	<p><b>MAX TORQUE SEL</b></p> <p>Defines control of the selection between two maximum torque limits (2017 MAX TORQUE 1 and 2018 MAX TORQUE 2).</p> <p>0 = MAX TORQUE 1 – Selects 2017 MAX TORQUE 1 as the maximum limit used.</p> <p>1 = DI1 – Defines digital input DI1 as the control for selecting the maximum limit used.</p> <ul style="list-style-type: none"> <li>• Activating the digital input selects MAX TORQUE 2 value.</li> <li>• De-activating the digital input selects MAX TORQUE 1 value.</li> </ul> <p>2...6 = DI2...DI6 – Defines digital input DI2...DI6 as the control for selecting the maximum limit used.</p> <ul style="list-style-type: none"> <li>• See DI1 above.</li> </ul> <p>7 = COMM – Defines bit 15 of the Command Word 1 as the control for selecting the maximum limit used.</p> <ul style="list-style-type: none"> <li>• The Command Word is supplied through fieldbus communication.</li> <li>• The Command Word is parameter 0301.</li> </ul> <p>-1 = DI1(INV) – Defines an inverted digital input di1 as the control for selecting the maximum limit used.</p> <ul style="list-style-type: none"> <li>• Activating the digital input selects MAX TORQUE 1 value.</li> <li>• De-activating the digital input selects MAX TORQUE 2 value.</li> </ul> <p>-2...-6 = DI2(INV)...DI6(INV) – Defines an inverted digital input DI2...DI6 as the control for selecting the maximum limit used.</p> <ul style="list-style-type: none"> <li>• See DI1(INV) above.</li> </ul>
2015	<p><b>MIN TORQUE 1</b></p> <p>Sets the first minimum limit for torque (%). Value is a percent of the motor nominal torque.</p>
2016	<p><b>MIN TORQUE 2</b></p> <p>Sets the second minimum limit for torque (%). Value is a percent of the motor nominal torque.</p>

Code	Description
2017	<b>MAX TORQUE 1</b> Sets the first maximum limit for torque (%). Value is a percent of the motor nominal torque.
2018	<b>MAX TORQUE 2</b> Sets the second maximum limit for torque (%). Value is a percent of the motor nominal torque.

## Group 21: START/STOP

This group defines how the motor starts and stops. The ACS550 supports several start and stop modes.

Code	Description
2101	<p><b>START FUNCTION</b></p> <p>Selects the motor start method. The valid options depend on the value of parameter 9904 MOTOR CTRL MODE.</p> <p>1 = AUTO – Selects the automatic start mode.</p> <ul style="list-style-type: none"> <li>• Vector control modes: Optimal start in most cases. The drive automatically selects the correct output frequency to start a rotating motor.</li> <li>• SCALAR:FREQ mode: Immediate start from zero frequency. Identical to selection 8 = RAMP.</li> </ul> <p>2 = DC MAGN – Selects the DC Magnetizing start mode.</p> <p><b>Note:</b> The DC Magnetizing start mode cannot start a rotating motor.</p> <p><b>Note:</b> The drive starts when the set pre-magnetizing time (parameter 2103 DC MAGN TIME) has passed, even if motor magnetization is not complete.</p> <ul style="list-style-type: none"> <li>• Vector control modes: Magnetizes the motor within the time determined by the parameter 2103 DC MAGN TIME using DC current. The normal control is released exactly after the magnetizing time. This selection guarantees the highest possible break-away torque.</li> <li>• SCALAR:FREQ mode: Magnetizes the motor within the time determined by the parameter 2103 DC MAGN TIME using DC current. The normal control is released exactly after the magnetizing time.</li> </ul> <p>3 = SCALAR FLYST – Selects the flying start mode.</p> <ul style="list-style-type: none"> <li>• Vector control modes: Not applicable.</li> <li>• SCALAR:FREQ mode: The drive automatically selects the correct output frequency to start a rotating motor – useful if the motor is already rotating and if the drive will start smoothly at the current frequency.</li> <li>• Cannot be used in multimotor systems.</li> </ul> <p>4 = TORQ BOOST – Selects the automatic torque boost mode (SCALAR:FREQ mode only).</p> <ul style="list-style-type: none"> <li>• May be necessary in drives with high starting torque.</li> <li>• Torque boost is only applied at start, ending when output frequency exceeds 20 Hz or when output frequency is equal to reference.</li> <li>• In the beginning the motor magnetizes within the time determined by the parameter 2103 DC MAGN TIME using DC current.</li> <li>• See parameter 2110 TORQ BOOST CURR.</li> </ul> <p>5 = FLY + BOOST – Selects both the flying start and the torque boost mode (SCALAR:FREQ mode only).</p> <ul style="list-style-type: none"> <li>• Flying start routine is performed first and the motor is magnetized. If the speed is found to be zero, the torque boost is done.</li> </ul> <p>8 = RAMP – Immediate start from zero frequency.</p>
2102	<p><b>STOP FUNCTION</b></p> <p>Selects the motor stop method.</p> <p>1 = COAST – Selects cutting off the motor power as the stop method. The motor coasts to stop.</p> <p>2 = RAMP – Selects using a deceleration ramp.</p> <ul style="list-style-type: none"> <li>• Deceleration ramp is defined by 2203 DECELER TIME 1 or 2206 DECELER TIME 2 (whichever is active).</li> </ul>
2103	<p><b>DC MAGN TIME</b></p> <p>Defines the pre-magnetizing time for the DC Magnetizing start mode.</p> <ul style="list-style-type: none"> <li>• Use parameter 2101 to select the start mode.</li> <li>• After the start command, the drive pre-magnetizes the motor for the time defined here and then starts the motor.</li> <li>• Set the pre-magnetizing time just long enough to allow full motor magnetization. Too long a time heats the motor excessively.</li> </ul>
2104	<p><b>DC HOLD CTL</b></p> <p>Selects whether DC current is used for braking or DC Hold.</p> <p>0 = NOT SEL – Disables the DC current operation.</p> <p>1 = DC HOLD – Enables the DC Hold function. See the diagram.</p> <ul style="list-style-type: none"> <li>• Requires parameter 9904 MOTOR CTRL MODE = 1 (VECTOR:SPEED)</li> <li>• Stops generating sinusoidal current and injects DC into the motor when both the reference and the motor speed drop below the value of parameter 2105.</li> <li>• When the reference rises above the level of parameter 2105 the drive resumes normal operation.</li> </ul> <p>2 = DC BRAKING – Enables the DC Injection Braking after modulation has stopped.</p> <ul style="list-style-type: none"> <li>• If parameter 2102 STOP FUNCTION is 1 (COAST), braking is applied after start is removed.</li> <li>• If parameter 2102 STOP FUNCTION is 2 (RAMP), braking is applied after ramp.</li> </ul>

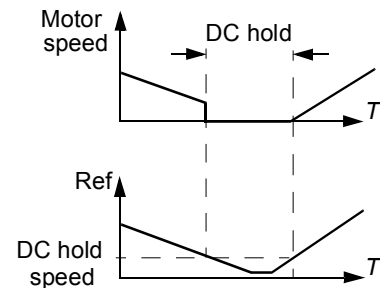

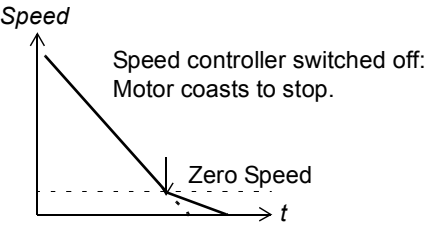
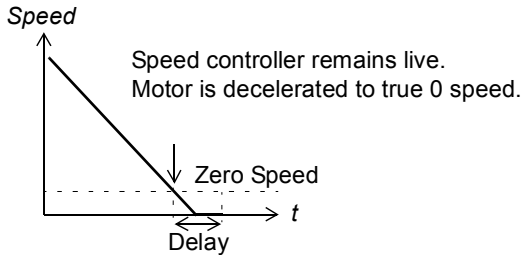

Code	Description
2105	<p><b>DC HOLD SPEED</b></p> <p>Sets the speed for DC Hold. Requires that parameter 2104 DC HOLD CTL = 1 (DC HOLD).</p>
2106	<p><b>DC CURR REF</b></p> <p>Defines the DC current control reference as a percentage of parameter 9906 MOTOR NOM CURR.</p>
2107	<p><b>DC BRAKE TIME</b></p> <p>Defines the DC brake time after modulation has stopped, if parameter 2104 is 2 (DC BRAKING).</p>
2108	<p><b>START INHIBIT</b></p> <p>Sets the Start inhibit function on or off. If the drive is not actively started and running, the Start inhibit function ignores a pending start command in any of the following situations and a new start command is required:</p> <ul style="list-style-type: none"> <li>• A fault is reset.</li> <li>• Run Enable (parameter 1601) activates while start command is active.</li> <li>• Mode changes from local to remote.</li> <li>• Control switches from EXT1 to EXT2.</li> <li>• Control switches from EXT2 to EXT1.</li> </ul> <p>0 = OFF – Disables the Start inhibit function. 1 = ON – Enables the Start inhibit function.</p>
2109	<p><b>EMERG STOP SEL</b></p> <p>Defines control of the Emergency stop command. When activated:</p> <ul style="list-style-type: none"> <li>• Emergency stop decelerates the motor using the emergency stop ramp (parameter 2208 EMERG DEC TIME).</li> <li>• Requires an external stop command and removal of the emergency stop command before drive can restart.</li> </ul> <p>0 = NOT SEL – Disables the Emergency stop function through digital inputs. 1 = DI1 – Defines digital input DI1 as the control for Emergency stop command.</p> <ul style="list-style-type: none"> <li>• Activating the digital input issues an Emergency stop command.</li> <li>• De-activating the digital input removes the Emergency stop command.</li> </ul> <p>2...6 = DI2...DI6 – Defines digital input DI2...DI6 as the control for Emergency stop command.</p> <ul style="list-style-type: none"> <li>• See DI1 above.</li> </ul> <p>-1 = DI1(INV) – Defines an inverted digital input DI1 as the control for Emergency stop command.</p> <ul style="list-style-type: none"> <li>• De-activating the digital input issues an Emergency stop command.</li> <li>• Activating the digital input removes the Emergency stop command.</li> </ul> <p>-2...-6 = DI2(INV)...DI6(INV) – Defines an inverted digital input DI2...DI6 as the control for Emergency stop command.</p> <ul style="list-style-type: none"> <li>• See DI1(INV) above.</li> </ul>
2110	<p><b>TORQ BOOST CURR</b></p> <p>Sets the maximum supplied current during torque boost.</p> <ul style="list-style-type: none"> <li>• See parameter 2101 START FUNCTION.</li> </ul>

Code	Description
2112	<p><b>ZERO SPEED DELAY</b></p> <p>Defines the delay for the Zero Speed Delay function. If parameter value is set to zero, the Zero Speed Delay function is disabled.</p> <p>The function is useful in applications where a smooth and quick restarting is essential. During the delay the drive knows accurately the rotor position.</p> <div style="display: flex; justify-content: space-around;"> <div data-bbox="263 373 694 640"> <p><b>No Zero Speed Delay</b></p>  </div> <div data-bbox="798 373 1324 661"> <p><b>With Zero Speed Delay</b></p>  </div> </div> <p>Zero speed delay can be used e.g. with jogging function or mechanical brake.</p> <p><b>No Zero Speed Delay</b></p> <p>The drive receives a stop command and decelerates along a ramp. When the motor actual speed falls below an internal limit (called Zero Speed), the speed controller is switched off. The drive modulation is stopped and the motor coasts to standstill.</p> <p><b>With Zero Speed Delay</b></p> <p>The drive receives a stop command and decelerates along a ramp. When the motor actual speed falls below an internal limit (called Zero Speed), the zero speed delay function activates. During the delay the functions keeps the speed controller live: The drive modulates, motor is magnetized and drive is ready for a quick restart.</p> <p><b>Note:</b> Parameter 2102 STOP FUNCTION must be 2 = RAMP for zero speed delay to operate. 0.0 = NOT SEL – Disables the Zero Speed Delay function.</p>
2113	<p><b>START DELAY</b></p> <p>Defines the Start delay. After the conditions for start have been fulfilled, the drive waits until the delay has elapsed and then starts the motor. Start delay can be used with all start modes.</p> <ul style="list-style-type: none"> <li>• If START DELAY = zero, the delay is disabled.</li> <li>• During the Start delay, alarm 2028 START DELAY is shown.</li> </ul>

**Group 22: ACCEL/DECEL**

This group defines ramps that control the rate of acceleration and deceleration. You define these ramps as a pair, one for acceleration and one for deceleration. You can define two pairs of ramps and use a digital input to select one or the other pair.

Code	Description
2201	<p><b>ACC/DEC 1/2 SEL</b></p> <p>Defines control for selection of acceleration/deceleration ramps.</p> <ul style="list-style-type: none"> <li>Ramps are defined in pairs, one each for acceleration and deceleration.</li> <li>See below for the ramp definition parameters.</li> </ul> <p>0 = NOT SEL – Disables selection, the first ramp pair is used.</p> <p>1 = DI1 – Defines digital input DI1 as the control for ramp pair selection.</p> <ul style="list-style-type: none"> <li>Activating the digital input selects ramp pair 2.</li> <li>De-activating the digital input selects ramp pair 1.</li> </ul> <p>2...6 = DI2...DI6 – Defines digital input DI2...DI6 as the control for ramp pair selection.</p> <ul style="list-style-type: none"> <li>See DI1 above.</li> </ul> <p>7 = COMM – Defines bit 10 of the Command Word 1 as the control for ramp pair selection.</p> <ul style="list-style-type: none"> <li>The Command Word is supplied through fieldbus communication.</li> <li>The Command Word is parameter 0301.</li> </ul> <p>-1 = DI1(INV) – Defines an inverted digital input DI1 as the control for ramp pair selection.</p> <ul style="list-style-type: none"> <li>De-activating the digital input selects ramp pair 2</li> <li>Activating the digital input selects ramp pair 1.</li> </ul> <p>-2...-6 = DI2(INV)...DI6(INV) – Defines an inverted digital input DI2...DI6 as the control for ramp pair selection.</p> <ul style="list-style-type: none"> <li>See DI1(INV) above.</li> </ul>
2202	<p><b>ACCELER TIME 1</b></p> <p>Sets the acceleration time for zero to maximum frequency for ramp pair 1. See A in the figure.</p> <ul style="list-style-type: none"> <li>Actual acceleration time also depends on 2204 RAMP SHAPE 1.</li> <li>See 2008 MAXIMUM FREQ.</li> </ul>
2203	<p><b>DECELER TIME 1</b></p> <p>Sets the deceleration time for maximum frequency to zero for ramp pair 1.</p> <ul style="list-style-type: none"> <li>Actual deceleration time also depends on 2204 RAMP SHAPE 1.</li> <li>See 2008 MAXIMUM FREQ.</li> </ul>
2204	<p><b>RAMP SHAPE 1</b></p> <p>Selects the shape of the acceleration/deceleration ramp for ramp pair 1. See B in the figure.</p> <ul style="list-style-type: none"> <li>Shape is defined as a ramp, unless additional time is specified here to reach the maximum frequency. A longer time provides a softer transition at each end of the slope. The shape becomes an s-curve.</li> <li>Rule of thumb: 1/5 is a suitable relation between the ramp shape time and the acceleration ramp time.</li> </ul> <p>0.0 = LINEAR – Specifies linear acceleration/deceleration ramps for ramp pair 1.</p> <p>0.1...1000.0 = S-CURVE – Specifies s-curve acceleration/deceleration ramps for ramp pair 1.</p>
2205	<p><b>ACCELER TIME 2</b></p> <p>Sets the acceleration time for zero to maximum frequency for ramp pair 2.</p> <ul style="list-style-type: none"> <li>See 2202 ACCELER TIME 1.</li> <li>Used also as jogging acceleration time. See 1004 JOGGING SEL.</li> </ul>
2206	<p><b>DECELER TIME 2</b></p> <p>Sets the deceleration time for maximum frequency to zero for ramp pair 2.</p> <ul style="list-style-type: none"> <li>See 2203 DECELER TIME 1.</li> <li>Used also as jogging deceleration time. See 1004 JOGGING SEL.</li> </ul>
2207	<p><b>RAMP SHAPE 2</b></p> <p>Selects the shape of the acceleration/deceleration ramp for ramp pair 2.</p> <ul style="list-style-type: none"> <li>See 2204 RAMP SHAPE 1.</li> </ul>

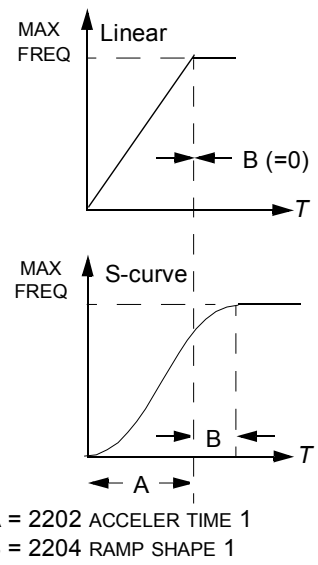

Code	Description
2208	<p><b>EMERG DEC TIME</b></p> <p>Sets the deceleration time for maximum frequency to zero for an emergency.</p> <ul style="list-style-type: none"> <li>• See parameter 2109 EMERG STOP SEL.</li> <li>• Ramp is linear.</li> </ul>
2209	<p><b>RAMP INPUT 0</b></p> <p>Defines control for forcing the speed to 0 with the currently used deceleration ramp (see parameters 2203 DECELER TIME 1 and 2206 DECELER TIME 2).</p> <p>0 = NOT SEL – Not selected.</p> <p>1 = DI1 – Defines digital input DI1 as the control for forcing the speed to 0.</p> <ul style="list-style-type: none"> <li>• Activating the digital input forces the speed to zero, after which the speed will stay at 0.</li> <li>• De-activating the digital input: speed control resumes normal operation.</li> </ul> <p>2...6 = DI2...DI6 – Defines digital input DI2...DI6 as the control for forcing the speed to 0.</p> <ul style="list-style-type: none"> <li>• See DI1 above.</li> </ul> <p>7 = COMM – Defines bit 13 of the Command Word 1 as the control for forcing the speed to 0.</p> <ul style="list-style-type: none"> <li>• The Command Word is supplied through fieldbus communication.</li> <li>• The Command Word is parameter 0301.</li> </ul> <p>-1 = DI1(INV) – Defines inverted digital input DI1 as the control for forcing the speed to 0.</p> <ul style="list-style-type: none"> <li>• De-activating the digital input forces the speed to 0.</li> <li>• Activating the digital input: speed control resumes normal operation.</li> </ul> <p>-2...-6 = DI2(INV)...DI6(INV) – Defines an inverted digital input DI2...DI6 as the control for forcing the speed to 0.</p> <ul style="list-style-type: none"> <li>• See DI1(INV) above.</li> </ul>

### Group 23: SPEED CONTROL

This group defines variables used for speed control operation.

Code	Description
2301	<p><b>PROP GAIN</b></p> <p>Sets the relative gain for the speed controller.</p> <ul style="list-style-type: none"> <li>• Larger values may cause speed oscillation.</li> <li>• The figure shows the speed controller output after an error step (error remains constant).</li> </ul> <p><b>Note:</b> You can use parameter 2305 AUTOTUNE RUN to automatically set the proportional gain.</p>
2302	<p><b>INTEGRATION TIME</b></p> <p>Sets the integration time for the speed controller.</p> <ul style="list-style-type: none"> <li>• The integration time defines the rate at which the controller output changes for a constant error value.</li> <li>• Shorter integration times correct continuous errors faster.</li> <li>• Control becomes unstable if the integration time is too short.</li> <li>• The figure shows the speed controller output after an error step (error remains constant).</li> </ul> <p><b>Note:</b> You can use parameter 2305 AUTOTUNE RUN to automatically set the integration time.</p>
2303	<p><b>DERIVATION TIME</b></p> <p>Sets the derivation time for the speed controller.</p> <ul style="list-style-type: none"> <li>• Derivative action makes the control more responsive to error value changes.</li> <li>• The longer the derivation time, the more the speed controller output is boosted during the change.</li> <li>• If the derivation time is set to zero, the controller works as a PI controller, otherwise as a PID controller.</li> </ul> <p>The figure below shows the speed controller output after an error step when the error remains constant.</p>

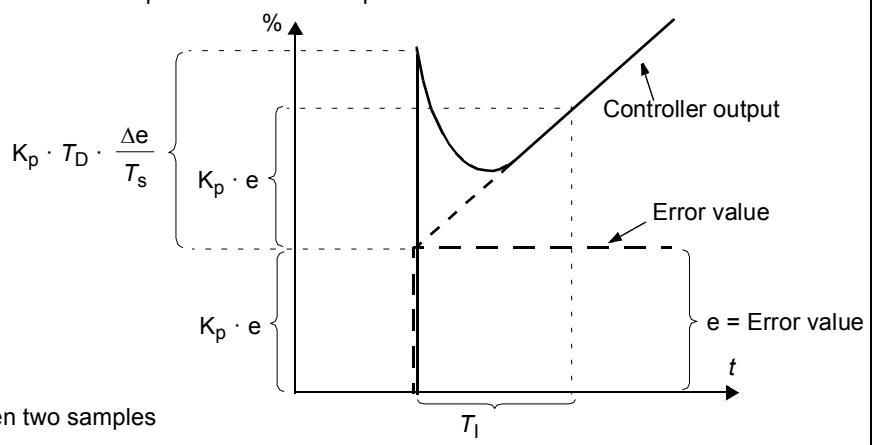
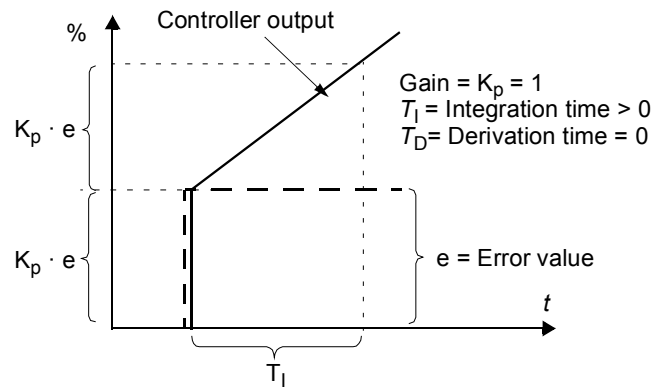
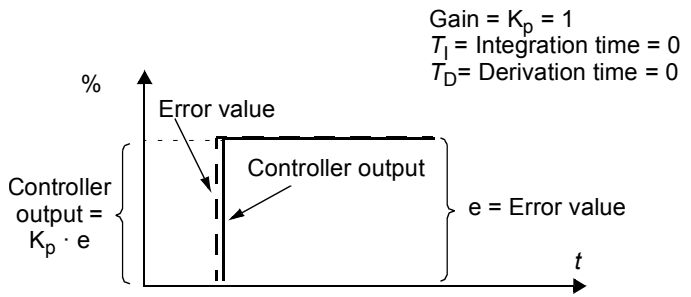

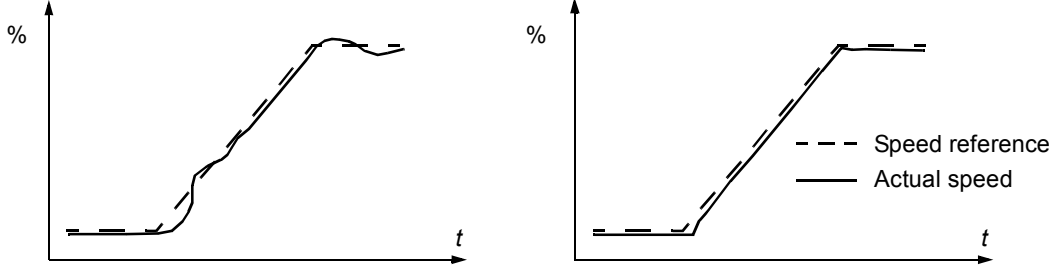
Code	Description
2304	<p><b>ACC COMPENSATION</b></p> <p>Sets the derivation time for acceleration compensation.</p> <ul style="list-style-type: none"> <li>• Adding a derivative of the reference to the output of the speed controller compensates for inertia during acceleration.</li> <li>• 2303 DERIVATION TIME describes the principle of derivative action.</li> <li>• Rule of thumb: Set this parameter between 50 and 100% of the sum of the mechanical time constants for the motor and the driven machine.</li> <li>• The figure shows the speed responses when a high inertia load is accelerated along a ramp.</li> </ul> <p><b>* No acceleration compensation</b>                      <b>Acceleration compensation</b></p>  <p><b>*Note:</b> You can use parameter 2305 AUTOTUNE RUN to automatically set acceleration compensation.</p>
2305	<p><b>AUTOTUNE RUN</b></p> <p>Starts automatic tuning of the speed controller.</p> <p>0 = OFF – Disables the Autotune creation process. (Does not disable the operation of Autotune settings.)</p> <p>1 = ON – Activates speed controller autotuning. Automatically reverts to OFF.</p> <p>Procedure:</p> <p><b>Note:</b> The motor load must be connected.</p> <ul style="list-style-type: none"> <li>• Run the motor at a constant speed of 20 to 40% of the rated speed.</li> <li>• Change the autotuning parameter 2305 to ON.</li> </ul> <p>The drive:</p> <ul style="list-style-type: none"> <li>• Accelerates the motor.</li> <li>• Calculates values for proportional gain, integration time and acceleration compensation.</li> <li>• Changes parameters 2301, 2302 and 2304 to these values.</li> <li>• Resets 2305 to OFF.</li> </ul>

**Group 24: TORQUE CONTROL**

This group defines variables used for torque control operation.

<b>Code</b>	<b>Description</b>
2401	<b>TORQ RAMP UP</b> Defines the torque reference ramp up time – The minimum time for the reference to increase from zero to the nominal motor torque.
2402	<b>TORQ RAMP DOWN</b> Defines the torque reference ramp down time – The minimum time for the reference to decrease from the nominal motor torque to zero.

## Group 25: CRITICAL SPEEDS

This group defines up to three critical speeds or ranges of speeds that are to be avoided due, for example, to mechanical resonance problems at certain speeds.

Code	Description
2501	<p><b>CRIT SPEED SEL</b></p> <p>Sets the critical speeds function on or off. The critical speed function avoids specific speed ranges.</p> <p>0 = OFF – Disables the critical speeds function. 1 = ON – Enables the critical speeds function.</p> <p><b>Example:</b> To avoid speeds at which a fan system vibrates badly:</p> <ul style="list-style-type: none"> <li>• Determine problem speed ranges. Assume they are found to be: 18...23 Hz and 46...52 Hz.</li> <li>• Set 2501 CRIT SPEED SEL = 1.</li> <li>• Set 2502 CRIT SPEED 1 LO = 18 Hz.</li> <li>• Set 2503 CRIT SPEED 1 HI = 23 Hz.</li> <li>• Set 2504 CRIT SPEED 2 LO = 46 Hz.</li> <li>• Set 2505 CRIT SPEED 2 HI = 52 Hz.</li> </ul>
	<p>The graph plots <math>f_{output}</math> on the vertical axis against <math>f_{REF}</math> (Hz) on the horizontal axis. A diagonal line represents the linear relationship. Two critical speed ranges are indicated by dashed boxes with arrows pointing to the corresponding <math>f_{output}</math> values. The first range is between <math>f_{1L}</math> (18 Hz) and <math>f_{1H}</math> (23 Hz), with <math>f_{output}</math> values of 23 Hz and 18 Hz. The second range is between <math>f_{2L}</math> (46 Hz) and <math>f_{2H}</math> (52 Hz), with <math>f_{output}</math> values of 52 Hz and 46 Hz.</p>
2502	<p><b>CRIT SPEED 1 LO</b></p> <p>Sets the minimum limit for critical speed range 1.</p> <ul style="list-style-type: none"> <li>• The value must be less than or equal to 2503 CRIT SPEED 1 HI.</li> <li>• Units are rpm, unless 9904 MOTOR CTRL MODE = 3 (SCALAR:FREQ), then units are Hz.</li> </ul>
2503	<p><b>CRIT SPEED 1 HI</b></p> <p>Sets the maximum limit for critical speed range 1.</p> <ul style="list-style-type: none"> <li>• The value must be greater than or equal to 2502 CRIT SPEED 1 LO.</li> <li>• Units are rpm, unless 9904 MOTOR CTRL MODE = 3 (SCALAR:FREQ), then units are Hz.</li> </ul>
2504	<p><b>CRIT SPEED 2 LO</b></p> <p>Sets the minimum limit for critical speed range 2.</p> <ul style="list-style-type: none"> <li>• See parameter 2502.</li> </ul>
2505	<p><b>CRIT SPEED 2 HI</b></p> <p>Sets the maximum limit for critical speed range 2.</p> <ul style="list-style-type: none"> <li>• See parameter 2503.</li> </ul>
2506	<p><b>CRIT SPEED 3 LO</b></p> <p>Sets the minimum limit for critical speed range 3.</p> <ul style="list-style-type: none"> <li>• See parameter 2502.</li> </ul>
2507	<p><b>CRIT SPEED 3 HI</b></p> <p>Sets the maximum limit for critical speed range 3.</p> <ul style="list-style-type: none"> <li>• See parameter 2503.</li> </ul>



### Group 26: MOTOR CONTROL

This group defines variables used for motor control.

Code	Description																								
2601	<p><b>FLUX OPT ENABLE</b></p> <p>Changes the magnitude of the flux depending on the actual load. Flux Optimization can reduce the total energy consumption and noise, and it should be enabled for drives that usually operate below nominal load.</p> <p>0 = OFF – Disables the feature. 1 = ON – Enables the feature.</p>																								
2602	<p><b>FLUX BRAKING</b></p> <p>Provides faster deceleration by raising the level of magnetization in the motor when needed, instead of limiting the deceleration ramp. By increasing the flux in the motor, the energy of the mechanical system is changed to thermal energy in the motor.</p> <ul style="list-style-type: none"> <li>Requires parameter 9904 MOTOR CTRL MODE = 1 (VECTOR:SPEED) OR 2 (VECTOR:TORQ).</li> </ul> <p>0 = OFF – Disables the feature. 1 = ON – Enables the feature.</p> <div style="display: flex; justify-content: space-between;"> <div style="width: 45%;"> <p>Braking torque (%)</p> </div> <div style="width: 45%;"> <p>Rated motor power</p> <ul style="list-style-type: none"> <li>① 2.2 kW</li> <li>② 15 kW</li> <li>③ 37 kW</li> <li>④ 75 kW</li> <li>⑤ 250 kW</li> </ul> </div> </div>																								
2603	<p><b>IR COMP VOLT</b></p> <p>Sets the IR compensation voltage used for 0 Hz.</p> <ul style="list-style-type: none"> <li>Requires parameter 9904 MOTOR CTRL MODE = 3 (SCALAR:FREQ).</li> <li>Keep IR compensation as low as possible to prevent overheating.</li> <li>Typical IR compensation values are:</li> </ul> <table border="1" style="width: 100%; text-align: center;"> <thead> <tr> <th colspan="6">380...480 V drives</th> </tr> <tr> <th><math>P_N</math> (kW)</th> <td>3</td> <td>7.5</td> <td>15</td> <td>37</td> <td>132</td> </tr> <tr> <th>IR comp (V)</th> <td>18</td> <td>15</td> <td>12</td> <td>8</td> <td>3</td> </tr> </thead> <tbody> <tr> <td></td> <td></td> <td></td> <td></td> <td></td> <td></td> </tr> </tbody> </table> <p>IR compensation</p> <ul style="list-style-type: none"> <li>When enabled, IR compensation provides an extra voltage boost to the motor at low speeds. Use IR compensation, for example, in applications that require a high breakaway torque.</li> </ul> <div style="display: flex; justify-content: space-between;"> <div style="width: 45%;"> <p>Motor voltage</p> </div> <div style="width: 45%;"> <p>A = IR compensated B = No compensation</p> </div> </div>	380...480 V drives						$P_N$ (kW)	3	7.5	15	37	132	IR comp (V)	18	15	12	8	3						
380...480 V drives																									
$P_N$ (kW)	3	7.5	15	37	132																				
IR comp (V)	18	15	12	8	3																				
2604	<p><b>IR COMP FREQ</b></p> <p>Sets the frequency at which IR compensation is 0 V (in % of motor frequency).</p>																								
2605	<p><b>U/F RATIO</b></p> <p>Selects the form for the <math>U/f</math> (voltage to frequency) ratio below field weakening point.</p> <p>1 = LINEAR – Preferred for constant torque applications. 2 = SQUARED – Preferred for centrifugal pump and fan applications. (SQUARED is more silent for most operating frequencies.)</p>																								

Code	Description												
2606	<p><b>SWITCHING FREQ</b></p> <p>Sets the switching frequency for the drive. Also see parameter 2607 SWITCH FREQ CTRL and section <a href="#">Switching frequency derating</a> on page 280.</p> <ul style="list-style-type: none"> <li>Higher switching frequencies mean less noise.</li> <li>In multimotor systems, do not change the switching frequency from the default value.</li> <li>12 kHz switching frequency is available in scalar control mode, that is when parameter 9904 MOTOR CTRL MODE = 3 (SCALAR:FREQ).</li> <li>See the availability of switching frequencies for different drive types in the table below.</li> </ul> <table border="1"> <thead> <tr> <th></th> <th>1, 2, 4 and 8 kHz</th> <th>12 kHz</th> </tr> </thead> <tbody> <tr> <td>208...240 V</td> <td>All types</td> <td>Frame sizes R1...R4 in scalar control mode</td> </tr> <tr> <td>380...480 V</td> <td>All types</td> <td>Frame sizes R1...R4 (except ACS550-01-097A-4) in scalar control mode</td> </tr> <tr> <td>500...600 V</td> <td>All types</td> <td>Frame sizes R2...R4 in scalar control mode</td> </tr> </tbody> </table>		1, 2, 4 and 8 kHz	12 kHz	208...240 V	All types	Frame sizes R1...R4 in scalar control mode	380...480 V	All types	Frame sizes R1...R4 (except ACS550-01-097A-4) in scalar control mode	500...600 V	All types	Frame sizes R2...R4 in scalar control mode
	1, 2, 4 and 8 kHz	12 kHz											
208...240 V	All types	Frame sizes R1...R4 in scalar control mode											
380...480 V	All types	Frame sizes R1...R4 (except ACS550-01-097A-4) in scalar control mode											
500...600 V	All types	Frame sizes R2...R4 in scalar control mode											
2607	<p><b>SWITCH FREQ CTRL</b></p> <p>The switching frequency may be reduced if the ACS550 internal temperature rises above a limit. See the figure. This function allows the highest possible switching frequency to be used based on operating conditions. Higher switching frequency results in lower acoustic noise.</p> <ul style="list-style-type: none"> <li>In multimotor systems, do not disable (set OFF) the function.</li> </ul> <p>0 = OFF – The function is disabled. 1 = ON – The switching frequency is limited according to the figure.</p>												
	<p>The graph plots the switching frequency limit (<math>f_{sw}</math> limit) on the y-axis against Drive temperature (<math>T</math>) on the x-axis. The y-axis has markers at 4 kHz, 8 kHz, and 12 kHz. The x-axis has markers at 80 °C, 90 °C, and 100 °C. A horizontal line at 12 kHz is labeled 'R1...R4 drives, see par 2606'. A line that starts at 12 kHz at 80 °C and decreases linearly to 4 kHz at 100 °C is labeled 'R5...R6 drives, see par 2606'. The x-axis is labeled 'Drive temperature' and 'T'.</p>												
2608	<p><b>SLIP COMP RATIO</b></p> <p>Sets gain for slip compensation (in %).</p> <ul style="list-style-type: none"> <li>A squirrel-cage motor slips under load. Increasing the frequency as the motor torque increases compensates for the slip.</li> <li>Requires parameter 9904 MOTOR CTRL MODE = 3 (SCALAR:FREQ).</li> </ul> <p>0 – No slip compensation. 1...200 – Increasing slip compensation. 100% means full slip compensation.</p>												
2609	<p><b>NOISE SMOOTHING</b></p> <p>This parameter introduces a random component to the switching frequency. Noise smoothing distributes the acoustic motor noise over a range of frequencies instead of a single tonal frequency resulting in lower peak noise intensity. The random component has an average of 0 Hz. It is added to the switching frequency set by parameter 2606 SWITCHING FREQ. This parameter has no effect if parameter 2606 = 12 kHz.</p> <p>0 = DISABLE 1 = ENABLE.</p>												
2619	<p><b>DC STABILIZER</b></p> <p>Enables or disables the DC voltage stabilizer. The DC stabilizer is used in scalar control mode to prevent possible voltage oscillations in the drive DC bus caused by motor load or weak supply network. In case of voltage variation the drive tunes the frequency reference to stabilize the DC bus voltage and therefore the load torque oscillation.</p> <p>0 = DISABLE – Disables DC stabilizer. 1 = ENABLE – Enables DC stabilizer.</p>												
2625	<p><b>OVERMODULATION</b></p> <p>Enables or disables overmodulation. Disabling overmodulation can help in some applications in field weakening area.</p> <p>0 = DISABLE – Disables overmodulation. 1 = ENABLE – Enables overmodulation.</p>												



**Group 29: MAINTENANCE TRIG**

This group contains usage levels and trigger points. When usage reaches the set trigger point, a notice displayed on the control panel signals that maintenance is due.

<b>Code</b>	<b>Description</b>
2901	<p><b>COOLING FAN TRIG</b></p> <p>Sets the trigger point for the drive's cooling fan counter.</p> <ul style="list-style-type: none"> <li>• Value is compared to parameter 2902 value.</li> </ul> <p>0.0 – Disables the trigger.</p>
2902	<p><b>COOLING FAN ACT</b></p> <p>Defines the actual value of the drive's cooling fan counter.</p> <ul style="list-style-type: none"> <li>• When parameter 2901 has been set to a non-zero value, the counter starts.</li> <li>• When the actual value of the counter exceeds the value defined by parameter 2901, a maintenance notice is displayed on the panel.</li> </ul> <p>0.0 – Resets the parameter.</p>
2903	<p><b>REVOLUTION TRIG</b></p> <p>Sets the trigger point for the motor's accumulated revolutions counter.</p> <ul style="list-style-type: none"> <li>• Value is compared to parameter 2904 value.</li> </ul> <p>0 – Disables the trigger.</p>
2904	<p><b>REVOLUTION ACT</b></p> <p>Defines the actual value of the motor's accumulated revolutions counter.</p> <ul style="list-style-type: none"> <li>• When parameter 2903 has been set to a non-zero value, the counter starts.</li> <li>• When the actual value of the counter exceeds the value defined by parameter 2903, a maintenance notice is displayed on the panel.</li> </ul> <p>0 – Resets the parameter.</p>
2905	<p><b>RUN TIME TRIG</b></p> <p>Sets the trigger point for the drive's run time counter.</p> <ul style="list-style-type: none"> <li>• Value is compared to parameter 2906 value.</li> </ul> <p>0.0 – Disables the trigger.</p>
2906	<p><b>RUN TIME ACT</b></p> <p>Defines the actual value of the drive's run time counter.</p> <ul style="list-style-type: none"> <li>• When parameter 2905 has been set to a non-zero value, the counter starts.</li> <li>• When the actual value of the counter exceeds the value defined by parameter 2905, a maintenance notice is displayed on the panel.</li> </ul> <p>0.0 – Resets the parameter.</p>
2907	<p><b>USER MWh TRIG</b></p> <p>Sets the trigger point for the drive's accumulated power consumption (in megawatt hours) counter.</p> <ul style="list-style-type: none"> <li>• Value is compared to parameter 2908 value.</li> </ul> <p>0.0 – Disables the trigger.</p>
2908	<p><b>USER MWh ACT</b></p> <p>Defines the actual value of the drive's accumulated power consumption (in megawatt hours) counter.</p> <ul style="list-style-type: none"> <li>• When parameter 2907 has been set to a non-zero value, the counter starts.</li> <li>• When the actual value of the counter exceeds the value defined by parameter 2907, a maintenance notice is displayed on the panel.</li> </ul> <p>0.0 – Resets the parameter.</p>

## Group 30: FAULT FUNCTIONS

This group defines situations that the drive should recognize as potential faults and defines how the drive should respond if the fault is detected.

Code	Description
3001	<p><b>AI&lt;MIN FUNCTION</b></p> <p>Defines the drive response if the analog input (AI) signal drops below the fault limits and AI is used</p> <ul style="list-style-type: none"> <li>• as the active reference source (<a href="#">Group 11: REFERENCE SELECT</a>)</li> <li>• as the Process or External PID controllers' feedback or setpoint source (<a href="#">Group 40: PROCESS PID SET 1</a>, <a href="#">Group 41: PROCESS PID SET 2</a> or <a href="#">Group 42: EXT / TRIM PID</a>) and the corresponding PID controller is active.</li> </ul> <p>3021 AI1 FAULT LIMIT and 3022 AI2 FAULT LIMIT set the fault limits.</p> <p>0 = NOT SEL – No response.</p> <p>1 = FAULT – Displays a fault (7, AI1 LOSS or 8, AI2 LOSS) and the drive coasts to stop.</p> <p>2 = CONST SP 7 – Displays an alarm (2006, AI1 LOSS or 2007, AI2 LOSS) and sets speed using 1208 CONST SPEED 7.</p> <p>3 = LAST SPEED – Displays an alarm (2006, AI1 LOSS or 2007, AI2 LOSS) and sets speed using the last operating level. This value is the average speed over the last 10 seconds.</p> <p> <b>WARNING!</b> If you select CONST SP 7 or LAST SPEED, make sure that continued operation is safe when the analog input signal is lost.</p>
3002	<p><b>PANEL COMM ERR</b></p> <p>Defines the drive response to a control panel communication error.</p> <p>1 = FAULT – Displays a fault (10, PANEL LOSS) and the drive coasts to stop.</p> <p>2 = CONST SP 7 – Displays an alarm (2008, PANEL LOSS) and sets speed using 1208 CONST SPEED 7.</p> <p>3 = LAST SPEED – Displays an alarm (2008, PANEL LOSS) and sets speed using the last operating level. This value is the average speed over the last 10 seconds.</p> <p><b>Note:</b> When either of the two external control locations are active, and start, stop and/or direction are through the control panel – 1001 EXT1 COMMANDS / 1002 EXT2 COMMANDS = 8 (KEYPAD) – the drive follows speed/frequency reference according to the configuration of the external control locations, instead of the value of the last speed or parameter 1208 CONST SPEED 7.</p> <p> <b>WARNING!</b> If you select CONST SP 7 or LAST SPEED, make sure that continued operation is safe when the control panel communication is lost.</p>
3003	<p><b>EXTERNAL FAULT 1</b></p> <p>Defines the External Fault 1 signal input and the drive response to an external fault.</p> <p>0 = NOT SEL – External fault signal is not used.</p> <p>1 = DI1 – Defines digital input DI1 as the external fault input.</p> <ul style="list-style-type: none"> <li>• Activating the digital input indicates a fault. The drive displays a fault (14, EXT FAULT 1) and the drive coasts to stop.</li> </ul> <p>2...6 = DI2...DI6 – Defines digital input DI2...DI6 as the external fault input.</p> <ul style="list-style-type: none"> <li>• See DI1 above.</li> </ul> <p>-1 = DI1(INV) – Defines an inverted digital input DI1 as the external fault input.</p> <ul style="list-style-type: none"> <li>• De-activating the digital input indicates a fault. The drive displays a fault (14, EXT FAULT 1) and the drive coasts to stop.</li> </ul> <p>-2...-6 = DI2(INV)...DI6(INV) – Defines an inverted digital input DI2...DI6 as the external fault input.</p> <ul style="list-style-type: none"> <li>• See DI1(INV) above.</li> </ul>
3004	<p><b>EXTERNAL FAULT 2</b></p> <p>Defines the External Fault 2 signal input and the drive response to an external fault.</p> <ul style="list-style-type: none"> <li>• See parameter 3003 above.</li> </ul>
3005	<p><b>MOT THERM PROT</b></p> <p>Defines the drive response to motor overheating.</p> <p>0 = NOT SEL – No response and/or motor thermal protection not set up.</p> <p>1 = FAULT – When the calculated motor temperature exceeds 90 °C, displays an alarm (2010, MOTOR TEMP). When the calculated motor temperature exceeds 110 °C, displays a fault (9, MOT OVERTEMP) and the drive coasts to stop.</p> <p>2 = ALARM – When the calculated motor temperature exceeds 90 °C, displays an alarm (2010, MOTOR TEMP).</p>

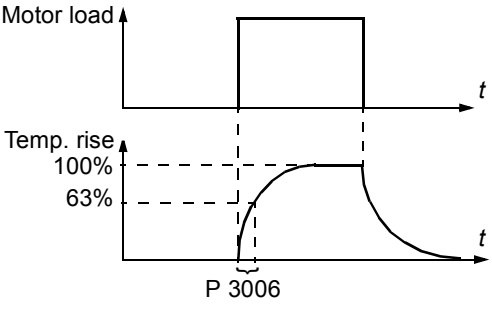
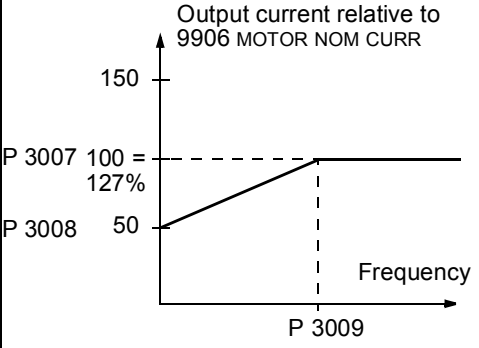
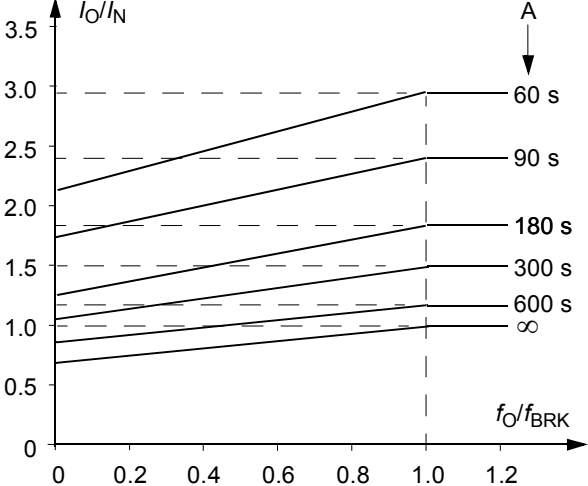
Code	Description	
3006	<p><b>MOT THERM TIME</b></p> <p>Sets the motor thermal time constant for the motor temperature model.</p> <ul style="list-style-type: none"> <li>This is the time required for the motor to reach 63% of the final temperature with steady load.</li> <li>For thermal protection according to UL requirements for NEMA class motors, use the rule of thumb: MOTOR THERM TIME equals 35 times <math>t_6</math>, where <math>t_6</math> (in seconds) is specified by the motor manufacturer as the time that the motor can safely operate at six times its rated current.</li> <li>The thermal time for a Class 10 trip curve is 350 s, for a Class 20 trip curve 700 s, and for a Class 30 trip curve 1050 s.</li> </ul>	
3007	<p><b>MOT LOAD CURVE</b></p> <p>Sets the maximum allowable operating load of the motor.</p> <ul style="list-style-type: none"> <li>With the default value 100%, motor overload protection is functioning when the constant current exceeds 127% of the parameter 9906 MOTOR NOM CURR value.</li> <li>The default overloadability is at the same level as what motor manufacturers typically allow below 30 °C (86 °F) ambient temperature and below 1000 m (3300 ft) altitude. When the ambient temperature exceeds 30 °C (86 °F) or the installation altitude is over 1000 m (3300 ft), decrease the parameter 3007 value according to the motor manufacturer's recommendation.</li> </ul> <p><b>Example:</b> If the constant protection level needs to be 115% of the motor nominal current, set parameter 3007 value to 91% (= 115/127·100%).</p>	
3008	<p><b>ZERO SPEED LOAD</b></p> <p>Sets the maximum allowable current at zero speed.</p> <ul style="list-style-type: none"> <li>Value is relative to 9906 MOTOR NOM CURR.</li> </ul>	
3009	<p><b>BREAK POINT FREQ</b></p> <p>Sets the break point frequency for the motor load curve.</p>	
<p><b>Example:</b> Thermal protection trip times when parameters 3006 MOT THERM TIME, 3007 MOT LOAD CURVE and 3008 ZERO SPEED LOAD have default values.</p>		
 <p> <math>I_O</math> = Output current  <math>I_N</math> = Nominal motor current  <math>f_O</math> = Output frequency  <math>f_{BRK}</math> = Break point frequency  <math>A</math> = Trip time         </p>		

Code	Description
3010	<p><b>STALL FUNCTION</b></p> <p>This parameter defines the operation of the Stall function. This protection is active if the drive operates in the stall region (see the figure) for the time defined by 3012 STALL TIME. The "User Limit" is defined in <a href="#">Group 20: LIMITS</a> by 2017 MAX TORQUE 1, 2018 MAX TORQUE 2, or the limit on the COMM input.</p> <p>0 = NOT SEL – Stall protection is not used.</p> <p>1 = FAULT – When the drive operates in the stall region for the time set by 3012 STALL TIME:</p> <ul style="list-style-type: none"> <li>• The drive coasts to stop.</li> <li>• A fault indication is displayed.</li> </ul> <p>2 = ALARM – When the drive operates in the stall region for the time set by 3012 STALL TIME:</p> <ul style="list-style-type: none"> <li>• An alarm indication is displayed.</li> <li>• The alarm disappears when the drive is out of the stall region for half the time set by parameter 3012 STALL TIME.</li> </ul>
3011	<p><b>STALL FREQUENCY</b></p> <p>This parameter sets the frequency value for the Stall function. Refer to the figure.</p>
3012	<p><b>STALL TIME</b></p> <p>This parameter sets the time value for the Stall function.</p>
3017	<p><b>EARTH FAULT</b></p> <p>Defines the drive response if the drive detects a ground fault in the motor or motor cables. The drive monitors for ground faults while the drive is running, and while the drive is not running. See also parameter 3023 WIRING FAULT and 3028 EARTH FAULT LVL.</p> <p><b>Note:</b> Disabling earth fault (ground fault) may void the warranty.</p> <p>0 = DISABLE – No drive response to ground faults.</p> <p>1 = ENABLE – Ground faults display fault 16 (EARTH FAULT), and (if running) the drive coasts to stop.</p>
3018	<p><b>COMM FAULT FUNC</b></p> <p>Defines the drive response if the fieldbus communication is lost.</p> <p>0 = NOT SEL – No response.</p> <p>1 = FAULT – Displays a fault (28, SERIAL 1 ERR) and the drive coasts to stop.</p> <p>2 = CONST SP 7 – Displays an alarm (2005, I/O COMM) and sets speed using 1208 CONST SPEED 7. This "alarm speed" remains active until the fieldbus writes a new reference value.</p> <p>3 = LAST SPEED – Displays an alarm (2005, I/O COMM) and sets speed using the last operating level. This value is the average speed over the last 10 seconds. This "alarm speed" remains active until the fieldbus writes a new reference value.</p> <p><b>WARNING!</b> If you select CONST SP 7, or LAST SPEED, make sure that continued operation is safe when fieldbus communication is lost.</p>
3019	<p><b>COMM FAULT TIME</b></p> <p>Sets the communication fault time used with 3018 COMM FAULT FUNC.</p> <ul style="list-style-type: none"> <li>• Brief interruptions in the fieldbus communication are not treated as faults if they are less than the COMM FAULT TIME value.</li> </ul>
3021	<p><b>AI1 FAULT LIMIT</b></p> <p>Sets a fault level for analog input 1.</p> <ul style="list-style-type: none"> <li>• See 3001 AI&lt;MIN FUNCTION.</li> </ul>
3022	<p><b>AI2 FAULT LIMIT</b></p> <p>Sets a fault level for analog input 2.</p> <ul style="list-style-type: none"> <li>• See 3001 AI&lt;MIN FUNCTION.</li> </ul>

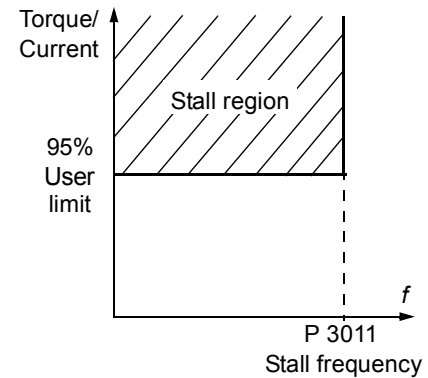

Code	Description
3023	<p><b>WIRING FAULT</b></p> <p>Defines the drive response to cross wiring faults and to ground faults detected when the drive is NOT running. When the drive is not running it monitors for:</p> <ul style="list-style-type: none"> <li>• Improper connections of input power to the drive output (the drive can display fault 35, OUTPUT WIRING if improper connections are detected).</li> <li>• Ground faults (the drive can display fault 16, EARTH FAULT if a ground fault is detected). Also, see parameter 3017 EARTH FAULT.</li> </ul> <p><b>Note:</b> Disabling wiring fault (ground fault) may void the warranty.  0 = DISABLE – No drive response to either of the above monitoring results.  1 = ENABLE – The drive displays faults when this monitoring detects problems.</p>
3024	<p><b>CB TEMP FAULT</b></p> <p>Defines the drive response to control board overheating. Not for drives with an OMIO control board.</p> <p>0 = DISABLE – No response.  1 = ENABLE – Displays fault 37 (CB OVERTEMP) and the drive coasts to stop.</p>
3028	<p><b>EARTH FAULT LVL</b></p> <p>Defines detection level for earth fault. See <a href="#">Correcting faults</a>, fault 16, EARTH FAULT.</p> <p><b>Note:</b> Parameter 3017 EARTH FAULT has to be enabled.</p> <p>1 = LOW – Low level leakage current, high sensitivity. The drive trips to low ground (earth) leakage current (default in the USA software version).  2 = MEDIUM – Medium sensitivity to ground (earth) fault current (default in the European software version).  3 = HIGH – High level leakage current, low sensitivity. The drive trips to higher ground (earth) leakage current.</p>

### Group 31: AUTOMATIC RESET

This group defines conditions for automatic resets. An automatic reset occurs after a particular fault is detected. The drive holds for a set delay time, then automatically restarts. You can limit the number of resets in a specified time period and set up automatic resets for a variety of faults.

Code	Description
3101	<p><b>NUMBER OF TRIALS</b></p> <p>Sets the number of allowed automatic resets within a trial period defined by 3102 TRIAL TIME.</p> <ul style="list-style-type: none"> <li>If the number of automatic resets exceeds this limit (within the trial time), the drive prevents additional automatic resets and remains stopped.</li> <li>Starting then requires a successful reset performed from the control panel or from a source selected by 1604 FAULT RESET SEL.</li> </ul>
3102	<p><b>TRIAL TIME</b></p> <p>Sets the time period used for counting and limiting the number of resets.</p> <ul style="list-style-type: none"> <li>See 3101 NUMBER OF TRIALS.</li> </ul>
3103	<p><b>DELAY TIME</b></p> <p>Sets the delay time between a fault detection and attempted drive restart.</p> <ul style="list-style-type: none"> <li>If DELAY TIME = zero, the drive resets immediately.</li> </ul>
3104	<p><b>AR OVERCURRENT</b></p> <p>Sets the automatic reset for the overcurrent function on or off.</p> <p>0 = DISABLE – Disables automatic reset. 1 = ENABLE – Enables automatic reset.</p> <ul style="list-style-type: none"> <li>Automatically resets the fault (OVERCURRENT) after the delay set by 3103 DELAY TIME, and the drive resumes normal operation.</li> </ul>
3105	<p><b>AR OVERVOLTAGE</b></p> <p>Sets the automatic reset for the overvoltage function on or off.</p> <p>0 = DISABLE – Disables automatic reset. 1 = ENABLE – Enables automatic reset.</p> <ul style="list-style-type: none"> <li>Automatically resets the fault (DC OVERVOLT) after the delay set by 3103 DELAY TIME, and the drive resumes normal operation.</li> </ul>
3106	<p><b>AR UNDERVOLTAGE</b></p> <p>Sets the automatic reset for the undervoltage function on or off.</p> <p>0 = DISABLE – Disables automatic reset. 1 = ENABLE – Enables automatic reset.</p> <ul style="list-style-type: none"> <li>Automatically resets the fault (DC UNDERVOLT) after the delay set by 3103 DELAY TIME, and the drive resumes normal operation.</li> </ul>
3107	<p><b>AR AI&lt;MIN</b></p> <p>Sets the automatic reset for the analog input less than minimum value function on or off.</p> <p>0 = DISABLE – Disables automatic reset. 1 = ENABLE – Enables automatic reset.</p> <ul style="list-style-type: none"> <li>Automatically resets the fault (AI&lt;MIN) after the delay set by 3103 DELAY TIME, and the drive resumes normal operation.</li> </ul> <p> <b>WARNING!</b> When the analog input signal is restored, the drive may restart, even after a long stop. Make sure that automatic, long delayed starts will not cause physical injury and/or damage equipment.</p>
3108	<p><b>AR EXTERNAL FLT</b></p> <p>Sets the automatic reset for external faults function on or off.</p> <p>0 = DISABLE – Disables automatic reset. 1 = ENABLE – Enables automatic reset.</p> <ul style="list-style-type: none"> <li>Automatically resets the fault (EXT FAULT 1 or EXT FAULT 2) after the delay set by 3103 DELAY TIME, and the drive resumes normal operation.</li> </ul>

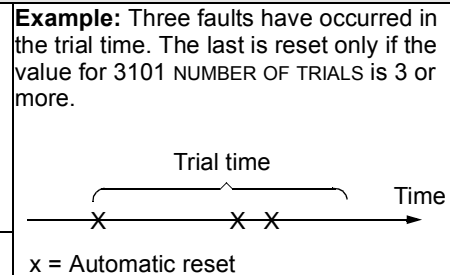



**Group 32: SUPERVISION**

This group defines supervision for up to three signals from *Group 01: OPERATING DATA*. Supervision monitors a specified parameter and energizes a relay output if the parameter passes a defined limit. Use *Group 14: RELAY OUTPUTS* to define the relay and whether the relay activates when the signal is too low or too high.

Code	Description
3201	<p><b>SUPERV 1 PARAM</b></p> <p>Selects the first supervised parameter.</p> <ul style="list-style-type: none"> <li>• Must be a parameter number from <i>Group 01: OPERATING DATA</i>.</li> <li>• 100 = NOT SELECTED – No parameter selected.</li> <li>• 101...178 – Selects parameter 0101...0178.</li> <li>• If the supervised parameter passes a limit, a relay output is energized.</li> <li>• The supervision limits are defined in this group.</li> <li>• The relay outputs are defined in <i>Group 14: RELAY OUTPUTS</i> (definition also specifies which supervision limit is monitored).</li> </ul> <p><b>LO ≤ HI</b></p> <p>Operating data supervision using relay outputs, when LO ≤ HI.</p> <ul style="list-style-type: none"> <li>• Case A = Parameter 1401 RELAY OUTPUT 1 (or 1402 RELAY OUTPUT 2, etc.) value is SUPRV1 OVER or SUPRV2 OVER. Use for monitoring when/if the supervised signal exceeds a given limit. The relay remains active until the supervised value drops below the low limit.</li> <li>• Case B = Parameter 1401 RELAY OUTPUT 1 (or 1402 RELAY OUTPUT 2, etc.) value is SUPRV1 UNDER or SUPRV2 UNDER. Use for monitoring when/if the supervised signal falls below a given limit. The relay remains active until the supervised value rises above the high limit.</li> </ul> <p><b>LO &gt; HI</b></p> <p>Operating data supervision using relay outputs, when LO &gt; HI. The lowest limit (HI 3203) is active initially and remains active until the supervised parameter goes above the highest limit (LO 3202), making that limit the active limit. That limit remains active until the supervised parameter goes below the lowest limit (HI 3203), making that limit active.</p> <ul style="list-style-type: none"> <li>• Case A = Parameter 1401 RELAY OUTPUT 1 (or 1402 RELAY OUTPUT 2, etc.) value is SUPRV1 OVER or SUPRV2 OVER. Initially the relay is de-energized. It is energized whenever the supervised parameter goes above the active limit.</li> <li>• Case B = Parameter 1401 RELAY OUTPUT 1 (or 1402 RELAY OUTPUT 2, etc.) value is SUPRV1 UNDER or SUPRV2 UNDER. Initially the relay is energized. It is de-energized whenever the supervised parameter goes below the active limit.</li> </ul>
3202	<p><b>SUPERV 1 LIM LO</b></p> <p>Sets the low limit for the first supervised parameter. See 3201 SUPERV 1 PARAM above.</p>
3203	<p><b>SUPERV 1 LIM HI</b></p> <p>Sets the high limit for the first supervised parameter. See 3201 SUPERV 1 PARAM above.</p>
3204	<p><b>SUPERV 2 PARAM</b></p> <p>Selects the second supervised parameter. See 3201 SUPERV 1 PARAM above.</p>
3205	<p><b>SUPERV 2 LIM LO</b></p> <p>Sets the low limit for the second supervised parameter. See 3204 SUPERV 2 PARAM above.</p>
3206	<p><b>SUPERV 2 LIM HI</b></p> <p>Sets the high limit for the second supervised parameter. See 3204 SUPERV 2 PARAM above.</p>

**LO ≤ HI**  
**Note:** Case LO ≤ HI represents a normal hysteresis.

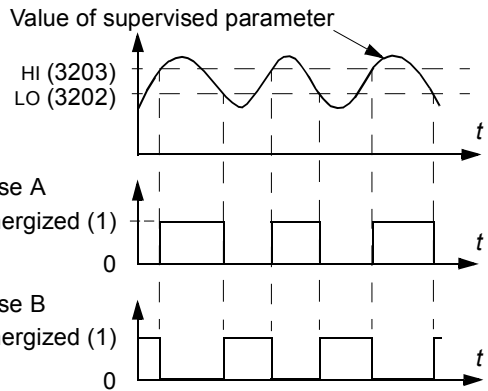

**LO > HI**  
**Note:** Case LO > HI represents a special hysteresis with two separate supervision limits.

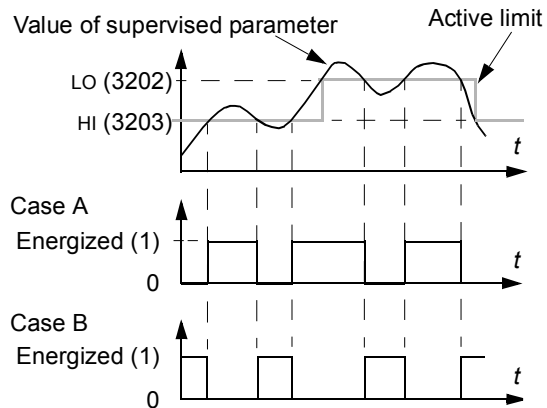

Code	Description
3207	<b>SUPERV 3 PARAM</b> Selects the third supervised parameter. See 3201 SUPERV 1 PARAM above.
3208	<b>SUPERV 3 LIM LO</b> Sets the low limit for the third supervised parameter. See 3207 SUPERV 3 PARAM above.
3209	<b>SUPERV 3 LIM HI</b> Sets the high limit for the third supervised parameter. See 3207 SUPERV 3 PARAM above.

**Group 33: INFORMATION**

This group provides access to information about the drive's current programs: versions and test date.

<b>Code</b>	<b>Description</b>
3301	<b>FIRMWARE</b> Contains the version of the drive's firmware.
3302	<b>LOADING PACKAGE</b> Contains the version of the loading package.
3303	<b>TEST DATE</b> Contains the test date (yy.ww).
3304	<b>DRIVE RATING</b> Indicates the drive's current and voltage rating. The format is XXXY, where: <ul style="list-style-type: none"> <li>• XXX = The nominal current rating of the drive in amperes. If present, an "A" indicates a decimal point in the rating for the current. For example XXX = 8A8 indicates a nominal current rating of 8.8 A.</li> <li>• Y = The voltage rating of the drive, where Y = : <ul style="list-style-type: none"> <li>• 2 indicates a 208...240 V rating.</li> <li>• 4 indicates a 380...480 V rating.</li> <li>• 6 indicates a 500...600 V rating.</li> </ul> </li> </ul>
3305	<b>PARAMETER TABLE</b> Contains the version of the parameter table used in the drive.

### Group 34: PANEL DISPLAY

This group defines the content for control panel display (middle area), when the control panel is in the Output mode.

Code	Description																													
3401	<p><b>SIGNAL1 PARAM</b></p> <p>Selects the first parameter (by number) displayed on the control panel.</p> <ul style="list-style-type: none"> <li>Definitions in this group define display content when the control panel is in the control mode.</li> <li>Any parameter number in <a href="#">Group 01: OPERATING DATA</a> can be selected.</li> <li>Using the following parameters, the display value can be scaled, converted to convenient units and/or displayed as a bar graph.</li> <li>The figure identifies selections made by parameters in this group.</li> <li>If just one or two parameters are selected for display, that is just one or two of the values of parameters 3401 SIGNAL1 PARAM, 3408 SIGNAL2 PARAM and 3415 SIGNAL3 PARAM are other than 100 (NOT SELECTED), the number and name of each displayed parameter are shown in addition to the value.</li> </ul> <p>100 = NOT SELECTED – First parameter not displayed.                      101...178 – Displays parameter 0101...0178. If parameter does not exist, the display shows “n.a.”.</p>																													
3402	<p><b>SIGNAL1 MIN</b></p> <p>Defines the minimum expected value for the first display parameter. Use parameters 3402, 3403, 3406 and 3407, for example to convert a <a href="#">Group 01: OPERATING DATA</a> parameter, such as 0102 SPEED (in rpm) to the speed of a conveyor driven by the motor (in ft/min). For such a conversion, the source values in the figure are the min. and max. motor speed, and the display values are the corresponding min. and max. conveyor speed. Use parameter 3405 to select the proper units for the display.</p> <p><b>Note:</b> Selecting units does not convert values. Parameter is not effective if parameter 3404 OUTPUT1 DSP FORM = 9 (DIRECT).</p>																													
3403	<p><b>SIGNAL1 MAX</b></p> <p>Defines the maximum expected value for the first display parameter.</p> <p><b>Note:</b> Parameter is not effective if parameter 3404 OUTPUT1 DSP FORM = 9 (DIRECT).</p>																													
3404	<p><b>OUTPUT1 DSP FORM</b></p> <p>Defines the decimal point location for the first display parameter. 0...7 – Defines the decimal point location.</p> <ul style="list-style-type: none"> <li>Enter the number of digits desired to the right of the decimal point.</li> <li>See the table for an example using pi (3.14159).</li> </ul> <p>8 = BAR METER – Specifies a bar meter display.                      9 = DIRECT – Decimal point location and units of measure are identical to the source signal. See <a href="#">Group 01: OPERATING DATA</a> parameter listing in section <a href="#">Complete parameter list</a> on page 91 for resolution (which indicates the decimal point location) and the units of measure.</p>	<table border="1"> <thead> <tr> <th>3404 value</th> <th>Display</th> <th>Range</th> </tr> </thead> <tbody> <tr> <td>0</td> <td>± 3</td> <td rowspan="3">-32768...+32767 (Signed)</td> </tr> <tr> <td>1</td> <td>± 3.1</td> </tr> <tr> <td>2</td> <td>± 3.14</td> </tr> <tr> <td>3</td> <td>± 3.142</td> <td rowspan="4">0...65535 (Unsigned)</td> </tr> <tr> <td>4</td> <td>3</td> </tr> <tr> <td>5</td> <td>3.1</td> </tr> <tr> <td>6</td> <td>3.14</td> </tr> <tr> <td>7</td> <td>3.142</td> <td></td> </tr> <tr> <td>8</td> <td colspan="2">Bar meter displayed.</td> </tr> <tr> <td>9</td> <td colspan="2">Decimal point location and units as for the source signal.</td> </tr> </tbody> </table>	3404 value	Display	Range	0	± 3	-32768...+32767 (Signed)	1	± 3.1	2	± 3.14	3	± 3.142	0...65535 (Unsigned)	4	3	5	3.1	6	3.14	7	3.142		8	Bar meter displayed.		9	Decimal point location and units as for the source signal.	
3404 value	Display	Range																												
0	± 3	-32768...+32767 (Signed)																												
1	± 3.1																													
2	± 3.14																													
3	± 3.142	0...65535 (Unsigned)																												
4	3																													
5	3.1																													
6	3.14																													
7	3.142																													
8	Bar meter displayed.																													
9	Decimal point location and units as for the source signal.																													

Code	Description																																																																																				
3405	<p><b>OUTPUT1 UNIT</b> Selects the units used with the first display parameter. <b>Note:</b> Parameter is not effective if parameter 3404 OUTPUT1 DSP FORM = 9 (DIRECT).</p> <table border="0"> <tr> <td>0 = NO UNIT</td> <td>9 = °C</td> <td>18 = MWh</td> <td>27 = ft</td> <td>36 = l/s</td> <td>45 = Pa</td> <td>54 = lb/m</td> <td>63 = Mrev</td> </tr> <tr> <td>1 = A</td> <td>10 = lb ft</td> <td>19 = m/s</td> <td>28 = MGD</td> <td>37 = l/min</td> <td>46 = GPS</td> <td>55 = lb/h</td> <td>64 = d</td> </tr> <tr> <td>2 = V</td> <td>11 = mA</td> <td>20 = m<sup>3</sup>/h</td> <td>29 = inHg</td> <td>38 = l/h</td> <td>47 = gal/s</td> <td>56 = FPS</td> <td>65 = inWC</td> </tr> <tr> <td>3 = Hz</td> <td>12 = mV</td> <td>21 = dm<sup>3</sup>/s</td> <td>30 = FPM</td> <td>39 = m<sup>3</sup>/s</td> <td>48 = gal/m</td> <td>57 = ft/s</td> <td>66 = m/min</td> </tr> <tr> <td>4 = %</td> <td>13 = kW</td> <td>22 = bar</td> <td>31 = kb/s</td> <td>40 = m<sup>3</sup>/m</td> <td>49 = gal/h</td> <td>58 = inH<sub>2</sub>O</td> <td>67 = Nm</td> </tr> <tr> <td>5 = s</td> <td>14 = W</td> <td>23 = kPa</td> <td>32 = kHz</td> <td>41 = kg/s</td> <td>50 = ft<sup>3</sup>/s</td> <td>59 = in wg</td> <td>68 = Km<sup>3</sup>/h</td> </tr> <tr> <td>6 = h</td> <td>15 = kWh</td> <td>24 = GPM</td> <td>33 = ohm</td> <td>42 = kg/m</td> <td>51 = ft<sup>3</sup>/m</td> <td>60 = ft wg</td> <td></td> </tr> <tr> <td>7 = rpm</td> <td>16 = °F</td> <td>25 = PSI</td> <td>34 = ppm</td> <td>43 = kg/h</td> <td>52 = ft<sup>3</sup>/h</td> <td>61 = lbsi</td> <td></td> </tr> <tr> <td>8 = kh</td> <td>17 = hp</td> <td>26 = CFM</td> <td>35 = pps</td> <td>44 = mbar</td> <td>53 = lb/s</td> <td>62 = ms</td> <td></td> </tr> </table> <p>The following units are useful for the bar display.</p> <table border="0"> <tr> <td>117 = %ref</td> <td>119 = %dev</td> <td>121 = % SP</td> <td>123 = Iout</td> <td>125 = Fout</td> <td>127 = Vdc</td> </tr> <tr> <td>118 = %act</td> <td>120 = % LD</td> <td>122 = %FBK</td> <td>124 = Vout</td> <td>126 = Tout</td> <td></td> </tr> </table>	0 = NO UNIT	9 = °C	18 = MWh	27 = ft	36 = l/s	45 = Pa	54 = lb/m	63 = Mrev	1 = A	10 = lb ft	19 = m/s	28 = MGD	37 = l/min	46 = GPS	55 = lb/h	64 = d	2 = V	11 = mA	20 = m <sup>3</sup> /h	29 = inHg	38 = l/h	47 = gal/s	56 = FPS	65 = inWC	3 = Hz	12 = mV	21 = dm <sup>3</sup> /s	30 = FPM	39 = m <sup>3</sup> /s	48 = gal/m	57 = ft/s	66 = m/min	4 = %	13 = kW	22 = bar	31 = kb/s	40 = m <sup>3</sup> /m	49 = gal/h	58 = inH <sub>2</sub> O	67 = Nm	5 = s	14 = W	23 = kPa	32 = kHz	41 = kg/s	50 = ft <sup>3</sup> /s	59 = in wg	68 = Km <sup>3</sup> /h	6 = h	15 = kWh	24 = GPM	33 = ohm	42 = kg/m	51 = ft <sup>3</sup> /m	60 = ft wg		7 = rpm	16 = °F	25 = PSI	34 = ppm	43 = kg/h	52 = ft <sup>3</sup> /h	61 = lbsi		8 = kh	17 = hp	26 = CFM	35 = pps	44 = mbar	53 = lb/s	62 = ms		117 = %ref	119 = %dev	121 = % SP	123 = Iout	125 = Fout	127 = Vdc	118 = %act	120 = % LD	122 = %FBK	124 = Vout	126 = Tout	
0 = NO UNIT	9 = °C	18 = MWh	27 = ft	36 = l/s	45 = Pa	54 = lb/m	63 = Mrev																																																																														
1 = A	10 = lb ft	19 = m/s	28 = MGD	37 = l/min	46 = GPS	55 = lb/h	64 = d																																																																														
2 = V	11 = mA	20 = m <sup>3</sup> /h	29 = inHg	38 = l/h	47 = gal/s	56 = FPS	65 = inWC																																																																														
3 = Hz	12 = mV	21 = dm <sup>3</sup> /s	30 = FPM	39 = m <sup>3</sup> /s	48 = gal/m	57 = ft/s	66 = m/min																																																																														
4 = %	13 = kW	22 = bar	31 = kb/s	40 = m <sup>3</sup> /m	49 = gal/h	58 = inH <sub>2</sub> O	67 = Nm																																																																														
5 = s	14 = W	23 = kPa	32 = kHz	41 = kg/s	50 = ft <sup>3</sup> /s	59 = in wg	68 = Km <sup>3</sup> /h																																																																														
6 = h	15 = kWh	24 = GPM	33 = ohm	42 = kg/m	51 = ft <sup>3</sup> /m	60 = ft wg																																																																															
7 = rpm	16 = °F	25 = PSI	34 = ppm	43 = kg/h	52 = ft <sup>3</sup> /h	61 = lbsi																																																																															
8 = kh	17 = hp	26 = CFM	35 = pps	44 = mbar	53 = lb/s	62 = ms																																																																															
117 = %ref	119 = %dev	121 = % SP	123 = Iout	125 = Fout	127 = Vdc																																																																																
118 = %act	120 = % LD	122 = %FBK	124 = Vout	126 = Tout																																																																																	
3406	<p><b>OUTPUT1 MIN</b> Sets the minimum value displayed for the first display parameter. <b>Note:</b> Parameter is not effective if parameter 3404 OUTPUT1 DSP FORM = 9 (DIRECT).</p>																																																																																				
3407	<p><b>OUTPUT1 MAX</b> Sets the maximum value displayed for the first display parameter. <b>Note:</b> Parameter is not effective if parameter 3404 OUTPUT1 DSP FORM = 9 (DIRECT).</p>																																																																																				
3408	<p><b>SIGNAL2 PARAM</b> Selects the second parameter (by number) displayed on the control panel. See parameter 3401.</p>																																																																																				
3409	<p><b>SIGNAL2 MIN</b> Defines the minimum expected value for the second display parameter. See parameter 3402.</p>																																																																																				
3410	<p><b>SIGNAL2 MAX</b> Defines the maximum expected value for the second display parameter. See parameter 3403.</p>																																																																																				
3411	<p><b>OUTPUT2 DSP FORM</b> Defines the decimal point location for the second display parameter. See parameter 3404.</p>																																																																																				
3412	<p><b>OUTPUT2 UNIT</b> Selects the units used with the second display parameter. See parameter 3405.</p>																																																																																				
3413	<p><b>OUTPUT2 MIN</b> Sets the minimum value displayed for the second display parameter. See parameter 3406.</p>																																																																																				
3414	<p><b>OUTPUT2 MAX</b> Sets the maximum value displayed for the second display parameter. See parameter 3407.</p>																																																																																				
3415	<p><b>SIGNAL3 PARAM</b> Selects the third parameter (by number) displayed on the control panel. See parameter 3401.</p>																																																																																				
3416	<p><b>SIGNAL3 MIN</b> Defines the minimum expected value for the third display parameter. See parameter 3402.</p>																																																																																				
3417	<p><b>SIGNAL3 MAX</b> Defines the maximum expected value for the third display parameter. See parameter 3403.</p>																																																																																				
3418	<p><b>OUTPUT3 DSP FORM</b> Defines the decimal point location for the third display parameter. See parameter 3404.</p>																																																																																				
3419	<p><b>OUTPUT3 UNIT</b> Selects the units used with the third display parameter. See parameter 3405.</p>																																																																																				
3420	<p><b>OUTPUT3 MIN</b> Sets the minimum value displayed for the third display parameter. See parameter 3406.</p>																																																																																				

Code	Description
3421	<b>OUTPUT3 MAX</b> Sets the maximum value displayed for the third display parameter. See parameter 3407.

**Group 35: MOTOR TEMP MEAS**

This group defines the detection and reporting for a particular potential fault – motor overheating, as detected by a temperature sensor. Typical connections are shown below.

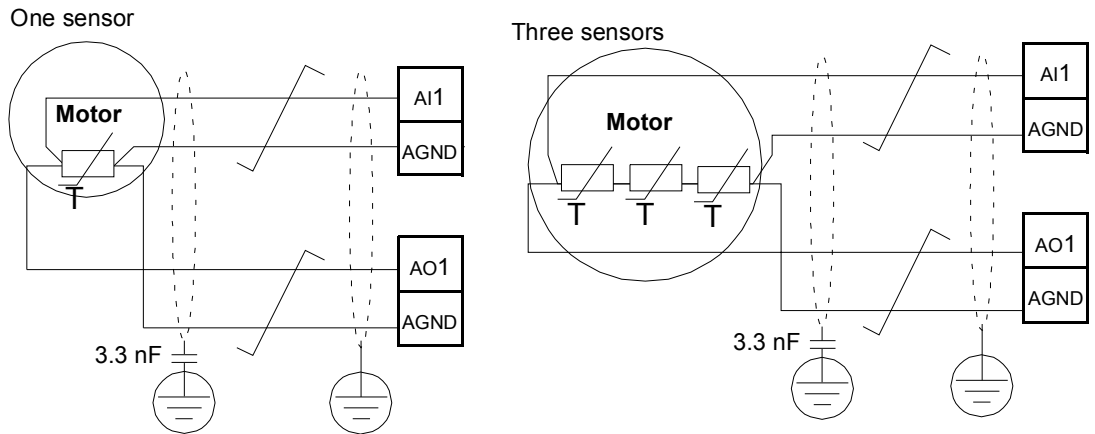

**WARNING!** IEC 60664 requires double or reinforced insulation between live parts and the surface of accessible parts of electrical equipment which are either non-conductive or conductive but not connected to the protective earth.

To fulfil this requirement, connect a thermistor (and other similar components) to the drive's control terminals using any of these alternatives:

- Separate the thermistor from live parts of the motor with double reinforced insulation.
- Protect all circuits connected to the drive's digital and analog inputs. Protect against contact, and insulate from other low voltage circuits with basic insulation (rated for the same voltage level as the drive's main circuit).
- Use an external thermistor relay. The relay insulation must be rated for the same voltage level as the drive's main circuit.

The figure below shows thermistor relay and PTC sensor connections using a digital input. At the motor end, the cable shield should be earthed through, eg a 3.3 nF capacitor. If this is not possible, leave the shield unconnected.

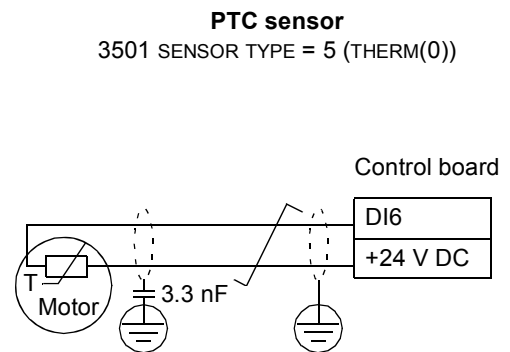
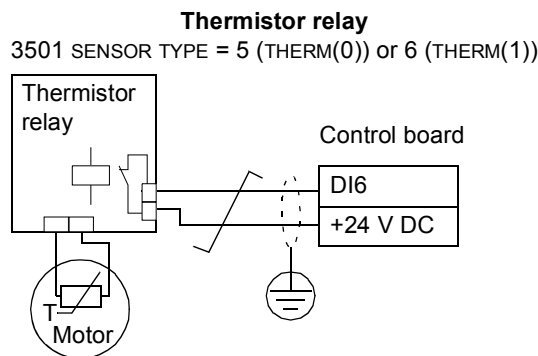

For other faults, or for anticipating motor overheating using a model, see [Group 30: FAULT FUNCTIONS](#).

Code	Description												
3501	<p><b>SENSOR TYPE</b></p> <p>Identifies the type of the motor temperature sensor used, PT100 (°C), PTC (ohm) or thermistor. See parameters 1501 AO1 CONTENT SEL and 1507 AO2 CONTENT SEL.</p> <p>0 = NONE</p> <p>1 = 1 x PT100 – Sensor configuration uses one PT100 sensor.</p> <ul style="list-style-type: none"> <li>Analog output AO1 or AO2 feeds constant current through the sensor.</li> <li>The sensor resistance increases as the motor temperature rises, as does the voltage over the sensor.</li> <li>The temperature measurement function reads the voltage through analog input AI1 or AI2 and converts it to degrees Celsius.</li> </ul> <p>2 = 2 x PT100 – Sensor configuration uses two PT100 sensors.</p> <ul style="list-style-type: none"> <li>Operation is the same as for above 1 x PT100.</li> </ul> <p>3 = 3 x PT100 – Sensor configuration uses three PT100 sensors.</p> <ul style="list-style-type: none"> <li>Operation is the same as for above 1 x PT100.</li> </ul> <p>4 = PTC – Sensor configuration uses one PTC.</p> <ul style="list-style-type: none"> <li>The analog output feeds a constant current through the sensor.</li> <li>The resistance of the sensor increases sharply as the motor temperature rises over the PTC reference temperature (<math>T_{ref}</math>), as does the voltage over the resistor. The temperature measurement function reads the voltage through analog input AI1 and converts it into ohms.</li> <li>The table below and the graph show typical PTC sensor resistance as a function of the motor operating temperature.</li> </ul> <table border="1" data-bbox="228 951 652 1045"> <thead> <tr> <th>Temperature</th> <th>Resistance</th> </tr> </thead> <tbody> <tr> <td>Normal</td> <td>&lt; 1.5 kohm</td> </tr> <tr> <td>Excessive</td> <td>&gt; 4 kohm</td> </tr> </tbody> </table> <p>5 = THERM(0) – Sensor configuration uses a thermistor.</p> <ul style="list-style-type: none"> <li>Motor thermal protection is activated through a digital input. Connect either a PTC sensor or a normally closed thermistor relay to a digital input.</li> <li>When the digital input is '0', the motor is overheated.</li> <li>See the connection figure on page <a href="#">159</a>.</li> <li>The table below and the graph show the resistance requirements for a PTC sensor connected between 24 V and a digital input as a function of the motor operating temperature.</li> </ul> <table border="1" data-bbox="228 1272 652 1367"> <thead> <tr> <th>Temperature</th> <th>Resistance</th> </tr> </thead> <tbody> <tr> <td>Normal</td> <td>&lt; 3 kohm</td> </tr> <tr> <td>Excessive</td> <td>&gt; 28 kohm</td> </tr> </tbody> </table> <p>6 = THERM(1) – Sensor configuration uses a thermistor.</p> <ul style="list-style-type: none"> <li>Motor thermal protection is activated through a digital input. Connect a normally open thermistor relay to a digital input.</li> <li>When the digital input is '1', the motor is overheated.</li> <li>See the connection figure on page <a href="#">159</a>.</li> </ul>	Temperature	Resistance	Normal	< 1.5 kohm	Excessive	> 4 kohm	Temperature	Resistance	Normal	< 3 kohm	Excessive	> 28 kohm
Temperature	Resistance												
Normal	< 1.5 kohm												
Excessive	> 4 kohm												
Temperature	Resistance												
Normal	< 3 kohm												
Excessive	> 28 kohm												
3502	<p><b>INPUT SELECTION</b></p> <p>Defines the input used for the temperature sensor.</p> <p>1 = AI1 – PT100 and PTC. 2 = AI2 – PT100 and PTC. 3...8 = DI1...DI6 – Thermistor and PTC</p>												
3503	<p><b>ALARM LIMIT</b></p> <p>Defines the alarm limit for motor temperature measurement.</p> <ul style="list-style-type: none"> <li>At motor temperatures above this limit, the drive displays an alarm (2010, MOTOR TEMP)</li> </ul> <p>For thermistors or PTC connected to a digital input:</p> <p>0 – de-activated 1 – activated</p>												

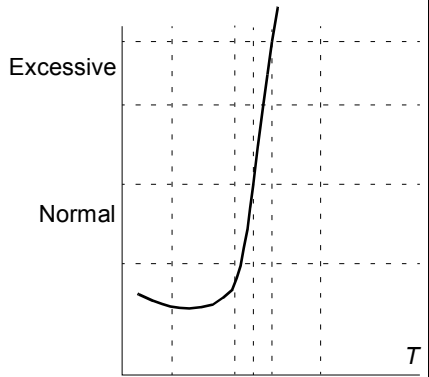



Code	Description
3504	<b>FAULT LIMIT</b> Defines the fault limit for motor temperature measurement. <ul style="list-style-type: none"><li>• At motor temperatures above this limit, the drive displays a fault (9, MOT OVERTEMP) and stops the drive.</li></ul> For thermistors or PTC connected to a digital input: 0 – de-activated 1 – activated

**Group 36: TIMED FUNCTIONS**

This group defines the timed functions. The timed functions include:

- four daily start and stop times
- four weekly start, stop and boost times
- four timers for collecting selected periods together.

A timer can be connected to multiple time periods and a time period can be in multiple timers.

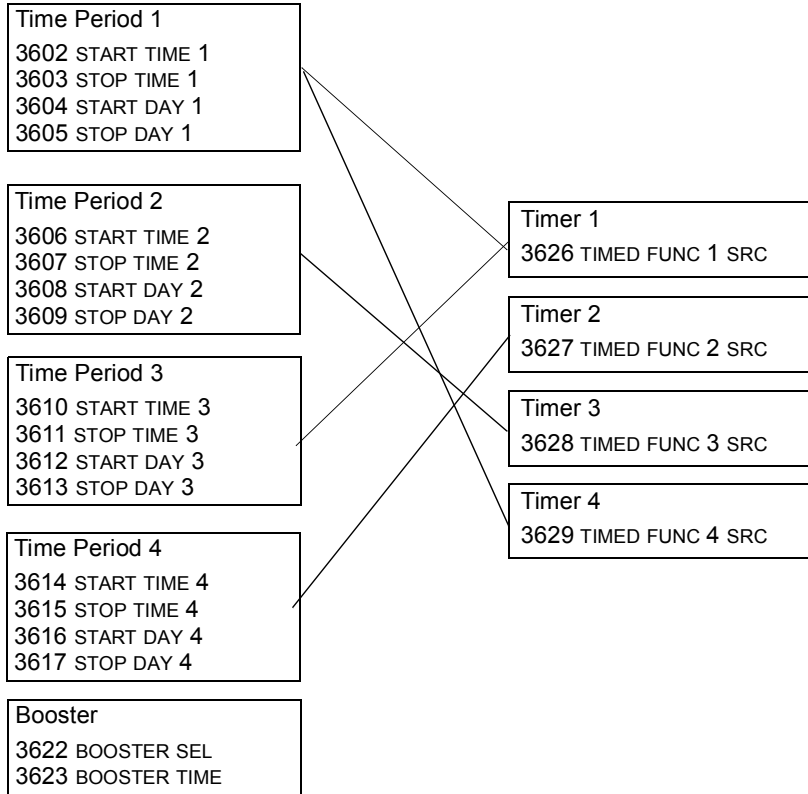

A parameter can be connected to only one timer.

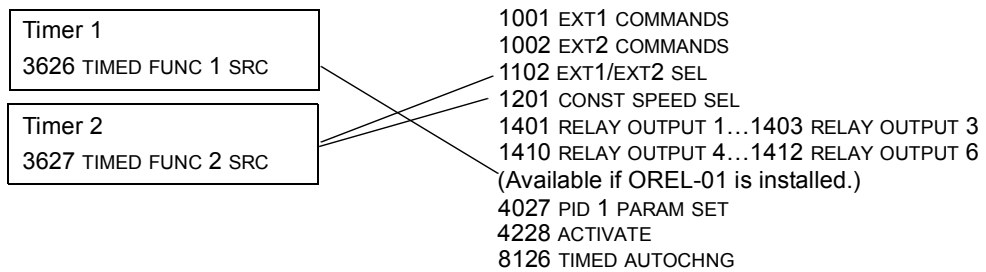

You can use the Timed functions assistant for easy configuring. For more information on the assistants, see section [Assistants mode](#) on page 57.

Code	Description
3601	<p><b>TIMERS ENABLE</b></p> <p>Selects the source for the timer enable signal.</p> <p>0 = NOT SEL – Timed functions are disabled.</p> <p>1 = DI1 – Defines digital input DI1 as the timed function enable signal.</p> <ul style="list-style-type: none"> <li>The digital input must be activated to enable the timed function.</li> </ul> <p>2...6 = DI2...DI6 – Defines digital input DI2...DI6 as the timed function enable signal.</p> <p>7 = ACTIVE – Timed functions are enabled.</p> <p>-1 = DI1(INV) – Defines an inverted digital input DI1 as the timed function enable signal.</p> <ul style="list-style-type: none"> <li>This digital input must be de-activated to enable the timed function.</li> </ul> <p>-2...-6 = DI2(INV)...DI6(INV) – Defines an inverted digital input DI2...DI6 as the timed function enable signal.</p>
3602	<p><b>START TIME 1</b></p> <p>Defines the daily start time. 20:30:00</p> <ul style="list-style-type: none"> <li>The time can be changed in steps of 2 seconds.</li> <li>If parameter value is 07:00:00, the timer is activated at 7 a.m.</li> <li>The figure shows multiple timers on different weekdays.</li> </ul> <p>17:00:00</p> <p>15:00:00</p> <p>13:00:00</p> <p>12:00:00</p> <p>10:30:00</p> <p>09:00:00</p> <p>00:00:00</p> <p>Time period 2</p> <p>Time period 4</p> <p>Time period 3</p> <p>Time period 1</p> <p>Mon Tue Wed Thu Fri Sat Sun</p>
3603	<p><b>STOP TIME 1</b></p> <p>Defines the daily stop time.</p> <ul style="list-style-type: none"> <li>The time can be changed in steps of 2 seconds.</li> <li>If the parameter value is 09:00:00, the timer is deactivated at 9 a.m.</li> </ul>
3604	<p><b>START DAY 1</b></p> <p>Defines the weekly start day.</p> <p>1 = MONDAY...7 = SUNDAY</p> <ul style="list-style-type: none"> <li>If parameter value is 1, timer 1 weekly is active from Monday midnight (00:00:00).</li> </ul>
3605	<p><b>STOP DAY 1</b></p> <p>Defines weekly stop day.</p> <p>1 = MONDAY...7 = SUNDAY</p> <ul style="list-style-type: none"> <li>If parameter value is 5, timer 1 weekly is deactivated on Friday midnight (23:59:58).</li> </ul>
3606	<p><b>START TIME 2</b></p> <p>Defines timer2 daily start time.</p> <ul style="list-style-type: none"> <li>See parameter 3602.</li> </ul>
3607	<p><b>STOP TIME 2</b></p> <p>Defines timer 2 daily stop time.</p> <ul style="list-style-type: none"> <li>See parameter 3603.</li> </ul>
3608	<p><b>START DAY 2</b></p> <p>Defines timer 2 weekly start day.</p> <ul style="list-style-type: none"> <li>See parameter 3604.</li> </ul>
3609	<p><b>STOP DAY 2</b></p> <p>Defines timer 2 weekly stop day.</p> <ul style="list-style-type: none"> <li>See parameter 3605.</li> </ul>
3610	<p><b>START TIME 3</b></p> <p>Defines timer 3 daily start time.</p> <ul style="list-style-type: none"> <li>See parameter 3602.</li> </ul>
3611	<p><b>STOP TIME 3</b></p> <p>Defines timer 3 daily stop time.</p> <ul style="list-style-type: none"> <li>See parameter 3603.</li> </ul>

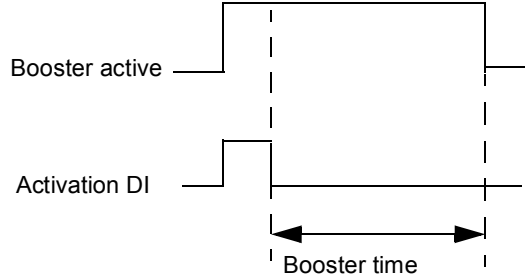
Code	Description
3612	<b>START DAY 3</b> Defines timer 3 weekly start day. • See parameter 3604.
3613	<b>STOP DAY 3</b> Defines timer 3 weekly stop day. • See parameter 3605.
3614	<b>START TIME 4</b> Defines timer 4 daily start time. • See parameter 3602.
3615	<b>STOP TIME 4</b> Defines timer 4 daily stop time. • See parameter 3603.
3616	<b>START DAY 4</b> Defines timer 4 weekly start day. • See parameter 3604.
3617	<b>STOP DAY 4</b> Defines timer 4 weekly stop day. • See parameter 3605.
3622	<b>BOOSTER SEL</b> Selects the source for the booster signal. 0 = NOT SEL – Booster signal is disabled. 1 = DI1 – Defines DI1 as the booster signal. 2...6 = DI2...DI6 – Defines DI2...DI6 as the booster signal. -1 = DI1(INV) – Defines an inverted digital input DI1 as the booster signal. -2...-6 = DI2(INV)...DI6(INV) – Defines an inverted digital input DI2...DI6 as the booster signal.
3623	<b>BOOSTER TIME</b> Defines the booster ON time. Time is started when booster sel signal is released. If parameter value is 01:30:00, booster is active for 1 hour and 30 minutes after activation DI is released. 
3626	<b>TIMED FUNC 1 SRC</b> Defines the time periods used by the timer. 0 = NOT SEL – No time periods have been selected. 1 = T1 – Time Period 1 selected in the timer. 2 = T2 – Time Period 2 selected in the timer. 3 = T1+T2 – Time Periods 1 and 2 selected in the timer. 4 = T3 – Time Period 3 selected in the timer. 5 = T1+T3 – Time Periods 1 and 3 selected in the timer. 6 = T2+T3 – Time Periods 2 and 3 selected in the timer. 7 = T1+T2+T3 – Time Periods 1, 2 and 3 selected in the timer. 8 = T4 – Time Period 4 selected in the timer. 9 = T1+T4 – Time Periods 1 and 4 selected in the timer. 10 = T2+T4 – Time Periods 2 and 4 selected in the timer. 11 = T1+T2+T4 – Time Periods 1, 2 and 4 selected in the timer. 12 = T3+T4 – Time Periods 3 and 4 selected in the timer. 13 = T1+T3+T4 – Time Periods 1, 3 and 4 selected in the timer. 14 = T2+T3+T4 – Time Periods 2, 3 and 4 selected in the timer. 15 = T1+T2+T3+T4 – Time Periods 1, 2, 3 and 4 selected in the timer. 16 = BOOSTER – Booster selected in the timer. 17 = T1+B – Booster and Time Period 1 selected in the timer. 18 = T2+B – Booster and Time Period 2 selected in the timer. 19 = T1+T2+B – Booster and Time Periods 1 and 2 selected in the timer. 20 = T3+B – Booster and Time Period 3 selected in the timer.

Code	Description
	21 = T1+T3+B – Booster and Time Periods 1 and 3 selected in the timer. 22 = T2+T3+B – Booster and Time Periods 2 and 3 selected in the timer. 23 = T1+T2+T3+B – Booster and Time Periods 1, 2 and 3 selected in the timer. 24 = T4+B – Booster and Time Period 4 selected in the timer. 25 = T1+T4+B – Booster and Time Periods 1 and 4 selected in the timer. 26 = T2+T4+B – Booster and Time Periods 2 and 4 selected in the timer. 27 = T1+T2+T4+B – Booster and Time Periods 1, 2 and 4 selected in the timer. 28 = T3+T4+B – Booster and Time Periods 3 and 4 selected in the timer. 29 = T1+T3+T4+B – Booster and Time Periods 1, 3 and 4 selected in the timer. 30 = T2+T3+T4+B – Booster and Time Periods 2, 3 and 4 selected in the timer. 31 = T1+2+3+4+B – Booster and Time Periods 1, 2, 3 and 4 selected in the timer.
3627	<b>TIMED FUNC 2 SRC</b> • See parameter 3626.
3628	<b>TIMED FUNC 3 SRC</b> • See parameter 3626.
3629	<b>TIMED FUNC 4 SRC</b> • See parameter 3626.

### Group 37: USER LOAD CURVE

This group defines supervision of user adjustable load curves (motor torque as a function of frequency). The curve is defined by five points.

Code	Description
3701	<p><b>USER LOAD C MODE</b> Supervision mode for the user adjustable load curves.</p> <p>This functionality replaces the former underload supervision in <i>Group 30: FAULT FUNCTIONS</i>. To emulate it, see section <i>Correspondence with the obsolete underload supervision</i> on page 167.</p> <p>0 = NOT SEL – Supervision is not active.                      1 = UNDERLOAD – Supervision for the torque dropping below the underload curve.                      2 = OVERLOAD – Supervision for the torque exceeding the overload curve.                      3 = BOTH – Supervision for the torque dropping below the underload curve or exceeding the overload curve.</p>
3702	<p><b>USER LOAD C FUNC</b> Action wanted during load supervision.</p> <p>1 = FAULT – A fault is generated when the condition defined by 3701 USER LOAD C MODE has been valid longer than the time set by 3703 USER LOAD C TIME.                      2 = ALARM – An alarm is generated when the condition defined by 3701 USER LOAD C MODE has been valid longer than half of the time defined by 3703 USER LOAD C TIME.</p>
3703	<p><b>USER LOAD C TIME</b> Defines the time limit for generating a fault.</p> <ul style="list-style-type: none"> <li>• Half of this time is used as the limit for generating an alarm.</li> </ul>
3704	<p><b>LOAD FREQ 1</b> Defines the frequency value of the first load curve definition point.</p> <ul style="list-style-type: none"> <li>• Must be smaller than 3707 LOAD FREQ 2.</li> </ul>
3705	<p><b>LOAD TORQ LOW 1</b> Defines the torque value of the first underload curve definition point.</p> <ul style="list-style-type: none"> <li>• Must be smaller than 3706 LOAD TORQ HIGH 1.</li> </ul>
3706	<p><b>LOAD TORQ HIGH 1</b> Defines the torque value of the first overload curve definition point.</p>
3707	<p><b>LOAD FREQ 2</b> Defines the frequency value of the second load curve definition point.</p> <ul style="list-style-type: none"> <li>• Must be smaller than 3710 LOAD FREQ 3.</li> </ul>
3708	<p><b>LOAD TORQ LOW 2</b> Defines the torque value of the second underload curve definition point.</p> <ul style="list-style-type: none"> <li>• Must be smaller than 3709 LOAD TORQ HIGH 2.</li> </ul>
3709	<p><b>LOAD TORQ HIGH 2</b> Defines the torque value of the second overload curve definition point.</p>
3710	<p><b>LOAD FREQ 3</b> Defines the frequency value of the third load curve definition point.</p> <ul style="list-style-type: none"> <li>• Must be smaller than 3713 LOAD FREQ 4.</li> </ul>
3711	<p><b>LOAD TORQ LOW 3</b> Defines the torque value of the third underload curve definition point.</p> <ul style="list-style-type: none"> <li>• Must be smaller than 3712 LOAD TORQ HIGH 3.</li> </ul>
3712	<p><b>LOAD TORQ HIGH 3</b> Defines the torque value of the third overload curve definition point.</p>

Code	Description
3713	<b>LOAD FREQ 4</b> Defines the frequency value of the fourth load curve definition point. • Must be smaller than 3716 LOAD FREQ 5
3714	<b>LOAD TORQ LOW 4</b> Defines the torque value of the fourth underload curve definition point. • Must be smaller than 3715 LOAD TORQ HIGH 4.
3715	<b>LOAD TORQ HIGH 4</b> Defines the torque value of the fourth overload curve definition point.
3716	<b>LOAD FREQ 5</b> Defines the frequency value of fifth load curve definition point.
3717	<b>LOAD TORQ LOW 5</b> Defines the torque value of the fifth underload curve definition point. • Must be smaller than 3718 LOAD TORQ HIGH 5.
3718	<b>LOAD TORQ HIGH 5</b> Defines the torque value of the fifth overload curve definition point.

*Correspondence with the obsolete underload supervision*

The now obsolete parameter 3015 UNDERLOAD CURVE provided five selectable curves shown in the figure. The parameter characteristics were as described below.

- If the load drops below the set curve for longer than the time set by parameter 3014 UNDERLOAD TIME (obsolete), the underload protection is activated.
- Curves 1...3 reach maximum at the motor rated frequency set by parameter 9907 MOTOR NOM FREQ.
- $T_M$  = nominal torque of the motor.
- $f_N$  = nominal frequency of the motor.

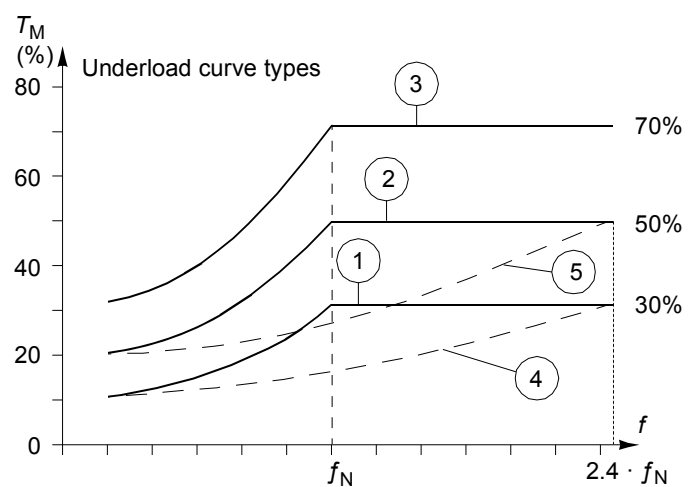

If you want to emulate the behavior of an old underload curve with parameters as in the shaded columns, set the new parameters as in the white columns in the two tables below:

Underload supervision with parameters 3013...3015 (obsolete)	Obsolete parameters		New parameters		
	3013 UNDERLOAD FUNCTION	3014 UNDERLOAD TIME	3701 USER LOAD C MODE	3702 USER LOAD C FUNC	3703 USER LOAD C TIME
No underload functionality	0	-	0	-	-
Underload curve, fault generated	1	t	1	1	t
Underload curve, alarm generated	2	t	1	2	2 · t

Obs. par.	New parameters															
	3015 UNDER LOAD LOAD CURVE	3704 LOAD FREQ 1  (Hz)		3705 LOAD TORQ LOW 1  (%)	3707 LOAD FREQ 2  (Hz)		3708 LOAD TORQ LOW 2  (%)	3710 LOAD FREQ 3  (Hz)		3711 LOAD TORQ LOW 3  (%)	3713 LOAD FREQ 4  (Hz)		3714 LOAD TORQ LOW 4  (%)	3716 LOAD FREQ 5  (Hz)		3717 LOAD TORQ LOW 5  (%)
		EU	US		EU	US		EU	US		EU	US		EU	US	
1	5	6	10	32	38	17	41	50	23	50	60	30	500	500	30	
2	5	6	20	31	37	30	42	50	40	50	60	50	500	500	50	
3	5	6	30	31	37	43	42	50	57	50	60	70	500	500	70	
4	5	6	10	73	88	17	98	117	23	120	144	30	500	500	30	
5	5	6	20	71	86	30	99	119	40	120	144	50	500	500	50	



**Group 40: PROCESS PID SET 1**

This group defines a set of parameters used with the Process PID (PID1) controller. Typically only parameters in this group are needed.

*PID controller – Basic set-up*

In PID control mode, the drive compares a reference signal (setpoint) to an actual signal (feedback) and automatically adjusts the speed of the drive to match the two signals. The difference between the two signals is the error value.

Typically PID control mode is used, when the speed of a motor needs to be controlled based on pressure, flow or temperature. In most cases – when there is only 1 transducer signal wired to the ACS550 – only parameter group 40 is needed.

The following is a schematic of setpoint/feedback signal flow using parameter group 40.

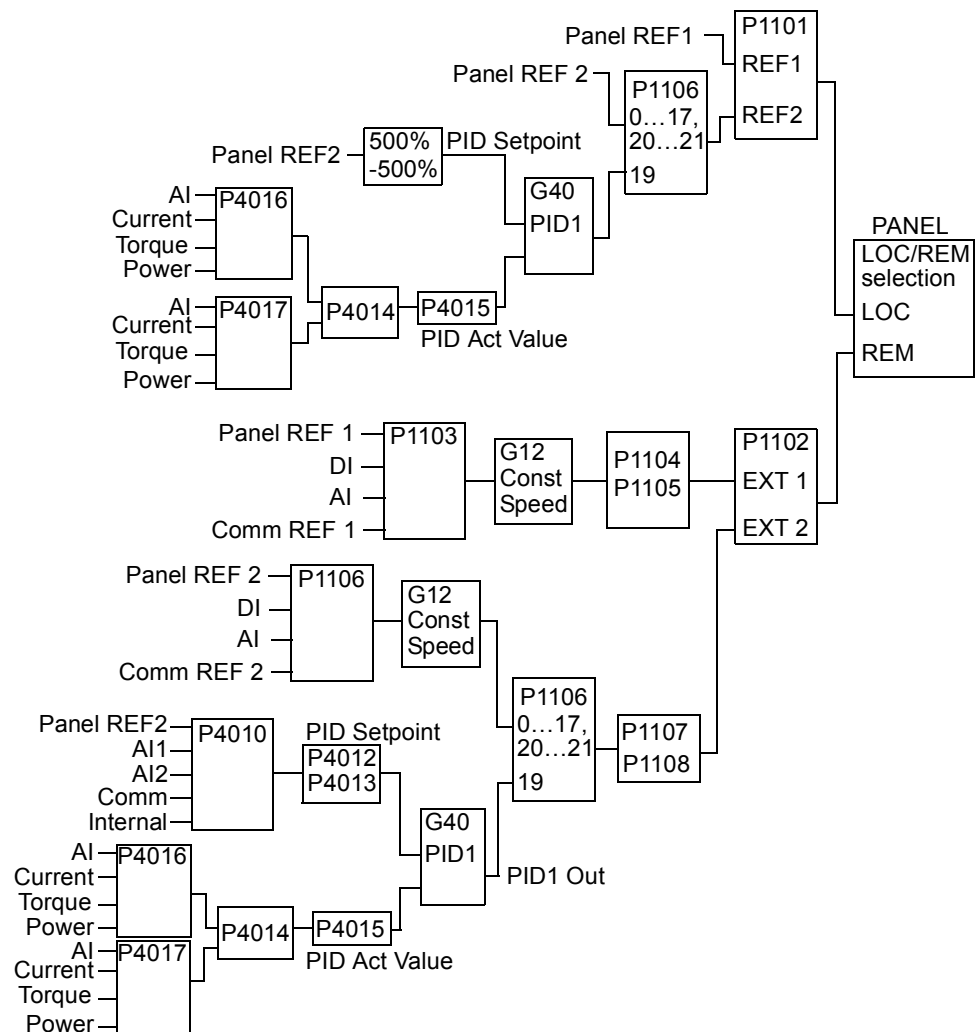

**Note:** In order to activate and use the PID controller, parameter 1106 must be set to value 19.

### PID controller – Advanced

The ACS550 has two separate PID controllers:

- Process PID (PID1) and
- External PID (PID2)

Process PID (PID1) has 2 separate sets of parameters:

- Process PID (PID1) SET1, defined in [Group 40: PROCESS PID SET 1](#) and
- Process PID (PID1) SET2, defined in [Group 41: PROCESS PID SET 2](#)

You can select between the two different sets by using parameter 4027.

Typically two different PID controller sets are used when the load of the motor changes considerably from one situation to another.

You can use External PID (PID2), defined in [Group 42: EXT / TRIM PID](#), in two different ways:

- Instead of using additional PID controller hardware, you can set outputs of the ACS550 to control a field instrument like a damper or a valve. In this case, set parameter 4230 to value 0. (0 is the default value.)
- You can use External PID (PID2) to trim or fine-tune the speed of the ACS550.

Code	Description
4001	<p><b>GAIN</b></p> <p>Defines the PID controller's gain.</p> <ul style="list-style-type: none"> <li>• The setting range is 0.1... 100.</li> <li>• At 0.1, the PID controller output changes one-tenth as much as the error value.</li> <li>• At 100, the PID controller output changes one hundred times as much as the error value.</li> </ul> <p>Use the proportional gain and integration time values to adjust the responsiveness of the system.</p> <ul style="list-style-type: none"> <li>• A low value for proportional gain and a high value for integral time ensures stable operation, but provides sluggish response.</li> </ul> <p>If the proportional gain value is too large or the integral time too short, the system can become unstable.</p> <p>Procedure:</p> <ul style="list-style-type: none"> <li>• Initially, set: <ul style="list-style-type: none"> <li>• 4001 GAIN = 0.1.</li> <li>• 4002 INTEGRATION TIME = 20 seconds.</li> </ul> </li> <li>• Start the system and see if it reaches the setpoint quickly while maintaining stable operation. If not, increase GAIN (4001) until the actual signal (or drive speed) oscillates constantly. It may be necessary to start and stop the drive to induce this oscillation.</li> <li>• Reduce GAIN (4001) until the oscillation stops.</li> <li>• Set GAIN (4001) to 0.4 to 0.6 times the above value.</li> <li>• Decrease the INTEGRATION TIME (4002) until the feedback signal (or drive speed) oscillates constantly. It may be necessary to start and stop the drive to induce this oscillation.</li> <li>• Increase INTEGRATION TIME (4002) until the oscillation stops.</li> <li>• Set INTEGRATION TIME (4002) to 1.15 to 1.5 times the above value.</li> <li>• If the feedback signal contains high frequency noise, increase the value of parameter 1303 FILTER AI1 or 1306 FILTER AI2 until the noise is filtered from the signal.</li> </ul>

Code	Description																		
4002	<p><b>INTEGRATION TIME</b></p> <p>Defines the PID controller's integration time.</p> <p>Integration time is, by definition, the time required to increase the output by the error value:</p> <ul style="list-style-type: none"> <li>• Error value is constant and 100%.</li> <li>• Gain = 1.</li> <li>• Integration time of 1 second denotes that a 100% change is achieved in 1 second.</li> </ul> <p>0.0 = NOT SEL – Disables integration (I-part of controller).                      0.1...3600.0 – Integration time (seconds).</p> <ul style="list-style-type: none"> <li>• See 4001 for adjustment procedure.</li> </ul>																		
	<p>A = Error                      B = Error value step                      C = Controller output with Gain = 1                      D = Controller output with Gain = 10</p>																		
4003	<p><b>DERIVATION TIME</b></p> <p>Defines the PID controller's derivation time.</p> <ul style="list-style-type: none"> <li>• You can add the derivative of the error to the PID controller output. The derivative is the error value's rate of change. For example, if the process error value changes linearly, the derivative is a constant added to the PID controller output.</li> <li>• The error-derivative is filtered with a 1-pole filter. The time constant of the filter is defined by parameter 4004 PID DERIV FILTER.</li> </ul> <p>0.0...10.0 – Derivation time (seconds).</p>																		
	<p>Process error value</p> <p>PID output</p> <p>D-part of controller output</p> <p>Gain P 4001</p> <p>P 4003</p>																		
4004	<p><b>PID DERIV FILTER</b></p> <p>Defines the filter time constant for the error-derivative part of the PID controller output.</p> <ul style="list-style-type: none"> <li>• Before being added to the PID controller output, the error-derivative is filtered with a 1-pole filter.</li> <li>• Increasing the filter time smooths the error-derivative, reducing noise.</li> </ul> <p>0.0...10.0 – Filter time constant (seconds).</p>																		
4005	<p><b>ERROR VALUE INV</b></p> <p>Selects either a normal or inverted relationship between the feedback signal and the drive speed.</p> <p>0 = NO – Normal, a decrease in feedback signal increases drive speed. Error = Ref - Fbk                      1 = YES – Inverted, a decrease in feedback signal decreases drive speed. Error = Fbk - Ref</p>																		
4006	<p><b>UNITS</b></p> <p>Selects the unit for the PID controller actual values. (PID1 parameters 0128, 0130 and 0132).</p> <ul style="list-style-type: none"> <li>• See parameter 3405 for list of available units.</li> </ul>																		
4007	<p><b>UNIT SCALE</b></p> <p>Defines the decimal point location in PID controller actual values.</p> <ul style="list-style-type: none"> <li>• Enter the decimal point location counting in from the right end of the entry.</li> <li>• See the table for an example using pi (3.14159).</li> </ul> <table border="1" style="margin-left: auto; margin-right: auto;"> <thead> <tr> <th>4007 value</th> <th>Entry</th> <th>Display</th> </tr> </thead> <tbody> <tr> <td>0</td> <td>00003</td> <td>3</td> </tr> <tr> <td>1</td> <td>00031</td> <td>3.1</td> </tr> <tr> <td>2</td> <td>00314</td> <td>3.14</td> </tr> <tr> <td>3</td> <td>03142</td> <td>3.142</td> </tr> <tr> <td>4</td> <td>31416</td> <td>3.1416</td> </tr> </tbody> </table>	4007 value	Entry	Display	0	00003	3	1	00031	3.1	2	00314	3.14	3	03142	3.142	4	31416	3.1416
4007 value	Entry	Display																	
0	00003	3																	
1	00031	3.1																	
2	00314	3.14																	
3	03142	3.142																	
4	31416	3.1416																	

Code	Description	
4008	<b>0% VALUE</b> Defines (together with the next parameter) the scaling applied to the PID controller's actual values (PID1 parameters 0128, 0130 and 0132). • Units and scale are defined by parameters 4006 and 4007.	
4009	<b>100% VALUE</b> Defines (together with the previous parameter) the scaling applied to the PID controller's actual values. • Units and scale are defined by parameters 4006 and 4007.	
4010	<b>SET POINT SEL</b> Defines the reference signal source for the PID controller. <ul style="list-style-type: none"> <li>• Parameter has no significance when the PID regulator is by-passed (see 8121 REG BYPASS CTRL).</li> <li>0 = KEYPAD – Control panel provides reference.</li> <li>1 = AI1 – Analog input 1 provides reference.</li> <li>2 = AI2 – Analog input 2 provides reference.</li> <li>8 = COMM – Fieldbus provides reference.</li> <li>9 = COMM+AI1 – Defines a fieldbus and analog input 1 (AI1) combination as the reference source. See Analog input reference correction below.</li> <li>10 = COMM*AI1 – Defines a fieldbus and analog input 1 (AI1) combination as the reference source. See Analog input reference correction below.</li> <li>11 = DI3U,4D(RNC) – Digital inputs, acting as a motor potentiometer control, provide reference.               <ul style="list-style-type: none"> <li>• DI3 increases the speed (the U stands for “up”)</li> <li>• DI4 decreases the reference (the D stands for “down”).</li> <li>• Parameter 2205 ACCELER TIME 2 controls the reference signal's rate of change.</li> <li>• R = Stop command resets the reference to zero.</li> <li>• NC = Reference value is not copied.</li> </ul> </li> <li>12 = DI3U,4D(NC) – Same as DI3U,4D(RNC) above, except:               <ul style="list-style-type: none"> <li>• Stop command does not reset reference to zero. At restart the motor ramps up, at the selected acceleration rate, to the stored reference.</li> </ul> </li> <li>13 = DI5U,6D(NC) – Same as DI3U,4D(NC) above, except:               <ul style="list-style-type: none"> <li>• Uses digital inputs DI5 and DI6.</li> </ul> </li> <li>14 = AI1+AI2 – Defines an analog input 1 (AI1) and analog input 2 (AI2) combination as the reference source. See Analog input reference correction below.</li> <li>15 = AI1*AI2 – Defines an analog input 1 (AI1) and analog input 2 (AI2) combination as the reference source. See Analog input reference correction below.</li> <li>16 = AI1-AI2 – Defines an analog input 1 (AI1) and analog input 2 (AI2) combination as the reference source. See Analog input reference correction below.</li> <li>17 = AI1/AI2 – Defines an analog input 1 (AI1) and analog input 2 (AI2) combination as the reference source. See Analog input reference correction below.</li> <li>19 = INTERNAL – A constant value set using parameter 4011 provides reference.</li> <li>20 = PID2OUT – Defines PID controller 2 output (parameter 0127 PID 2 OUTPUT) as the reference source.</li> </ul>	

Code	Description										
	<p><b>Analog input reference correction</b> Parameter values 9, 10 and 14...17 use the formula in the following table.</p> <table border="1"> <thead> <tr> <th>Value setting</th> <th>Calculation of the AI reference</th> </tr> </thead> <tbody> <tr> <td>C + B</td> <td>C value + (B value - 50% of reference value)</td> </tr> <tr> <td>C * B</td> <td>C value · (B value / 50% of reference value)</td> </tr> <tr> <td>C - B</td> <td>(C value + 50% of reference value) - B value</td> </tr> <tr> <td>C / B</td> <td>(C value · 50% of reference value) / B value</td> </tr> </tbody> </table> <p>Where:</p> <ul style="list-style-type: none"> <li>C = Main reference value ( = COMM for values 9, 10 and = AI1 for values 14...17)</li> <li>B = Correcting reference ( = AI1 for values 9, 10 and = AI2 for values 14...17).</li> </ul> <p><b>Example:</b> The figure shows the reference source curves for value settings 9, 10 and 14...17, where:</p> <ul style="list-style-type: none"> <li>C = 25%.</li> <li>P 4012 SETPOINT MIN = 0.</li> <li>P 4013 SETPOINT MAX = 0.</li> <li>B varies along the horizontal axis.</li> </ul>	Value setting	Calculation of the AI reference	C + B	C value + (B value - 50% of reference value)	C * B	C value · (B value / 50% of reference value)	C - B	(C value + 50% of reference value) - B value	C / B	(C value · 50% of reference value) / B value
Value setting	Calculation of the AI reference										
C + B	C value + (B value - 50% of reference value)										
C * B	C value · (B value / 50% of reference value)										
C - B	(C value + 50% of reference value) - B value										
C / B	(C value · 50% of reference value) / B value										
4011	<p><b>INTERNAL SETPNT</b> Sets a constant value used for the process reference. • Units and scale are defined by parameters 4006 and 4007.</p>										
4012	<p><b>SETPOINT MIN</b> Sets the minimum value for the reference signal source. • See parameter 4010.</p>										
4013	<p><b>SETPOINT MAX</b> Sets the maximum value for the reference signal source. • See parameter 4010.</p>										
4014	<p><b>FBK SEL</b> Defines the PID controller feedback (actual signal). • You can define a combination of two actual values (ACT1 and ACT2) as the feedback signal. • Use parameter 4016 to define the source for actual value 1 (ACT1). • Use parameter 4017 to define the source for actual value 2 (ACT2). 1 = ACT1 – Actual value 1 (ACT1) provides the feedback signal. 2 = ACT1-ACT2 – ACT1 minus ACT2 provides the feedback signal. 3 = ACT1+ACT2 – ACT1 plus ACT2 provides the feedback signal. 4 = ACT1*ACT2 – ACT1 times ACT2 provides the feedback signal. 5 = ACT1/ACT2 – ACT1 divided by ACT2 provides the feedback signal. 6 = MIN(ACT1,2) – The smaller of ACT1 or ACT2 provides the feedback signal. 7 = MAX(ACT1,2) – The greater of ACT1 or ACT2 provides the feedback signal. 8 = sqrt(ACT1-2) – Square root of the value for ACT1 minus ACT2 provides the feedback signal. 9 = sqA1+sqA2 – Square root of ACT1 plus the square root of ACT2 provides the feedback signal. 10 = sqrt(ACT1) – Square root of ACT1 provides the feedback signal. 11 = COMM FBK 1 – Signal 0158 PID COMM VALUE 1 provides the feedback signal. 12 = COMM FBK 2 – Signal 0159 PID COMM VALUE 2 provides the feedback signal. 13 = AVE(ACT1,2) – The average of ACT1 and ACT2 provides the feedback signal.</p>										
4015	<p><b>FBK MULTIPLIER</b> Defines an extra multiplier for the PID feedback value FBK defined by parameter 4014. • Used mainly in applications where the flow is calculated from the pressure difference. 0.000 = NOT SEL – The parameter has no effect (1.000 used as the multiplier). -32.768...32.767 – Multiplier applied to the signal defined by parameter 4014 FBK SEL.</p> <p><b>Example:</b> <math>FBK = Multiplier \times \sqrt{A1 - A2}</math></p>										

Code	Description																								
4016	<p><b>ACT1 INPUT</b></p> <p>Defines the source for actual value 1 (ACT1). See also parameter 4018 ACT1 MINIMUM.</p> <p>1 = AI1 – Uses analog input 1 for ACT1.                  2 = AI2 – Uses analog input 2 for ACT1.                  3 = CURRENT – Uses current for ACT1.                  4 = TORQUE – Uses torque for ACT1.                  5 = POWER – Uses power for ACT1.                  6 = COMM ACT 1 – Uses value of signal 0158 PID COMM VALUE 1 for ACT1.                  7 = COMM ACT 2 – Uses value of signal 0159 PID COMM VALUE 2 for ACT1.</p>																								
4017	<p><b>ACT2 INPUT</b></p> <p>Defines the source for actual value 2 (ACT2). See also parameter 4020 ACT2 MINIMUM.</p> <p>1 = AI1 – Uses analog input 1 for ACT2.                  2 = AI2 – Uses analog input 2 for ACT2.                  3 = CURRENT – Uses current for ACT2.                  4 = TORQUE – Uses torque for ACT2.                  5 = POWER – Uses power for ACT2.                  6 = COMM ACT 1 – Uses value of signal 0158 PID COMM VALUE 1 for ACT2.                  7 = COMM ACT 2 – Uses value of signal 0159 PID COMM VALUE 2 for ACT2.</p>																								
4018	<p><b>ACT1 MINIMUM</b></p> <p>Sets the minimum value for ACT1.</p> <ul style="list-style-type: none"> <li>• Scales the source signal used as the actual value ACT1 (defined by parameter 4016 ACT1 INPUT). For parameter 4016 values 6 (COMM ACT 1) and 7 (COMM ACT 2) scaling is not done.</li> </ul> <table border="1"> <thead> <tr> <th>Par 4016</th> <th>Source</th> <th>Source min.</th> <th>Source max.</th> </tr> </thead> <tbody> <tr> <td>1</td> <td>Analog input 1</td> <td>1301 MINIMUM AI1</td> <td>1302 MAXIMUM AI1</td> </tr> <tr> <td>2</td> <td>Analog input 2</td> <td>1304 MINIMUM AI2</td> <td>1305 MAXIMUM AI2</td> </tr> <tr> <td>3</td> <td>Current</td> <td>0</td> <td>2 · nominal current</td> </tr> <tr> <td>4</td> <td>Torque</td> <td>-2 · nominal torque</td> <td>2 · nominal torque</td> </tr> <tr> <td>5</td> <td>Power</td> <td>-2 · nominal power</td> <td>2 · nominal power</td> </tr> </tbody> </table> <ul style="list-style-type: none"> <li>• See the figure: A= Normal; B = Inversion (ACT1 MINIMUM &gt; ACT1 MAXIMUM)</li> </ul>	Par 4016	Source	Source min.	Source max.	1	Analog input 1	1301 MINIMUM AI1	1302 MAXIMUM AI1	2	Analog input 2	1304 MINIMUM AI2	1305 MAXIMUM AI2	3	Current	0	2 · nominal current	4	Torque	-2 · nominal torque	2 · nominal torque	5	Power	-2 · nominal power	2 · nominal power
Par 4016	Source	Source min.	Source max.																						
1	Analog input 1	1301 MINIMUM AI1	1302 MAXIMUM AI1																						
2	Analog input 2	1304 MINIMUM AI2	1305 MAXIMUM AI2																						
3	Current	0	2 · nominal current																						
4	Torque	-2 · nominal torque	2 · nominal torque																						
5	Power	-2 · nominal power	2 · nominal power																						
4019	<p><b>ACT1 MAXIMUM</b></p> <p>Sets the maximum value for ACT1.</p> <ul style="list-style-type: none"> <li>• See 4018 ACT1 MINIMUM.</li> </ul>																								
4020	<p><b>ACT2 MINIMUM</b></p> <p>Sets the minimum value for ACT2.</p> <ul style="list-style-type: none"> <li>• See 4018 ACT1 MINIMUM.</li> </ul>																								
4021	<p><b>ACT2 MAXIMUM</b></p> <p>Sets the maximum value for ACT2.</p> <ul style="list-style-type: none"> <li>• See 4018 ACT1 MINIMUM.</li> </ul>																								
4022	<p><b>SLEEP SELECTION</b></p> <p>Defines the control for the PID sleep function.</p> <p>0 = NOT SEL– Disables the PID sleep control function.</p> <p>1 = DI1 – Defines digital input DI1 as the control for the PID sleep function.</p> <ul style="list-style-type: none"> <li>• Activating the digital input activates the sleep function.</li> <li>• De-activating the digital input restores PID control.</li> </ul> <p>2...6 = DI2...DI6 – Defines digital input DI2...DI6 as the control for the PID sleep function.</p> <ul style="list-style-type: none"> <li>• See DI1 above.</li> </ul> <p>7 = INTERNAL – Defines the output rpm/frequency, process reference and process actual value as the control for the PID sleep function. Refer to parameters 4025 WAKE-UP DEV and 4023 PID SLEEP LEVEL.</p> <p>-1 = DI1(INV) – Defines an inverted digital input DI1 as the control for the PID sleep function.</p> <ul style="list-style-type: none"> <li>• De-activating the digital input activates the sleep function.</li> <li>• Activating the digital input restores PID control.</li> </ul> <p>-2...-6 = DI2(INV)...DI6(INV) – Defines an inverted digital input DI2...DI6 as the control for the PID sleep function.</p> <ul style="list-style-type: none"> <li>• See DI1(INV) above.</li> </ul>																								

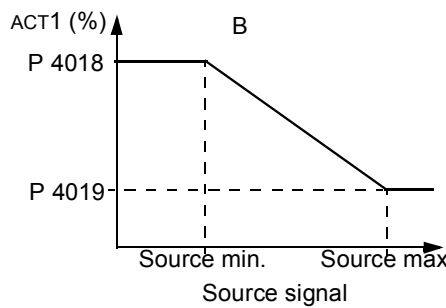
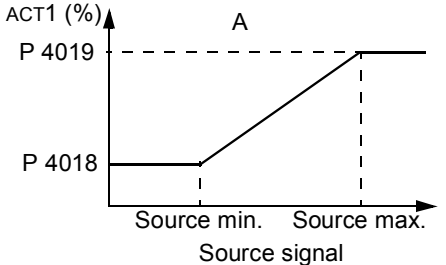

Code	Description	
4023	<p><b>PID SLEEP LEVEL</b></p> <p>Sets the motor speed / frequency that enables the PID sleep function – a motor speed / frequency below this level, for at least the time period 4024 PID SLEEP DELAY enables the PID sleep function (stopping the drive).</p> <ul style="list-style-type: none"> <li>Requires 4022 = 7 (INTERNAL).</li> <li>See the figure: A = PID output level; B = PID process feedback.</li> </ul>	
4024	<p><b>PID SLEEP DELAY</b></p> <p>Sets the time delay for the PID sleep function – a motor speed / frequency below 4023 PID SLEEP LEVEL for at least this time period enables the PID sleep function (stopping the drive).</p> <ul style="list-style-type: none"> <li>See 4023 PID SLEEP LEVEL above.</li> </ul>	
4025	<p><b>WAKE-UP DEV</b></p> <p>Defines the wake-up deviation – a deviation from the setpoint greater than this value, for at least the time period 4026 WAKE-UP DELAY, re-starts the PID controller.</p> <ul style="list-style-type: none"> <li>Parameters 4006 and 4007 define the units and scale.</li> <li>Parameter 4005 = 0, Wake-up level = Setpoint - Wake-up deviation.</li> <li>Parameter 4005 = 1, Wake-up level = Setpoint + Wake-up deviation.</li> <li>Wake-up level can be above or below setpoint.</li> </ul> <p>See the figures:</p> <ul style="list-style-type: none"> <li>C = Wake-up level when parameter 4005 = 1</li> <li>D = Wake-up level when parameter 4005 = 0</li> <li>E = Feedback is above wake-up level and lasts longer than 4026 WAKE-UP DELAY – PID function wakes up.</li> <li>F = Feedback is below wake-up level and lasts longer than 4026 WAKE-UP DELAY – PID function wakes up.</li> </ul>	
4026	<p><b>WAKE-UP DELAY</b></p> <p>Defines the wake-up delay – a deviation from the setpoint greater than 4025 WAKE-UP DEV, for at least this time period, re-starts the PID controller.</p>	

Code	Description
4027	<p><b>PID 1 PARAM SET</b></p> <p>Process PID (PID1) has two separate sets of parameters, PID set 1 and PID set 2.</p> <ul style="list-style-type: none"> <li>• PID set 1 uses parameters 4001...4026.</li> <li>• PID set 2 uses parameters 4101...4126.</li> </ul> <p>PID 1 PARAM SET defines which set is selected.</p> <p>0 = SET 1 – PID Set 1 (parameters 4001...4026) is active.</p> <p>1 = DI1 – Defines digital input DI1 as the control for PID Set selection.</p> <ul style="list-style-type: none"> <li>• Activating the digital input selects PID Set 2.</li> <li>• De-activating the digital input selects PID Set 1.</li> </ul> <p>2...6 = DI2...DI6 – Defines digital input DI2...DI6 as the control for PID Set selection.</p> <ul style="list-style-type: none"> <li>• See DI1 above.</li> </ul> <p>7 = SET 2 – PID Set 2 (parameters 4101...4126) is active.</p> <p>8...11 = TIMED FUNC 1...4 – Defines the Timed function as the control for the PID Set selection (Timed function de-activated = PID Set 1; Timed function activated = PID Set 2)</p> <ul style="list-style-type: none"> <li>• See <a href="#">Group 36: TIMED FUNCTIONS</a>.</li> </ul> <p>12 = 2-ZONE MIN – The drive calculates the difference between setpoint 1 and feedback 1 as well as setpoint 2 and feedback 2. The drive will control the zone (and select the set) that has a larger difference.</p> <ul style="list-style-type: none"> <li>• A positive difference (a setpoint higher than the feedback) is always larger than a negative difference. This keeps feedback values at or above the setpoint.</li> <li>• Controller does not react to the situation of feedback above setpoint if another zone's feedback is closer to its setpoint.</li> </ul> <p>13 = 2-ZONE MAX – The drive calculates the difference between setpoint 1 and feedback 1 as well as setpoint 2 and feedback 2. The drive will control the zone (and select the set) that has a smaller difference.</p> <ul style="list-style-type: none"> <li>• A negative difference (a setpoint lower than the feedback) is always smaller than a positive difference. This keeps feedback values at or below the setpoint.</li> <li>• Controller does not react to the situation of feedback below setpoint if another zone's feedback is closer to its setpoint.</li> </ul> <p>14 = 2-ZONE AVE – The drive calculates the difference between setpoint 1 and feedback 1 as well as setpoint 2 and feedback 2. In addition, it calculates the average of the deviations and uses it to control zone 1. Therefore one feedback is kept above its setpoint and another is kept as much below its setpoint.</p> <p>-1 = DI1(INV) – Defines an inverted digital input DI1 as the control for PID Set selection.</p> <ul style="list-style-type: none"> <li>• Activating the digital input selects PID Set 1.</li> <li>• De-activating the digital input selects PID Set 2.</li> </ul> <p>-2...-6 = DI2(INV)...DI6(INV) – Defines an inverted digital input DI2...DI6 as the control for PID Set selection.</p> <ul style="list-style-type: none"> <li>• See DI1(INV) above.</li> </ul>



**Group 41: PROCESS PID SET 2**

Parameters of this group belong to PID parameter set 2. The operation of parameters 4101...4126 is analogous with set 1 parameters 4001...4026.

PID parameter set 2 can be selected by parameter 4027 PID 1 PARAM SET.

Code	Description
4101	See 4001 ...4026
...	
4126	

## Group 42: EXT / TRIM PID

This group defines the parameters used for the second PID controller (PID2), which is used for the External / Trimming PID.

The operation of parameters 4201...4221 is analogous with Process PID set 1 (PID1) parameters 4001...4021.

Code	Description
4201 ... 4221	See 4001 ...4021
4228	<p><b>ACTIVATE</b></p> <p>Defines the source for enabling the external PID function.</p> <ul style="list-style-type: none"> <li>• Requires 4230 TRIM MODE = 0 (NOT SEL).</li> </ul> <p>0 = NOT SEL – Disables external PID control.</p> <p>1 = DI1 – Defines digital input DI1 as the control for enabling external PID control.</p> <ul style="list-style-type: none"> <li>• Activating the digital input enables external PID control.</li> <li>• De-activating the digital input disables external PID control.</li> </ul> <p>2...6 = DI2...DI6 – Defines digital input DI2...DI6 as the control for enabling external PID control.</p> <ul style="list-style-type: none"> <li>• See DI1 above.</li> </ul> <p>7 = DRIVE RUN – Defines the start command as the control for enabling external PID control.</p> <ul style="list-style-type: none"> <li>• Activating the start command (drive is running) enables external PID control.</li> </ul> <p>8 = ON – Defines the power-on as the control for enabling external PID control.</p> <ul style="list-style-type: none"> <li>• Activating power to the drive enables external PID control.</li> </ul> <p>9...12 = TIMED FUNC 1...4 – Defines the Timed function as the control for enabling external PID control (Timed function active enables external PID control).</p> <ul style="list-style-type: none"> <li>• See <a href="#">Group 36: TIMED FUNCTIONS</a>.</li> </ul> <p>-1 = DI1(INV) – Defines an inverted digital input DI1 as the control for enabling external PID control.</p> <ul style="list-style-type: none"> <li>• Activating the digital input disables external PID control.</li> <li>• De-activating the digital input enables external PID control.</li> </ul> <p>-2...-6 = DI2(INV)...DI6(INV) – Defines an inverted digital input DI2...DI6 as the control for enabling external PID control.</p> <ul style="list-style-type: none"> <li>• See DI1(INV) above.</li> </ul>
4229	<p><b>OFFSET</b></p> <p>Defines the offset for the PID output.</p> <ul style="list-style-type: none"> <li>• When PID is activated, output starts from this value.</li> <li>• When PID is deactivated, output resets to this value.</li> <li>• Parameter is active when 4230 TRIM MODE = 0 (trim mode is not active).</li> </ul>
4230	<p><b>TRIM MODE</b></p> <p>Selects the type of trim, if any. Using the trim it is possible to combine a corrective factor to the drive reference.</p> <p>0 = NOT SEL – Disables the trim function.</p> <p>1 = PROPORTIONAL – Adds a trim factor that is proportional to the rpm/Hz reference.</p> <p>2 = DIRECT – Adds a trim factor based on the control loop's maximum limit.</p>
4231	<p><b>TRIM SCALE</b></p> <p>Defines the multiplier (as a percent, plus or minus) used in the trim mode.</p>

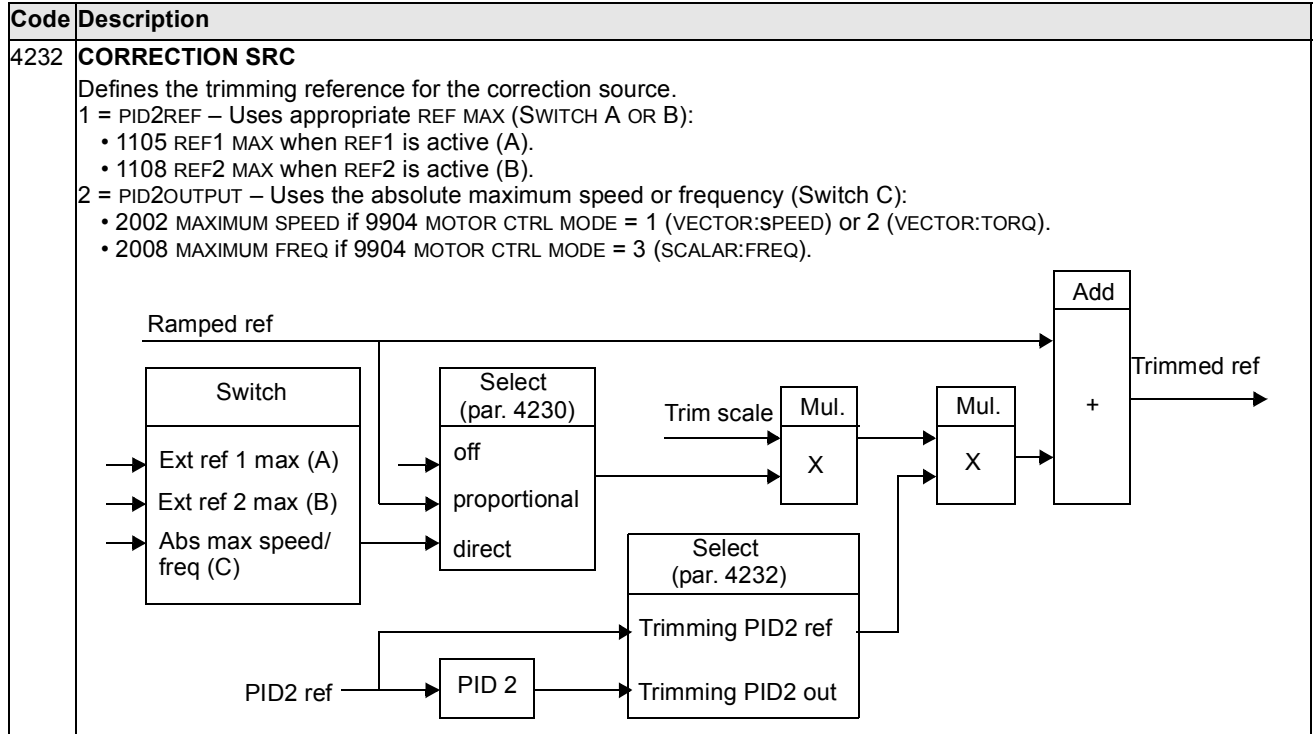

### Group 45: ENERGY SAVING

This group defines the setup of calculation and optimization of energy savings.

**Note:** The values of saved energy parameters 0174 SAVED KWH, 0175 SAVED MWH, 0176 SAVED AMOUNT 1, 0177 SAVED AMOUNT 2 and 0178 SAVED CO2 are derived from subtracting the drive's energy consumed from the direct-on-line (DOL) consumption calculated on the basis of parameter 4508 PUMP POWER. As such, the accuracy of the values is dependent on the accuracy of the power estimate entered in that parameter.

Code	Description
4502	<p><b>ENERGY PRICE</b></p> <p>Price of energy per kWh.</p> <ul style="list-style-type: none"> <li>Used for reference when energy savings are calculated.</li> <li>See parameters 0174 SAVED KWH, 0175 SAVED MWH, 0176 SAVED AMOUNT 1, 0177 SAVED AMOUNT 2 and 0178 SAVED CO2 (reduction on carbon dioxide emissions in tn).</li> </ul>
4507	<p><b>CO2 CONV FACTOR</b></p> <p>Conversion factor for converting energy into CO2 emissions (kg/kWh or tn/MWh). Used for multiplying the saved energy in MWh to calculate the value of parameter 0178 SAVED CO2 (reduction on carbon dioxide emissions in tn).</p>
4508	<p><b>PUMP POWER</b></p> <p>Pump power (as a percentage of the nominal motor power) when connected directly to supply (DOL).</p> <ul style="list-style-type: none"> <li>Used for reference when energy savings are calculated.</li> <li>See parameters 0174 SAVED KWH, 0175 SAVED MWH, 0176 SAVED AMOUNT 1, 0177 SAVED AMOUNT 2 and 0178 SAVED CO2.</li> <li>It is possible to use this parameter as the reference power also for other applications than pumps. The reference power can also be some other constant power than a motor connected directly online.</li> </ul>
4509	<p><b>ENERGY RESET</b></p> <p>Resets energy calculators 0174 SAVED KWH, 0175 SAVED MWH, 0176 SAVED AMOUNT 1, 0177 SAVED AMOUNT 2 and 0178 SAVED CO2.</p>

**Group 50: ENCODER**

This group defines the setup for encoder use:

- Sets the number of encoder pulses per shaft revolution.
- Enables the encoder operation.
- Defines how mechanical angle and revolution data is reset.

See also *User's Manual for Pulse Encoder Interface Module OTAC-01* (3AUA0000001938 [English]).

Code	Description
5001	<p><b>PULSE NR</b></p> <p>Sets the number of pulses provided by an optional encoder for each full motor shaft revolution (ppr).</p>
5002	<p><b>ENCODER ENABLE</b></p> <p>Enables/disables an optional encoder.</p> <p>0 = DISABLE – Drive uses speed feedback derived from the internal motor model (applies for any setting of parameter 9904 MOTOR CTRL MODE).</p> <p>1 = ENABLE – Drive uses feedback from an optional encoder. This function requires the Pulse Encoder Interface Module (OTAC-01) and an encoder. Operation depends on the setting of parameter 9904 MOTOR CTRL MODE:</p> <ul style="list-style-type: none"> <li>• 9904 = 1 (VECTOR:SPEED): The encoder provides improved speed feedback and improved low speed torque accuracy.</li> <li>• 9904 = 2 (VECTOR:TORQ): The encoder provides improved speed feedback and improved low speed torque accuracy.</li> <li>• 9904 = 3 (SCALAR:SPEED): The encoder provides speed feedback. (This is not closed loop speed regulation. However, using parameter 2608 SLIP COMP RATIO and an encoder improves steady state speed accuracy.)</li> </ul>
5003	<p><b>ENCODER FAULT</b></p> <p>Defines the drive operation if a failure is detected in communication between the encoder and the encoder interface module, or between the module and the drive.</p> <p>1 = FAULT – The drive generates fault ENCODER ERR, and the motor coasts to a stop.</p> <p>2 = ALARM – The drive generates alarm ENCODER ERR and operates as if parameter 5002 ENCODER ENABLE = 0 (DISABLE), that is, speed feedback is derived from the internal motor model.</p>
5010	<p><b>Z PLS ENABLE</b></p> <p>Enables/disables the use of an encoder's Z-pulse to define the motor shaft's zero position. When enabled, a Z-pulse input resets parameter 0146 MECH ANGLE to zero to define the shaft's zero position. This function requires an encoder that provides Z-pulse signals.</p> <p>0 = DISABLE – Z-pulse input is not present or ignored if present.</p> <p>1 = ENABLE – A Z-pulse input resets parameter 0146 MECH ANGLE to zero.</p>
5011	<p><b>POSITION RESET</b></p> <p>Resets the encoder's position feedback. This parameter is self-clearing.</p> <p>0 = DISABLE – Inactive.</p> <p>1 = ENABLE – Resets the encoder position feedback. Parameters reset depends on the state of parameter 5010 Z PLS ENABLE:</p> <ul style="list-style-type: none"> <li>• 5010 = 0 (DISABLE) – Reset applies to parameters 0147 MECH REVS and 0146 MECH ANGLE.</li> <li>• 5010 = 1 (ENABLE) – Reset applies only to parameter 0147 MECH REVS.</li> </ul>

## Group 51: EXT COMM MODULE

This group defines set-up variables for a fieldbus adapter (FBA) communication module. For more information on these parameters, refer to the user's manual supplied with the FBA module.

Code	Description
5101	<p><b>FBA TYPE</b></p> <p>Displays the type of the connected fieldbus adapter module.</p> <p>0 = NOT DEFINED – Module not found, or not properly connected, or parameter 9802 is not set to 4 (EXT FBA).</p> <p>1 = PROFIBUS-DP</p> <p>21 = LONWORKS</p> <p>32 = CANopen</p> <p>37 = DEVICENET</p> <p>101 = CONTROLNET</p> <p>128 = ETHERNET</p> <p>132 = PROFINET</p> <p>135 = EtherCAT</p> <p>136 = EPL – Ethernet POWERLINK</p>
5102 ... 5126	<p><b>FB PAR 2...FB PAR 26</b></p> <p>Refer to communication module documentation for more information on these parameters.</p>
5127	<p><b>FBA PAR REFRESH</b></p> <p>Validates any changed fieldbus parameter settings.</p> <p>0 = DONE – Refreshing done.</p> <p>1 = REFRESH – Refreshing.</p> <ul style="list-style-type: none"> <li>• After refreshing, the value reverts automatically to DONE.</li> </ul>
5128	<p><b>FILE CPI FW REV</b></p> <p>Displays the CPI firmware revision of the drive's fieldbus adapter configuration file. Format is xyz where:</p> <ul style="list-style-type: none"> <li>• x = major revision number</li> <li>• y = minor revision number</li> <li>• z = correction number</li> </ul> <p><b>Example:</b> 107 = revision 1.07</p>
5129	<p><b>FILE CONFIG ID</b></p> <p>Displays the revision of the drive's fieldbus adapter module's configuration file identification.</p> <ul style="list-style-type: none"> <li>• File configuration information is drive application program-dependent.</li> </ul>
5130	<p><b>FILE CONFIG REV</b></p> <p>Contains the revision of the drive's fieldbus adapter module configuration file.</p> <p><b>Example:</b> 1 = revision 1</p>
5131	<p><b>FBA STATUS</b></p> <p>Contains the status of the adapter module.</p> <p>0 = IDLE – Adapter not configured.</p> <p>1 = EXECUT INIT – Adapter is initializing.</p> <p>2 = TIME OUT – A timeout has occurred in the communication between the adapter and the drive.</p> <p>3 = CONFIG ERROR – Adapter configuration error.</p> <ul style="list-style-type: none"> <li>• The revision code of the adapter's CPI firmware revision is older than required CPI firmware version defined in the drive's configuration file (parameter 5132 &lt; 5128).</li> </ul> <p>4 = OFF-LINE – Adapter is off-line.</p> <p>5 = ON-LINE – Adapter is on-line.</p> <p>6 = RESET – Adapter is performing a hardware reset.</p>
5132	<p><b>FBA CPI FW REV</b></p> <p>Contains the revision of the module's CPI program. Format is xyz where:</p> <ul style="list-style-type: none"> <li>• x = major revision number</li> <li>• y = minor revision number</li> <li>• z = correction number</li> </ul> <p><b>Example:</b> 107 = revision 1.07</p>
5133	<p><b>FBA APPL FW REV</b></p> <p>Contains the revision of the module's application program. Format is xyz (see parameter 5132).</p>

**Group 52: PANEL COMM**

This group defines the communication settings for the control panel port on the drive. Normally, when using the supplied control panel, there is no need to change settings in this group.

In this group, parameter modifications take effect on the next power-up.

Code	Description
5201	<b>STATION ID</b> Defines the address of the drive. <ul style="list-style-type: none"> <li>• Two units with the same address are not allowed on-line.</li> <li>• Range: 1...247</li> </ul>
5202	<b>BAUD RATE</b> Defines the communication speed of the drive in kbits per second (kb/s). 9.6 kb/s 19.2 kb/s 38.4 kb/s 57.6 kb/s 115.2 kb/s
5203	<b>PARITY</b> Sets the character format to be used with the panel communication. 0 = 8 NONE 1 – 8 data bits, no parity, one stop bit. 1 = 8 NONE 2 – 8 data bits, no parity, two stop bits. 2 = 8 EVEN 1 – 8 data bits, even parity, one stop bit. 3 = 8 ODD 1 – 8 data bits, odd parity, one stop bit.
5204	<b>OK MESSAGES</b> Contains a count of valid Modbus messages received by the drive. <ul style="list-style-type: none"> <li>• During normal operation, this counter is increasing constantly.</li> </ul>
5205	<b>PARITY ERRORS</b> Contains a count of the characters with a parity error that is received from the bus. For high counts, check: <ul style="list-style-type: none"> <li>• Parity settings of devices connected on the bus – they must not differ.</li> <li>• Ambient electro-magnetic noise levels – high noise levels generate errors.</li> </ul>
5206	<b>FRAME ERRORS</b> Contains a count of the characters with a framing error that the bus receives. For high counts, check: <ul style="list-style-type: none"> <li>• Communication speed settings of devices connected on the bus – they must not differ.</li> <li>• Ambient electro-magnetic noise levels – high noise levels generate errors.</li> </ul>
5207	<b>BUFFER OVERRUNS</b> Contains a count of the characters received that cannot be placed in the buffer. <ul style="list-style-type: none"> <li>• Longest possible message length for the drive is 128 bytes.</li> <li>• Received messages exceeding 128 bytes overflow the buffer. The excess characters are counted.</li> </ul>
5208	<b>CRC ERRORS</b> Contains a count of the messages with a CRC error that the drive receives. For high counts, check: <ul style="list-style-type: none"> <li>• Ambient electro-magnetic noise levels – high noise levels generate errors.</li> <li>• CRC calculations for possible errors.</li> </ul>

### Group 53: EFB PROTOCOL

This group defines set-up variables used for an embedded fieldbus (EFB) communication protocol. The standard EFB protocol in the ACS550 is Modbus. See chapter [Embedded fieldbus](#) page 203.

Code	Description
5301	<b>EFB PROTOCOL ID</b> Contains the identification and program revision of the protocol. • Format: XYY, where xx = protocol ID, and YY = program revision.
5302	<b>EFB STATION ID</b> Defines the node address of the RS485 link. • The node address on each unit must be unique.
5303	<b>EFB BAUD RATE</b> Defines the communication speed of the RS485 link in kbits per second (kb/s). 1.2 kb/s 2.4 kb/s 4.8 kb/s 9.6 kb/s 19.2 kb/s 38.4 kb/s 57.6 kb/s 76.8 kb/s
5304	<b>EFB PARITY</b> Defines the data length, parity and stop bits to be used with the RS485 link communication. • The same settings must be used in all on-line stations. 0 = 8 NONE 1 – 8 data bits, no parity, one stop bit. 1 = 8 NONE 2 – 8 data bits, no parity, two stop bits. 2 = 8 EVEN 1 – 8 data bits, even parity, one stop bit. 3 = 8 ODD 1 – 8 data bits, odd parity, one stop bit.
5305	<b>EFB CTRL PROFILE</b> Selects the communication profile used by the EFB protocol. 0 = ABB DRV LIM – Operation of Control/Status Words conforms to ABB Drives Profile, as used in ACS400. 1 = DCU PROFILE – Operation of Control/Status Words conforms to 32-bit DCU Profile. 2 = ABB DRV FULL – Operation of Control/Status Words conforms to ABB Drives Profile, as used in ACS600/800.
5306	<b>EFB OK MESSAGES</b> Contains a count of valid messages received by the drive. • During normal operation, this counter is increasing constantly.
5307	<b>EFB CRC ERRORS</b> Contains a count of the messages with a CRC error received by the drive. For high counts, check: • Ambient electro-magnetic noise levels – high noise levels generate errors. • CRC calculations for possible errors.
5308	<b>EFB UART ERRORS</b> Contains a count of the messages with a character error received by the drive.
5309	<b>EFB STATUS</b> Contains the status of the EFB protocol. 0 = IDLE – EFB protocol is configured, but not receiving any messages. 1 = EXECUT INIT – EFB protocol is initializing. 2 = TIME OUT – A timeout has occurred in the communication between the network master and the EFB protocol. 3 = CONFIG ERROR – EFB protocol has a configuration error. 4 = OFF-LINE – EFB protocol is receiving messages that are NOT addressed to this drive. 5 = ON-LINE – EFB protocol is receiving messages that are addressed to this drive. 6 = RESET – EFB protocol is performing a hardware reset. 7 = LISTEN ONLY – EFB protocol is in listen-only mode.
5310	<b>EFB PAR 10</b> Specifies the parameter mapped to Modbus Register 40005.



<b>Code</b>	<b>Description</b>
5311	<b>EFB PAR 11</b> Specifies the parameter mapped to Modbus Register 40006.
5312	<b>EFB PAR 12</b> Specifies the parameter mapped to Modbus Register 40007.
5313	<b>EFB PAR 13</b> Specifies the parameter mapped to Modbus Register 40008.
5314	<b>EFB PAR 14</b> Specifies the parameter mapped to Modbus Register 40009.
5315	<b>EFB PAR 15</b> Specifies the parameter mapped to Modbus Register 40010.
5316	<b>EFB PAR 16</b> Specifies the parameter mapped to Modbus Register 40011.
5317	<b>EFB PAR 17</b> Specifies the parameter mapped to Modbus Register 40012.
5318	<b>EFB PAR 18</b> For Modbus: Sets additional delay in milliseconds before the ACS550 begins transmitting response to the master request.
5319	<b>EFB PAR 19</b> ABB Drives profile (ABB DRV LIM or ABB DRV FULL) Control Word. Read only copy of the Fieldbus Control Word.
5320	<b>EFB PAR 20</b> ABB Drives profile (ABB DRV LIM or ABB DRV FULL) Status Word. Read only copy of the Fieldbus Status Word.

## Group 64: LOAD ANALYZER

This group defines the load analyzer, which can be used for analyzing the customer's process and sizing the drive and the motor.

The peak value is logged at 2 ms level, and the distribution loggers are updated on 0.2 s (200 ms) time level. Three different values can be logged.

1. Amplitude logger 1: The measured current is logged continuously. The distribution as a percentage of the nominal current  $I_{2N}$  is shown in ten classes.
2. Peak value logger: One signal in group 1 can be logged for the peak (maximum) value. The peak value of the signal, peak time (time when the peak value was detected) as well the frequency, current and DC voltage at the peak time are shown.
3. Amplitude logger 2: One signal in group 1 can be logged for amplitude distribution. The base value (100% value) can be set by the user.

The first logger cannot be reset. The other two loggers can be reset by a user-defined method. They are also reset if either of the signals or the peak value filter time is changed.

Code	Description
6401	<b>PVL SIGNAL</b> Defines (by number) the signal logged for the peak value. <ul style="list-style-type: none"> <li>• Any parameter number in <a href="#">Group 01: OPERATING DATA</a> can be selected. Eg 102 = parameter 0102 SPEED.</li> </ul> 100 = NOT SELECTED – No signal (parameter) logged for the peak value. 101...178 – Logs parameter 0101...0178.
6402	<b>PVL FILTER TIME</b> Defines the filter time for peak value logging. <ul style="list-style-type: none"> <li>• 0.0...120.0 – Filter time (seconds).</li> </ul>
6403	<b>LOGGERS RESET</b> Defines the source for the reset of peak value logger and amplitude logger 2. <ul style="list-style-type: none"> <li>0 = NOT SEL – No reset selected.</li> <li>1 = DI1 – Reset loggers on the rising edge of digital input DI1.</li> <li>2...6 = DI2...DI6 – Reset loggers on the rising edge of digital input DI2...DI6.</li> <li>7 = RESET – Reset loggers. Parameter is set to NOT SEL.</li> <li>-1 = DI1(INV) – Reset loggers on the falling edge of digital input DI1.</li> <li>-2...-6 = DI2(INV) ...DI6(INV) – Reset loggers on the falling edge of digital input DI2...DI6.</li> </ul>
6404	<b>AL2 SIGNAL</b> Defines the signal logged for amplitude logger 2. <ul style="list-style-type: none"> <li>• Any parameter number in <a href="#">Group 01: OPERATING DATA</a> can be selected. Eg 102 = parameter 0102 SPEED.</li> </ul> 100 = NOT SELECTED – No signal (parameter) logged for amplitude distribution (amplitude logger 2). 101...178 – Logs parameter 0101...0178.
6405	<b>AL2 SIGNAL BASE</b> Defines the base value from which the percentage distribution is calculated. <ul style="list-style-type: none"> <li>• Representation and default value depends on the signal selected with parameter 6404 AL2 SIGNAL.</li> </ul>
6406	<b>PEAK VALUE</b> Detected peak value of the signal selected with parameter 6401 PVL SIGNAL.
6407	<b>PEAK TIME 1</b> Date of the peak value detection. <ul style="list-style-type: none"> <li>• Format: Date if the real time clock is operating (dd.mm.yy). / The number of days elapsed after the power-on if the real time clock is not used, or was not set (xx d).</li> </ul>
6408	<b>PEAK TIME 2</b> Time of the peak value detection. <ul style="list-style-type: none"> <li>• Format: hours:minutes:seconds.</li> </ul>

Code	Description
6409	<b>CURRENT AT PEAK</b> Current at the moment of the peak value (amperes).
6410	<b>UDC AT PEAK</b> DC voltage at the moment of the peak value (volts).
6411	<b>FREQ AT PEAK</b> Output frequency at the moment of the peak value (herzes).
6412	<b>TIME OF RESET 1</b> Last reset date of the peak logger and amplitude logger 2. • Format: Date if the real time clock is operating (dd.mm.yy). / The number of days elapsed after the power-on if the real time clock is not used, or was not set (xx d).
6413	<b>TIME OF RESET 2</b> Last reset time of the peak logger and amplitude logger 2. • Format: hours:minutes:seconds.
6414	<b>AL1RANGE0TO10</b> Amplitude logger 1 (current in percent of nominal current $I_{2N}$ ) 0...10% distribution.
6415	<b>AL1RANGE10TO20</b> Amplitude logger 1 (current in percent of nominal current $I_{2N}$ ) 10...20% distribution.
6416	<b>AL1RANGE20TO30</b> Amplitude logger 1 (current in percent of nominal current $I_{2N}$ ) 20...30% distribution.
6417	<b>AL1RANGE30TO40</b> Amplitude logger 1 (current in percent of nominal current $I_{2N}$ ) 30...40% distribution.
6418	<b>AL1RANGE40TO50</b> Amplitude logger 1 (current in percent of nominal current $I_{2N}$ ) 40...50% distribution.
6419	<b>AL1RANGE50TO60</b> Amplitude logger 1 (current in percent of nominal current $I_{2N}$ ) 50...60% distribution.
6420	<b>AL1RANGE60TO70</b> Amplitude logger 1 (current in percent of nominal current $I_{2N}$ ) 60...70% distribution.
6421	<b>AL1RANGE70TO80</b> Amplitude logger 1 (current in percent of nominal current $I_{2N}$ ) 70...80% distribution.
6422	<b>AL1RANGE80TO90</b> Amplitude logger 1 (current in percent of nominal current $I_{2N}$ ) 80...90% distribution.
6423	<b>AL1RANGE90TO</b> Amplitude logger 1 (current in percent of nominal current $I_{2N}$ ) over 90% distribution.
6424	<b>AL2RANGE0TO10</b> Amplitude logger 2 (signal selection with parameter 6404) 0...10% distribution.
6425	<b>AL2RANGE10TO20</b> Amplitude logger 2 (signal selection with parameter 6404) 10...20% distribution.
6426	<b>AL2RANGE20TO30</b> Amplitude logger 2 (signal selection with parameter 6404) 20...30% distribution.
6427	<b>AL2RANGE30TO40</b> Amplitude logger 2 (signal selection with parameter 6404) 30...40% distribution.
6428	<b>AL2RANGE40TO50</b> Amplitude logger 2 (signal selection with parameter 6404) 40...50% distribution.
6429	<b>AL2RANGE50TO60</b> Amplitude logger 2 (signal selection with parameter 6404) 50...60% distribution.
6430	<b>AL2RANGE60TO70</b> Amplitude logger 2 (signal selection with parameter 6404) 60...70% distribution.
6431	<b>AL2RANGE70TO80</b> Amplitude logger 2 (signal selection with parameter 6404) 70...80% distribution.

Code	Description
6432	<b>AL2RANGE80TO90</b> Amplitude logger 2 (signal selection with parameter 6404) 80...90% distribution.
6433	<b>AL2RANGE90TO</b> Amplitude logger 2 (signal selection with parameter 6404) over 90% distribution.

**Group 81: PFC CONTROL**

This group defines a Pump-Fan Control (PFC) mode of operation. The major features of PFC control are:

- The ACS550 controls the motor of pump no. 1, varying the motor speed to control the pump capacity. This motor is the speed regulated motor.
- Direct line connections power the motor of pump no. 2 and pump no.3, etc. The ACS550 switches pump no. 2 (and then pump no. 3, etc.) on and off as needed. These motors are auxiliary motors.
- The ACS550 PID control uses two signals: a process reference and an actual value feedback. The PID controller adjusts the speed (frequency) of the first pump such that the actual value follows the process reference.
- When demand (defined by the process reference) exceeds the first motor's capacity (user defined as a frequency limit), the PFC control automatically starts an auxiliary pump. The PFC also reduces the speed of the first pump to account for the auxiliary pump's addition to total output. Then, as before, the PID controller adjusts the speed (frequency) of the first pump such that the actual value follows the process reference. If demand continues to increase, PFC adds additional auxiliary pumps, using the same process.
- When demand drops, such that the first pump speed falls below a minimum limit (user defined by a frequency limit), the PFC control automatically stops an auxiliary pump. The PFC also increases the speed of the first pump to account for the auxiliary pump's missing output.
- An Interlock function (when enabled) identifies off-line (out of service) motors, and the PFC control skips to the next available motor in the sequence.
- An Autochange function (when enabled and with the appropriate switchgear) equalizes duty time between the pump motors. Autochange periodically increments the position of each motor in the rotation – the speed regulated motor becomes the last auxiliary motor, the first auxiliary motor becomes the speed regulated motor, etc.

Code	Description
8103	<p><b>REFERENCE STEP 1</b></p> <p>Sets a percentage value that is added to the process reference.</p> <ul style="list-style-type: none"> <li>• Applies only when <u>at least one</u> auxiliary (constant speed) motor is running.</li> <li>• Default value is 0%.</li> </ul> <p><b>Example:</b> An ACS550 operates three parallel pumps that maintain water pressure in a pipe.</p> <ul style="list-style-type: none"> <li>• 4011 INTERNAL SETPNT sets a constant pressure reference that controls the pressure in the pipe.</li> <li>• The speed regulated pump operates alone at low water consumption levels.</li> <li>• As water consumption increases, first one constant speed pump operates, then, the second.</li> <li>• As flow increases, the pressure at the output end of the pipe drops relative to the pressure measured at the input end. As auxiliary motors step in to increase the flow, the adjustments below correct the reference to more closely match the output pressure.</li> <li>• When the first auxiliary pump operates, increase the reference with parameter 8103 REFERENCE STEP 1.</li> <li>• When two auxiliary pumps operate, increase the reference with parameter 8103 REFERENCE STEP 1 + parameter 8104 REFERENCE STEP 2.</li> <li>• When three auxiliary pumps operate, increase the reference with parameter 8103 REFERENCE STEP 1 + parameter 8104 REFERENCE STEP 2 + parameter 8105 REFERENCE STEP 3.</li> </ul>

Code	Description
8104	<p><b>REFERENCE STEP 2</b></p> <p>Sets a percentage value that is added to the process reference.</p> <ul style="list-style-type: none"> <li>• Applies only when <u>at least two</u> auxiliary (constant speed) motors are running.</li> <li>• See parameter 8103 REFERENCE STEP 1.</li> </ul>
8105	<p><b>REFERENCE STEP 3</b></p> <p>Sets a percentage value that is added to the process reference.</p> <ul style="list-style-type: none"> <li>• Applies only when <u>at least three</u> auxiliary (constant speed) motors are running.</li> <li>• See parameter 8103 REFERENCE STEP 1.</li> </ul>
8109	<p><b>START FREQ 1</b></p> <p>Sets the frequency limit used to start the first auxiliary motor. The first auxiliary motor starts if:</p> <ul style="list-style-type: none"> <li>• No auxiliary motors are running.</li> <li>• ACS550 output frequency exceeds the limit: <math>8109 + 1</math> Hz.</li> <li>• Output frequency stays above a relaxed limit (<math>8109 - 1</math> Hz) for at least the time: 8115 AUX MOT START D.</li> </ul> <p>After the first auxiliary motor starts:</p> <ul style="list-style-type: none"> <li>• Output frequency decreases by the value = <math>(8109 \text{ START FREQ } 1) - (8112 \text{ LOW FREQ } 1)</math>.</li> <li>• In effect, the output of the speed regulated motor drops to compensate for the input from the auxiliary motor.</li> </ul> <p>See the figure, where:</p> <ul style="list-style-type: none"> <li>• A = <math>(8109 \text{ START FREQ } 1) - (8112 \text{ LOW FREQ } 1)</math></li> <li>• B = Output frequency increase during the start delay.</li> <li>• C = Diagram showing auxiliary motor's run status as frequency increases (1 = On).</li> </ul> <p><b>Note:</b> 8109 START FREQ 1 value must be between:</p> <ul style="list-style-type: none"> <li>• 8112 LOW FREQ 1</li> <li>• <math>(2008 \text{ MAXIMUM FREQ}) - 1</math>.</li> </ul>
8110	<p><b>START FREQ 2</b></p> <p>Sets the frequency limit used to start the second auxiliary motor.</p> <ul style="list-style-type: none"> <li>• See 8109 START FREQ 1 for a complete description of the operation.</li> </ul> <p>The second auxiliary motor starts if:</p> <ul style="list-style-type: none"> <li>• One auxiliary motor is running.</li> <li>• ACS550 output frequency exceeds the limit: <math>8110 + 1</math>.</li> <li>• Output frequency stays above the relaxed limit (<math>8110 - 1</math> Hz) for at least the time: 8115 AUX MOT START D.</li> </ul>
8111	<p><b>START FREQ 3</b></p> <p>Sets the frequency limit used to start the third auxiliary motor.</p> <ul style="list-style-type: none"> <li>• See 8109 START FREQ 1 for a complete description of the operation.</li> </ul> <p>The third auxiliary motor starts if:</p> <ul style="list-style-type: none"> <li>• Two auxiliary motors are running.</li> <li>• ACS550 output frequency exceeds the limit: <math>8111 + 1</math> Hz.</li> <li>• Output frequency stays above the relaxed limit (<math>8111 - 1</math> Hz) for at least the time: 8115 AUX MOT START D.</li> </ul>

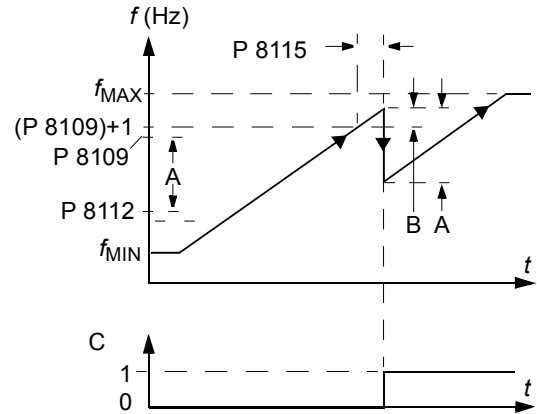

Code	Description
8112	<p><b>LOW FREQ 1</b></p> <p>Sets the frequency limit used to stop the first auxiliary motor. The first auxiliary motor stops if:</p> <ul style="list-style-type: none"> <li>• Only one (the first) auxiliary motor is running.</li> <li>• ACS550 output frequency drops below the limit: 8112 - 1.</li> <li>• Output frequency stays below the relaxed limit (8112 + 1 Hz) for at least the time: 8116 AUX MOT STOP D.</li> </ul> <p>After the first auxiliary motor stops:</p> <ul style="list-style-type: none"> <li>• Output frequency increases by the value = (8109 START FREQ 1) - (8112 LOW FREQ 1).</li> <li>• In effect, the output of the speed regulated motor increases to compensate for the loss of the auxiliary motor.</li> </ul> <p>See the figure, where:</p> <ul style="list-style-type: none"> <li>• A = (8109 START FREQ 1) - (8112 LOW FREQ 1)</li> <li>• B = Output frequency decrease during the stop delay.</li> <li>• C = Diagram showing auxiliary motor's run status as frequency decreases (1 = On).</li> <li>• Grey path = Shows hysteresis – if time is reversed, the path backwards is not the same. For details on the path for starting, see the diagram at 8109 START FREQ 1.</li> </ul> <p><b>Note:</b> 8112 LOW FREQ 1 value must be between:</p> <ul style="list-style-type: none"> <li>• (2007 MINIMUM FREQ) + 1.</li> <li>• 8109 START FREQ 1</li> </ul>
8113	<p><b>LOW FREQ 2</b></p> <p>Sets the frequency limit used to stop the second auxiliary motor.</p> <ul style="list-style-type: none"> <li>• See 8112 LOW FREQ 1 for a complete description of the operation.</li> </ul> <p>The second auxiliary motor stops if:</p> <ul style="list-style-type: none"> <li>• Two auxiliary motors are running.</li> <li>• ACS550 output frequency drops below the limit: 8113 - 1.</li> <li>• Output frequency stays below the relaxed limit (8113 + 1 Hz) for at least the time: 8116 AUX MOT STOP D.</li> </ul>
8114	<p><b>LOW FREQ 3</b></p> <p>Sets the frequency limit used to stop the third auxiliary motor.</p> <ul style="list-style-type: none"> <li>• See 8112 LOW FREQ 1 for a complete description of the operation.</li> </ul> <p>The third auxiliary motor stops if:</p> <ul style="list-style-type: none"> <li>• Three auxiliary motors are running.</li> <li>• ACS550 output frequency drops below the limit: 8114 - 1.</li> <li>• Output frequency stays below the relaxed limit (8114 + 1 Hz) for at least the time: 8116 AUX MOT STOP D.</li> </ul>
8115	<p><b>AUX MOT START D</b></p> <p>Sets the Start Delay for the auxiliary motors.</p> <ul style="list-style-type: none"> <li>• The output frequency must remain above the start frequency limit (parameter 8109, 8110, or 8111) for this time period before the auxiliary motor starts.</li> <li>• See 8109 START FREQ 1 for a complete description of the operation.</li> </ul>
8116	<p><b>AUX MOT STOP D</b></p> <p>Sets the Stop Delay for the auxiliary motors.</p> <ul style="list-style-type: none"> <li>• The output frequency must remain below the low frequency limit (parameter 8112, 8113, or 8114) for this time period before the auxiliary motor stops.</li> <li>• See 8112 LOW FREQ 1 for a complete description of the operation.</li> </ul>

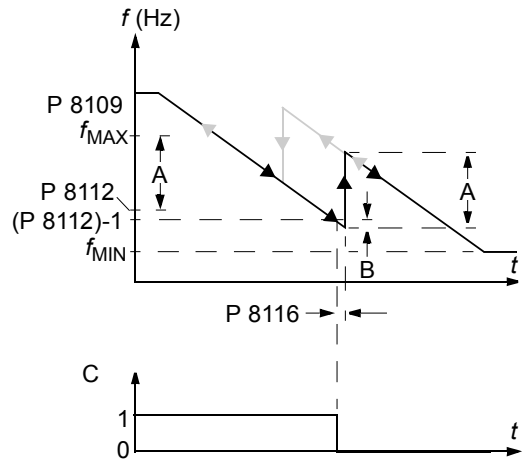

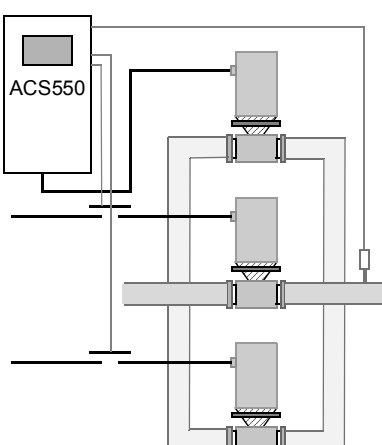
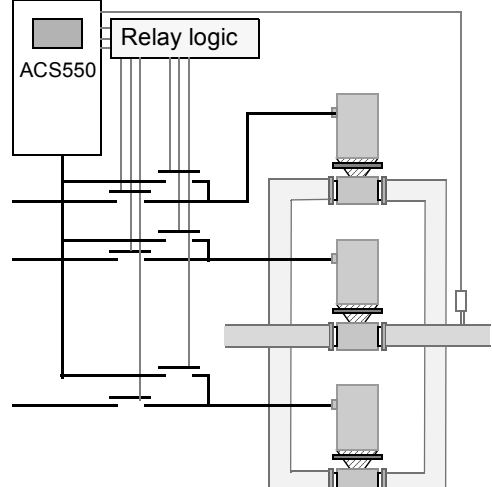
Code	Description
8117	<p><b>NR OF AUX MOT</b></p> <p>Sets the number of auxiliary motors.</p> <ul style="list-style-type: none"> <li>• Each auxiliary motor requires a relay output, which the drive uses to send start/stop signals.</li> <li>• The Autochange function, if used, requires an additional relay output for the speed regulated motor.</li> <li>• The following describes the set-up of the required relay outputs.</li> </ul> <p><b>Relay outputs</b></p> <p>As noted above, each auxiliary motor requires a relay output, which the drive uses to send start/stop signals. The following describes how the drive keeps track of motors and relays.</p> <ul style="list-style-type: none"> <li>• The ACS550 provides relay outputs RO1...RO3.</li> <li>• An external digital output module (OREL-01) can be added to provide relay outputs RO4...RO6.</li> <li>• Parameters 1401...1403 and 1410...1412 define, respectively, how relays RO1...RO6 are used – the parameter value 31 PFC defines the relay as used for PFC.</li> <li>• The ACS550 assigns auxiliary motors to relays in ascending order. If the Autochange function is disabled, the first auxiliary motor is the one connected to the first relay with a parameter setting = 31 PFC, and so on. If the Autochange function is used, the assignments rotate. Initially, the speed regulated motor is the one connected to the first relay with a parameter setting = 31 PFC, the first auxiliary motor is the one connected to the second relay with a parameter setting = 31 PFC, and so on.</li> </ul> <div style="display: flex; justify-content: space-around; align-items: flex-start;"> <div style="text-align: center;">  <p>Standard PFC mode</p> </div> <div style="text-align: center;">  <p>PFC with Autochange mode</p> </div> </div> <ul style="list-style-type: none"> <li>• The fourth auxiliary motor uses the same reference step, low frequency and start frequency values as the third auxiliary motor.</li> </ul>



Code	Description																																																																																																																																																																																																																																														
	<ul style="list-style-type: none"> <li>The table below shows the ACS550 PFC motor assignments for some typical settings in the Relay Output parameters (1401...1403 and 1410...1412), where the settings are either =31 (PFC), or =X (anything but 31), and where the Autochange function is disabled (8118 AUTOCHNG INTERV = 0.0).</li> </ul> <table border="1"> <thead> <tr> <th colspan="8">Parameter setting</th> <th colspan="6">ACS550 Relay assignment</th> </tr> <tr> <th>1</th><th>4</th><th>0</th><th>1</th><th>1</th><th>1</th><th>1</th><th>8</th> <th colspan="6">Autochange disabled</th> </tr> <tr> <th>1</th><th>2</th><th>3</th><th>0</th><th>1</th><th>1</th><th>1</th><th>2</th> <th>RO1</th><th>RO2</th><th>RO3</th><th>RO4</th><th>RO5</th><th>RO6</th> </tr> </thead> <tbody> <tr> <td>31</td><td>X</td><td>X</td><td>X</td><td>X</td><td>X</td><td>X</td><td>1</td> <td>Aux.</td><td>X</td><td>X</td><td>X</td><td>X</td><td>X</td> </tr> <tr> <td>31</td><td>31</td><td>X</td><td>X</td><td>X</td><td>X</td><td>X</td><td>2</td> <td>Aux.</td><td>Aux.</td><td>X</td><td>X</td><td>X</td><td>X</td> </tr> <tr> <td>31</td><td>31</td><td>31</td><td>X</td><td>X</td><td>X</td><td>X</td><td>3</td> <td>Aux.</td><td>Aux.</td><td>Aux.</td><td>X</td><td>X</td><td>X</td> </tr> <tr> <td>X</td><td>31</td><td>31</td><td>X</td><td>X</td><td>X</td><td>X</td><td>2</td> <td>X</td><td>Aux.</td><td>Aux.</td><td>X</td><td>X</td><td>X</td> </tr> <tr> <td>X</td><td>X</td><td>X</td><td>31</td><td>X</td><td>31</td><td>X</td><td>2</td> <td>X</td><td>X</td><td>X</td><td>Aux.</td><td>X</td><td>Aux.</td> </tr> <tr> <td>31</td><td>31</td><td>X</td><td>X</td><td>X</td><td>X</td><td>X</td><td>1*</td> <td>Aux.</td><td>Aux.</td><td>X</td><td>X</td><td>X</td><td>X</td> </tr> </tbody> </table> <p>* = One additional relay output for the PFC that is in use. One motor is in "sleep" when the other is rotating.</p> <ul style="list-style-type: none"> <li>The table below shows the ACS550 PFC motor assignments for some typical settings in the Relay Output parameters (1401...1403 and 1410...1412), where the settings are either =31 (PFC), or =X (anything but 31), and where the Autochange function is enabled (8118 AUTOCHNG INTERV = value &gt; 0.0).</li> </ul> <table border="1"> <thead> <tr> <th colspan="8">Parameter setting</th> <th colspan="6">ACS550 Relay assignment</th> </tr> <tr> <th>1</th><th>4</th><th>0</th><th>1</th><th>1</th><th>1</th><th>1</th><th>8</th> <th colspan="6">Autochange enabled</th> </tr> <tr> <th>1</th><th>2</th><th>3</th><th>0</th><th>1</th><th>1</th><th>1</th><th>7</th> <th>RO1</th><th>RO2</th><th>RO3</th><th>RO4</th><th>RO5</th><th>RO6</th> </tr> </thead> <tbody> <tr> <td>31</td><td>31</td><td>X</td><td>X</td><td>X</td><td>X</td><td>X</td><td>1</td> <td>PFC</td><td>PFC</td><td>X</td><td>X</td><td>X</td><td>X</td> </tr> <tr> <td>31</td><td>31</td><td>31</td><td>X</td><td>X</td><td>X</td><td>X</td><td>2</td> <td>PFC</td><td>PFC</td><td>PFC</td><td>X</td><td>X</td><td>X</td> </tr> <tr> <td>X</td><td>31</td><td>31</td><td>X</td><td>X</td><td>X</td><td>X</td><td>1</td> <td>X</td><td>PFC</td><td>PFC</td><td>X</td><td>X</td><td>X</td> </tr> <tr> <td>X</td><td>X</td><td>X</td><td>31</td><td>X</td><td>31</td><td>X</td><td>1</td> <td>X</td><td>X</td><td>X</td><td>PFC</td><td>X</td><td>PFC</td> </tr> <tr> <td>31</td><td>31</td><td>X</td><td>X</td><td>X</td><td>X</td><td>X</td><td>0**</td> <td>PFC</td><td>PFC</td><td>X</td><td>X</td><td>X</td><td>X</td> </tr> </tbody> </table> <p>** = No auxiliary motors, but the autochange function is in use. Working as a standard PID-control.</p>	Parameter setting								ACS550 Relay assignment						1	4	0	1	1	1	1	8	Autochange disabled						1	2	3	0	1	1	1	2	RO1	RO2	RO3	RO4	RO5	RO6	31	X	X	X	X	X	X	1	Aux.	X	X	X	X	X	31	31	X	X	X	X	X	2	Aux.	Aux.	X	X	X	X	31	31	31	X	X	X	X	3	Aux.	Aux.	Aux.	X	X	X	X	31	31	X	X	X	X	2	X	Aux.	Aux.	X	X	X	X	X	X	31	X	31	X	2	X	X	X	Aux.	X	Aux.	31	31	X	X	X	X	X	1*	Aux.	Aux.	X	X	X	X	Parameter setting								ACS550 Relay assignment						1	4	0	1	1	1	1	8	Autochange enabled						1	2	3	0	1	1	1	7	RO1	RO2	RO3	RO4	RO5	RO6	31	31	X	X	X	X	X	1	PFC	PFC	X	X	X	X	31	31	31	X	X	X	X	2	PFC	PFC	PFC	X	X	X	X	31	31	X	X	X	X	1	X	PFC	PFC	X	X	X	X	X	X	31	X	31	X	1	X	X	X	PFC	X	PFC	31	31	X	X	X	X	X	0**	PFC	PFC	X	X	X	X
Parameter setting								ACS550 Relay assignment																																																																																																																																																																																																																																							
1	4	0	1	1	1	1	8	Autochange disabled																																																																																																																																																																																																																																							
1	2	3	0	1	1	1	2	RO1	RO2	RO3	RO4	RO5	RO6																																																																																																																																																																																																																																		
31	X	X	X	X	X	X	1	Aux.	X	X	X	X	X																																																																																																																																																																																																																																		
31	31	X	X	X	X	X	2	Aux.	Aux.	X	X	X	X																																																																																																																																																																																																																																		
31	31	31	X	X	X	X	3	Aux.	Aux.	Aux.	X	X	X																																																																																																																																																																																																																																		
X	31	31	X	X	X	X	2	X	Aux.	Aux.	X	X	X																																																																																																																																																																																																																																		
X	X	X	31	X	31	X	2	X	X	X	Aux.	X	Aux.																																																																																																																																																																																																																																		
31	31	X	X	X	X	X	1*	Aux.	Aux.	X	X	X	X																																																																																																																																																																																																																																		
Parameter setting								ACS550 Relay assignment																																																																																																																																																																																																																																							
1	4	0	1	1	1	1	8	Autochange enabled																																																																																																																																																																																																																																							
1	2	3	0	1	1	1	7	RO1	RO2	RO3	RO4	RO5	RO6																																																																																																																																																																																																																																		
31	31	X	X	X	X	X	1	PFC	PFC	X	X	X	X																																																																																																																																																																																																																																		
31	31	31	X	X	X	X	2	PFC	PFC	PFC	X	X	X																																																																																																																																																																																																																																		
X	31	31	X	X	X	X	1	X	PFC	PFC	X	X	X																																																																																																																																																																																																																																		
X	X	X	31	X	31	X	1	X	X	X	PFC	X	PFC																																																																																																																																																																																																																																		
31	31	X	X	X	X	X	0**	PFC	PFC	X	X	X	X																																																																																																																																																																																																																																		
8118	<p><b>AUTOCHNG INTERV</b></p> <p>Controls operation of the Autochange function and sets the interval between changes.</p> <ul style="list-style-type: none"> <li>The Autochange time interval only applies to the time when the speed regulated motor is running.</li> <li>See parameter 8119 AUTOCHNG LEVEL for an overview of the Autochange function.</li> <li>The drive always coasts to stop when autochange is performed.</li> <li>Autochange enabled requires parameter 8120 INTERLOCKS = value &gt; 0.</li> </ul> <p>-0.1 = TEST MODE – Forces the interval to value 36...48 s.                      0.0 = NOT SEL – Disables the Autochange function.                      0.1...336 – The operating time interval (the time when the start signal is on) between automatic motor changes.</p> <p><b>⚠ WARNING!</b> When enabled, the Autochange function requires the interlocks (8120 INTERLOCKS = value &gt; 0) enabled. During autochange the power output is interrupted and the drive coasts to stop, preventing damage to the contacts.</p>	<p>PFC with Autochange mode</p>																																																																																																																																																																																																																																													

Code	Description
8119	<p><b>AUTOCHNG LEVEL</b></p> <p>Sets an upper limit, as a percent of output capacity, for the autochange logic. When the output from the PID/PFC control block exceeds this limit, autochange is prevented. For example, use this parameter to deny autochange when the Pump-Fan system is operating near maximum capacity.</p> <p><b>Autochange overview</b></p> <p>The purpose of the autochange operation is to equalize duty time between multiple motors used in a system. At each autochange operation:</p> <ul style="list-style-type: none"> <li>• A different motor takes a turn connected to the ACS550 output – the speed regulated motor.</li> <li>• The starting order of the other motors rotates.</li> </ul> <p>The Autochange function requires:</p> <ul style="list-style-type: none"> <li>• External switchgear for changing the drive's output power connections.</li> <li>• Parameter 8120 INTERLOCKS = value &gt; 0.</li> </ul> <p>Autochange is performed when:</p> <ul style="list-style-type: none"> <li>• The running time since the previous autochange reaches the time set by 8118 AUTOCHNG INTERV.</li> <li>• The PFC input is below the level set by this parameter, 8119 AUTOCHNG LEVEL.</li> </ul> <p><b>Note:</b> The ACS550 always coasts to stop when autochange is performed.</p> <p>In an autochange, the Autochange function does all of the following (see the figure):</p> <ul style="list-style-type: none"> <li>• Initiates a change when the running time, since the last autochange, reaches 8118 AUTOCHNG INTERV, and PFC input is below limit 8119 AUTOCHNG LEVEL.</li> <li>• Stops the speed regulated motor.</li> <li>• Switches off the contactor of the speed regulated motor.</li> <li>• Increments the starting order counter, to change the starting order for the motors.</li> <li>• Identifies the next motor in line to be the speed regulated motor.</li> <li>• Switches off the above motor's contactor, if the motor was running. Any other running motors are not interrupted.</li> <li>• Switches on the contactor of the new speed regulated motor. The autochange switchgear connects this motor to the ACS550 power output.</li> <li>• Delays motor start for the time 8122 PFC START DELAY.</li> <li>• Starts the speed regulated motor.</li> <li>• Identifies the next constant speed motor in the rotation.</li> <li>• Switches the above motor on, but only if the new speed regulated motor had been running (as a constant speed motor) – This step keeps an equal number of motors running before and after autochange.</li> <li>• Continues with normal PFC operation.</li> </ul> <p><b>Starting order counter</b></p> <p>The operation of the starting-order counter:</p> <ul style="list-style-type: none"> <li>• The relay output parameter definitions (1401...1403 and 1410...1412) establish the initial motor sequence. (The lowest parameter number with a value 31 (PFC) identifies the relay connected to 1PFC, the first motor, and so on.)</li> <li>• Initially, 1PFC = speed regulated motor, 2PFC = 1st auxiliary motor, etc.</li> <li>• The first autochange shifts the sequence to: 2PFC = speed regulated motor, 3PFC = 1st auxiliary motor, ..., 1PFC = last auxiliary motor.</li> <li>• The next autochange shifts the sequence again, and so on.</li> <li>• If the autochange cannot start a needed motor because all inactive motors are interlocked, the drive displays an alarm (2015, PFC I LOCK).</li> <li>• When ACS550 power supply is switched off, the counter preserves the current Autochange rotation positions in permanent memory. When power is restored, the Autochange rotation starts at the position stored in memory.</li> <li>• If the PFC relay configuration is changed (or if the PFC enable value is changed), the rotation is reset. (See the first bullet above.)</li> </ul>

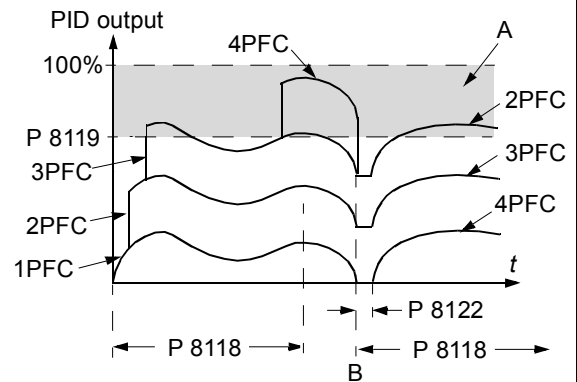

A = Area above 8119 AUTOCHNG LEVEL – autochange not allowed.  
 B = Autochange occurs.  
 1PFC, etc. = PID output associated with each motor.

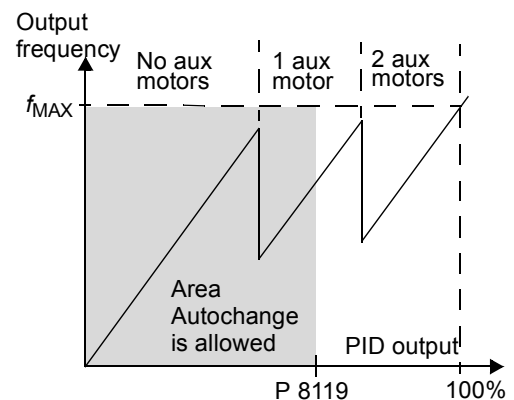

Code	Description																								
8120	<p><b>INTERLOCKS</b></p> <p>Defines operation of the Interlock function. When the Interlock function is enabled:</p> <ul style="list-style-type: none"> <li>• An interlock is active when its command signal is absent.</li> <li>• An interlock is inactive when its command signal is present.</li> <li>• The ACS550 will not start if a start command occurs when the speed regulated motor's interlock is active – the control panel displays an alarm (2015, PFC I LOCK).</li> </ul> <p>Wire each Interlock circuit as follows:</p> <ul style="list-style-type: none"> <li>• Wire a contact of the motor's On/Off switch to the Interlock circuit – the drive's PFC logic can then recognize that the motor is switched off and start the next available motor.</li> <li>• Wire a contact of the motor thermal relay (or other protective device in the motor circuit) to the Interlock input – the drive's PFC logic can then recognize that a motor fault is activated and stop the motor.</li> </ul> <p>0 = NOT SEL – Disables the Interlock function. All digital inputs are available for other purposes.</p> <ul style="list-style-type: none"> <li>• Requires 8118 AUTOCHNG INTERV = 0.0 (The Autochange function must be disabled if Interlock function is disabled.)</li> </ul> <p>1 = DI1 – Enables the Interlock function and assigns a digital input (starting with DI1) to the interlock signal for each PFC relay. These assignments are defined in the following table and depend on:</p> <ul style="list-style-type: none"> <li>• the number of PFC relays [number of parameters 1401...1403 and 1410...1412 with value = 31 (PFC)]</li> <li>• the Autochange function status (disabled if 8118 AUTOCHNG INTERV = 0.0, and otherwise enabled).</li> </ul> <table border="1" style="width: 100%; border-collapse: collapse;"> <thead> <tr> <th style="background-color: #e0e0e0;">No. PFC relays</th> <th style="background-color: #e0e0e0;">Autochange disabled (P 8118)</th> <th style="background-color: #e0e0e0;">Autochange enabled (P 8118)</th> </tr> </thead> <tbody> <tr> <td style="text-align: center;">0</td> <td>DI1: Speed Reg Motor DI2...DI6: Free</td> <td>Not allowed</td> </tr> <tr> <td style="text-align: center;">1</td> <td>DI1: Speed Reg Motor DI2: First PFC Relay DI3...DI6: Free</td> <td>DI1: First PFC Relay DI2...DI6: Free</td> </tr> <tr> <td style="text-align: center;">2</td> <td>DI1: Speed Reg Motor DI2: First PFC Relay DI3: Second PFC Relay DI4...DI6: Free</td> <td>DI1: First PFC Relay DI2: Second PFC Relay DI3...DI6: Free</td> </tr> <tr> <td style="text-align: center;">3</td> <td>DI1: Speed Reg Motor DI2: First PFC Relay DI3: Second PFC Relay DI4: Third PFC Relay DI5...DI6: Free</td> <td>DI1: First PFC Relay DI2: Second PFC Relay DI3: Third PFC Relay DI4...DI6: Free</td> </tr> <tr> <td style="text-align: center;">4</td> <td>DI1: Speed Reg Motor DI2: First PFC Relay DI3: Second PFC Relay DI4: Third PFC Relay DI5: Fourth PFC Relay DI6: Free</td> <td>DI1: First PFC Relay DI2: Second PFC Relay DI3: Third PFC Relay DI4: Fourth PFC Relay DI5...DI6: Free</td> </tr> <tr> <td style="text-align: center;">5</td> <td>DI1: Speed Reg Motor DI2: First PFC Relay DI3: Second PFC Relay DI4: Third PFC Relay DI5: Fourth PFC Relay DI6: Fifth PFC Relay</td> <td>DI1: First PFC Relay DI2: Second PFC Relay DI3: Third PFC Relay DI4: Fourth PFC Relay DI5: Fifth PFC Relay DI6: Free</td> </tr> <tr> <td style="text-align: center;">6</td> <td>Not allowed</td> <td>DI1: First PFC Relay DI2: Second PFC Relay DI3: Third PFC Relay DI4: Fourth PFC Relay DI5: Fifth PFC Relay DI6: Sixth PFC Relay</td> </tr> </tbody> </table>	No. PFC relays	Autochange disabled (P 8118)	Autochange enabled (P 8118)	0	DI1: Speed Reg Motor DI2...DI6: Free	Not allowed	1	DI1: Speed Reg Motor DI2: First PFC Relay DI3...DI6: Free	DI1: First PFC Relay DI2...DI6: Free	2	DI1: Speed Reg Motor DI2: First PFC Relay DI3: Second PFC Relay DI4...DI6: Free	DI1: First PFC Relay DI2: Second PFC Relay DI3...DI6: Free	3	DI1: Speed Reg Motor DI2: First PFC Relay DI3: Second PFC Relay DI4: Third PFC Relay DI5...DI6: Free	DI1: First PFC Relay DI2: Second PFC Relay DI3: Third PFC Relay DI4...DI6: Free	4	DI1: Speed Reg Motor DI2: First PFC Relay DI3: Second PFC Relay DI4: Third PFC Relay DI5: Fourth PFC Relay DI6: Free	DI1: First PFC Relay DI2: Second PFC Relay DI3: Third PFC Relay DI4: Fourth PFC Relay DI5...DI6: Free	5	DI1: Speed Reg Motor DI2: First PFC Relay DI3: Second PFC Relay DI4: Third PFC Relay DI5: Fourth PFC Relay DI6: Fifth PFC Relay	DI1: First PFC Relay DI2: Second PFC Relay DI3: Third PFC Relay DI4: Fourth PFC Relay DI5: Fifth PFC Relay DI6: Free	6	Not allowed	DI1: First PFC Relay DI2: Second PFC Relay DI3: Third PFC Relay DI4: Fourth PFC Relay DI5: Fifth PFC Relay DI6: Sixth PFC Relay
No. PFC relays	Autochange disabled (P 8118)	Autochange enabled (P 8118)																							
0	DI1: Speed Reg Motor DI2...DI6: Free	Not allowed																							
1	DI1: Speed Reg Motor DI2: First PFC Relay DI3...DI6: Free	DI1: First PFC Relay DI2...DI6: Free																							
2	DI1: Speed Reg Motor DI2: First PFC Relay DI3: Second PFC Relay DI4...DI6: Free	DI1: First PFC Relay DI2: Second PFC Relay DI3...DI6: Free																							
3	DI1: Speed Reg Motor DI2: First PFC Relay DI3: Second PFC Relay DI4: Third PFC Relay DI5...DI6: Free	DI1: First PFC Relay DI2: Second PFC Relay DI3: Third PFC Relay DI4...DI6: Free																							
4	DI1: Speed Reg Motor DI2: First PFC Relay DI3: Second PFC Relay DI4: Third PFC Relay DI5: Fourth PFC Relay DI6: Free	DI1: First PFC Relay DI2: Second PFC Relay DI3: Third PFC Relay DI4: Fourth PFC Relay DI5...DI6: Free																							
5	DI1: Speed Reg Motor DI2: First PFC Relay DI3: Second PFC Relay DI4: Third PFC Relay DI5: Fourth PFC Relay DI6: Fifth PFC Relay	DI1: First PFC Relay DI2: Second PFC Relay DI3: Third PFC Relay DI4: Fourth PFC Relay DI5: Fifth PFC Relay DI6: Free																							
6	Not allowed	DI1: First PFC Relay DI2: Second PFC Relay DI3: Third PFC Relay DI4: Fourth PFC Relay DI5: Fifth PFC Relay DI6: Sixth PFC Relay																							

Code	Description																								
	<p>2 = DI2 – Enables the Interlock function and assigns a digital input (starting with DI2) to the interlock signal for each PFC relay. These assignments are defined in the following table and depend on:</p> <ul style="list-style-type: none"> <li>• the number of PFC relays [number of parameters 1401...1403 and 1410...1412 with value = 31 (PFC)]</li> <li>• the Autochange function status (disabled if 8118 AUTOCHNG INTERV = 0.0, and otherwise enabled).</li> </ul> <table border="1"> <thead> <tr> <th>No. PFC relays</th> <th>Autochange disabled (P 8118)</th> <th>Autochange enabled (P 8118)</th> </tr> </thead> <tbody> <tr> <td>0</td> <td>DI1: Free DI2: Speed Reg Motor DI3...DI6: Free</td> <td>Not allowed</td> </tr> <tr> <td>1</td> <td>DI1: Free DI2: Speed Reg Motor DI3: First PFC Relay DI4...DI6: Free</td> <td>DI1: Free DI2: First PFC Relay DI3...DI6: Free</td> </tr> <tr> <td>2</td> <td>DI1: Free DI2: Speed Reg Motor DI3: First PFC Relay DI4: Second PFC Relay DI5...DI6: Free</td> <td>DI1: Free DI2: First PFC Relay DI3: Second PFC Relay DI4...DI6: Free</td> </tr> <tr> <td>3</td> <td>DI1: Free DI2: Speed Reg Motor DI3: First PFC Relay DI4: Second PFC Relay DI5: Third PFC Relay DI6: Free</td> <td>DI1: Free DI2: First PFC Relay DI3: Second PFC Relay DI4: Third PFC Relay DI5...DI6: Free</td> </tr> <tr> <td>4</td> <td>DI1: Free DI2: Speed Reg Motor DI3: First PFC Relay DI4: Second PFC Relay DI5: Third PFC Relay DI6: Fourth PFC Relay</td> <td>DI1: Free DI2: First PFC Relay DI3: Second PFC Relay DI4: Third PFC Relay DI5: Fourth PFC Relay DI6: Free</td> </tr> <tr> <td>5</td> <td>Not allowed</td> <td>DI1: Free DI2: First PFC Relay DI3: Second PFC Relay DI4: Third PFC Relay DI5: Fourth PFC Relay DI6: Fifth PFC Relay</td> </tr> <tr> <td>6</td> <td>Not allowed</td> <td>Not allowed</td> </tr> </tbody> </table>	No. PFC relays	Autochange disabled (P 8118)	Autochange enabled (P 8118)	0	DI1: Free DI2: Speed Reg Motor DI3...DI6: Free	Not allowed	1	DI1: Free DI2: Speed Reg Motor DI3: First PFC Relay DI4...DI6: Free	DI1: Free DI2: First PFC Relay DI3...DI6: Free	2	DI1: Free DI2: Speed Reg Motor DI3: First PFC Relay DI4: Second PFC Relay DI5...DI6: Free	DI1: Free DI2: First PFC Relay DI3: Second PFC Relay DI4...DI6: Free	3	DI1: Free DI2: Speed Reg Motor DI3: First PFC Relay DI4: Second PFC Relay DI5: Third PFC Relay DI6: Free	DI1: Free DI2: First PFC Relay DI3: Second PFC Relay DI4: Third PFC Relay DI5...DI6: Free	4	DI1: Free DI2: Speed Reg Motor DI3: First PFC Relay DI4: Second PFC Relay DI5: Third PFC Relay DI6: Fourth PFC Relay	DI1: Free DI2: First PFC Relay DI3: Second PFC Relay DI4: Third PFC Relay DI5: Fourth PFC Relay DI6: Free	5	Not allowed	DI1: Free DI2: First PFC Relay DI3: Second PFC Relay DI4: Third PFC Relay DI5: Fourth PFC Relay DI6: Fifth PFC Relay	6	Not allowed	Not allowed
No. PFC relays	Autochange disabled (P 8118)	Autochange enabled (P 8118)																							
0	DI1: Free DI2: Speed Reg Motor DI3...DI6: Free	Not allowed																							
1	DI1: Free DI2: Speed Reg Motor DI3: First PFC Relay DI4...DI6: Free	DI1: Free DI2: First PFC Relay DI3...DI6: Free																							
2	DI1: Free DI2: Speed Reg Motor DI3: First PFC Relay DI4: Second PFC Relay DI5...DI6: Free	DI1: Free DI2: First PFC Relay DI3: Second PFC Relay DI4...DI6: Free																							
3	DI1: Free DI2: Speed Reg Motor DI3: First PFC Relay DI4: Second PFC Relay DI5: Third PFC Relay DI6: Free	DI1: Free DI2: First PFC Relay DI3: Second PFC Relay DI4: Third PFC Relay DI5...DI6: Free																							
4	DI1: Free DI2: Speed Reg Motor DI3: First PFC Relay DI4: Second PFC Relay DI5: Third PFC Relay DI6: Fourth PFC Relay	DI1: Free DI2: First PFC Relay DI3: Second PFC Relay DI4: Third PFC Relay DI5: Fourth PFC Relay DI6: Free																							
5	Not allowed	DI1: Free DI2: First PFC Relay DI3: Second PFC Relay DI4: Third PFC Relay DI5: Fourth PFC Relay DI6: Fifth PFC Relay																							
6	Not allowed	Not allowed																							

Code	Description																																							
	<p>3 = DI3 – Enables the Interlocks function and assigns a digital input (starting with DI3) to the interlock signal for each PFC relay. These assignments are defined in the following table and depend on:</p> <ul style="list-style-type: none"> <li>• the number of PFC relays [number of parameters 1401...1403 and 1410...1412 with value = 31 (PFC)]</li> <li>• the Autochange function status (disabled if 8118 AUTOCHNG INTERV = 0.0, and otherwise enabled).</li> </ul> <table border="1"> <thead> <tr> <th>No. PFC relays</th> <th>Autochange disabled (P 8118)</th> <th>Autochange enabled (P 8118)</th> </tr> </thead> <tbody> <tr> <td>0</td> <td>DI1...DI2: Free DI3: Speed Reg Motor DI4...DI6: Free</td> <td>Not allowed</td> </tr> <tr> <td>1</td> <td>DI1...DI2: Free DI3: Speed Reg Motor DI4: First PFC Relay DI5...DI6: Free</td> <td>DI1...DI2: Free DI3: First PFC Relay DI4...DI6: Free</td> </tr> <tr> <td>2</td> <td>DI1...DI2: Free DI3: Speed Reg Motor DI4: First PFC Relay DI5: Second PFC Relay DI6: Free</td> <td>DI1...DI2: Free DI3: First PFC Relay DI4: Second PFC Relay DI5...DI6: Free</td> </tr> <tr> <td>3</td> <td>DI1...DI2: Free DI3: Speed Reg Motor DI4: First PFC Relay DI5: Second PFC Relay DI6: Third PFC Relay</td> <td>DI1...DI2: Free DI3: First PFC Relay DI4: Second PFC Relay DI5: Third PFC Relay DI6: Free</td> </tr> <tr> <td>4</td> <td>Not allowed</td> <td>DI1...DI2: Free DI3: First PFC Relay DI4: Second PFC Relay DI5: Third PFC Relay DI6: Fourth PFC Relay</td> </tr> <tr> <td>5...6</td> <td>Not allowed</td> <td>Not allowed</td> </tr> </tbody> </table> <p>4 = DI4 – Enables the Interlock function and assigns a digital input (starting with DI4) to the interlock signal for each PFC relay. These assignments are defined in the following table and depend on:</p> <ul style="list-style-type: none"> <li>• the number of PFC relays [number of parameters 1401...1403 and 1410...1412 with value = 31 (PFC)]</li> <li>• the Autochange function status (disabled if 8118 AUTOCHNG INTERV = 0.0, and otherwise enabled).</li> </ul> <table border="1"> <thead> <tr> <th>No. PFC relays</th> <th>Autochange disabled (P 8118)</th> <th>Autochange enabled (P 8118)</th> </tr> </thead> <tbody> <tr> <td>0</td> <td>DI1...DI3: Free DI4: Speed Reg Motor DI5...DI6: Free</td> <td>Not allowed</td> </tr> <tr> <td>1</td> <td>DI1...DI3: Free DI4: Speed Reg Motor DI5: First PFC Relay DI6: Free</td> <td>DI1...DI3: Free DI4: First PFC Relay DI5...DI6: Free</td> </tr> <tr> <td>2</td> <td>DI1...DI3: Free DI4: Speed Reg Motor DI5: First PFC Relay DI6: Second PFC Relay</td> <td>DI1...DI3: Free DI4: First PFC Relay DI5: Second PFC Relay DI6: Free</td> </tr> <tr> <td>3</td> <td>Not allowed</td> <td>DI1...DI3: Free DI4: First PFC Relay DI5: Second PFC Relay DI6: Third PFC Relay</td> </tr> <tr> <td>4...6</td> <td>Not allowed</td> <td>Not allowed</td> </tr> </tbody> </table>	No. PFC relays	Autochange disabled (P 8118)	Autochange enabled (P 8118)	0	DI1...DI2: Free DI3: Speed Reg Motor DI4...DI6: Free	Not allowed	1	DI1...DI2: Free DI3: Speed Reg Motor DI4: First PFC Relay DI5...DI6: Free	DI1...DI2: Free DI3: First PFC Relay DI4...DI6: Free	2	DI1...DI2: Free DI3: Speed Reg Motor DI4: First PFC Relay DI5: Second PFC Relay DI6: Free	DI1...DI2: Free DI3: First PFC Relay DI4: Second PFC Relay DI5...DI6: Free	3	DI1...DI2: Free DI3: Speed Reg Motor DI4: First PFC Relay DI5: Second PFC Relay DI6: Third PFC Relay	DI1...DI2: Free DI3: First PFC Relay DI4: Second PFC Relay DI5: Third PFC Relay DI6: Free	4	Not allowed	DI1...DI2: Free DI3: First PFC Relay DI4: Second PFC Relay DI5: Third PFC Relay DI6: Fourth PFC Relay	5...6	Not allowed	Not allowed	No. PFC relays	Autochange disabled (P 8118)	Autochange enabled (P 8118)	0	DI1...DI3: Free DI4: Speed Reg Motor DI5...DI6: Free	Not allowed	1	DI1...DI3: Free DI4: Speed Reg Motor DI5: First PFC Relay DI6: Free	DI1...DI3: Free DI4: First PFC Relay DI5...DI6: Free	2	DI1...DI3: Free DI4: Speed Reg Motor DI5: First PFC Relay DI6: Second PFC Relay	DI1...DI3: Free DI4: First PFC Relay DI5: Second PFC Relay DI6: Free	3	Not allowed	DI1...DI3: Free DI4: First PFC Relay DI5: Second PFC Relay DI6: Third PFC Relay	4...6	Not allowed	Not allowed
No. PFC relays	Autochange disabled (P 8118)	Autochange enabled (P 8118)																																						
0	DI1...DI2: Free DI3: Speed Reg Motor DI4...DI6: Free	Not allowed																																						
1	DI1...DI2: Free DI3: Speed Reg Motor DI4: First PFC Relay DI5...DI6: Free	DI1...DI2: Free DI3: First PFC Relay DI4...DI6: Free																																						
2	DI1...DI2: Free DI3: Speed Reg Motor DI4: First PFC Relay DI5: Second PFC Relay DI6: Free	DI1...DI2: Free DI3: First PFC Relay DI4: Second PFC Relay DI5...DI6: Free																																						
3	DI1...DI2: Free DI3: Speed Reg Motor DI4: First PFC Relay DI5: Second PFC Relay DI6: Third PFC Relay	DI1...DI2: Free DI3: First PFC Relay DI4: Second PFC Relay DI5: Third PFC Relay DI6: Free																																						
4	Not allowed	DI1...DI2: Free DI3: First PFC Relay DI4: Second PFC Relay DI5: Third PFC Relay DI6: Fourth PFC Relay																																						
5...6	Not allowed	Not allowed																																						
No. PFC relays	Autochange disabled (P 8118)	Autochange enabled (P 8118)																																						
0	DI1...DI3: Free DI4: Speed Reg Motor DI5...DI6: Free	Not allowed																																						
1	DI1...DI3: Free DI4: Speed Reg Motor DI5: First PFC Relay DI6: Free	DI1...DI3: Free DI4: First PFC Relay DI5...DI6: Free																																						
2	DI1...DI3: Free DI4: Speed Reg Motor DI5: First PFC Relay DI6: Second PFC Relay	DI1...DI3: Free DI4: First PFC Relay DI5: Second PFC Relay DI6: Free																																						
3	Not allowed	DI1...DI3: Free DI4: First PFC Relay DI5: Second PFC Relay DI6: Third PFC Relay																																						
4...6	Not allowed	Not allowed																																						

Code	Description																											
	<p>5 = DI5 – Enables the Interlock function and assigns a digital input (starting with DI5) to the interlock signal for each PFC relay. These assignments are defined in the following table and depend on:</p> <ul style="list-style-type: none"> <li>• the number of PFC relays [number of parameters 1401...1403 and 1410...1412 with value = 31 (PFC)]</li> <li>• the Autochange function status (disabled if 8118 AUTOCHNG INTERV = 0.0, and otherwise enabled).</li> </ul> <table border="1"> <thead> <tr> <th>No. PFC relays</th> <th>Autochange disabled (P 8118)</th> <th>Autochange enabled (P 8118)</th> </tr> </thead> <tbody> <tr> <td>0</td> <td>DI1...DI4: Free DI5: Speed Reg Motor DI6: Free</td> <td>Not allowed</td> </tr> <tr> <td>1</td> <td>DI1...DI4: Free DI5: Speed Reg Motor DI6: First PFC Relay</td> <td>DI1...DI4: Free DI5: First PFC Relay DI6: Free</td> </tr> <tr> <td>2</td> <td>Not allowed</td> <td>DI1...DI4: Free DI5: First PFC Relay DI6: Second PFC Relay</td> </tr> <tr> <td>3...6</td> <td>Not allowed</td> <td>Not allowed</td> </tr> </tbody> </table> <p>6 = DI6 – Enables the Interlock function and assigns digital input DI6 to the interlock signal for the speed regulated motor.</p> <ul style="list-style-type: none"> <li>• Requires 8118 AUTOCHNG INTERV = 0.0.</li> </ul> <table border="1"> <thead> <tr> <th>No. PFC relays</th> <th>Autochange disabled</th> <th>Autochange enabled</th> </tr> </thead> <tbody> <tr> <td>0</td> <td>DI1...DI5: Free DI6: Speed Reg Motor</td> <td>Not allowed</td> </tr> <tr> <td>1</td> <td>Not allowed</td> <td>DI1...DI5: Free DI6: First PFC Relay</td> </tr> <tr> <td>2...6</td> <td>Not allowed</td> <td>Not allowed</td> </tr> </tbody> </table>	No. PFC relays	Autochange disabled (P 8118)	Autochange enabled (P 8118)	0	DI1...DI4: Free DI5: Speed Reg Motor DI6: Free	Not allowed	1	DI1...DI4: Free DI5: Speed Reg Motor DI6: First PFC Relay	DI1...DI4: Free DI5: First PFC Relay DI6: Free	2	Not allowed	DI1...DI4: Free DI5: First PFC Relay DI6: Second PFC Relay	3...6	Not allowed	Not allowed	No. PFC relays	Autochange disabled	Autochange enabled	0	DI1...DI5: Free DI6: Speed Reg Motor	Not allowed	1	Not allowed	DI1...DI5: Free DI6: First PFC Relay	2...6	Not allowed	Not allowed
No. PFC relays	Autochange disabled (P 8118)	Autochange enabled (P 8118)																										
0	DI1...DI4: Free DI5: Speed Reg Motor DI6: Free	Not allowed																										
1	DI1...DI4: Free DI5: Speed Reg Motor DI6: First PFC Relay	DI1...DI4: Free DI5: First PFC Relay DI6: Free																										
2	Not allowed	DI1...DI4: Free DI5: First PFC Relay DI6: Second PFC Relay																										
3...6	Not allowed	Not allowed																										
No. PFC relays	Autochange disabled	Autochange enabled																										
0	DI1...DI5: Free DI6: Speed Reg Motor	Not allowed																										
1	Not allowed	DI1...DI5: Free DI6: First PFC Relay																										
2...6	Not allowed	Not allowed																										

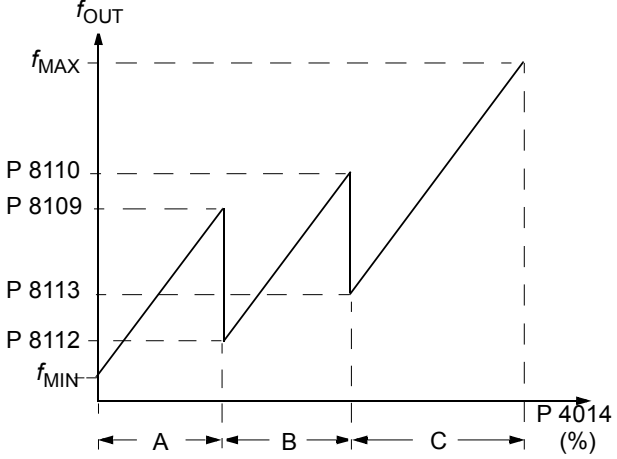
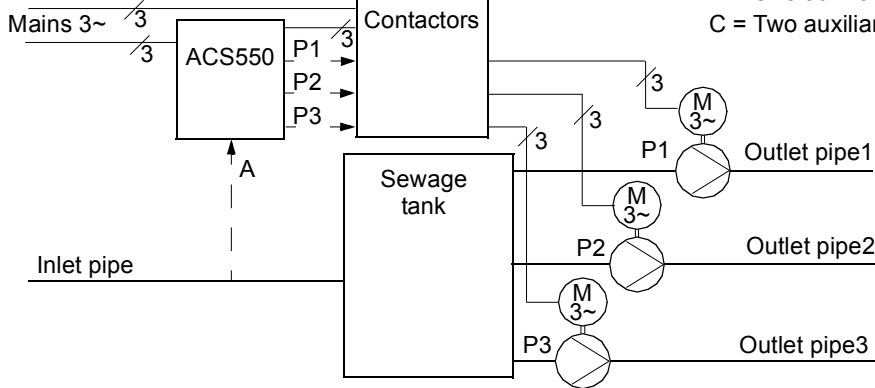
Code	Description
8121	<p><b>REG BYPASS CTRL</b></p> <p>Selects Regulator by-pass control. When enabled, Regulator by-pass control provides a simple control mechanism without a PID regulator.</p> <ul style="list-style-type: none"> <li>Use Regulator by-pass control only in special applications.</li> </ul> <p>0 = NO – Disables Regulator by-pass control. The drive uses the normal PFC reference: 1106 REF2 SELECT.</p> <p>1 = YES – Enables Regulator by-pass control.</p> <ul style="list-style-type: none"> <li>The process PID regulator is bypassed. Actual value of PID is used as the PFC reference (input). Normally EXT REF2 is used as the PFC reference.</li> <li>The drive uses the feedback signal defined by 4014 FBK SEL (or 4114) for the PFC frequency reference.</li> <li>The figure shows the relation between the control signal 4014 FBK SEL (OR 4114) and the speed regulated motor's frequency in a three-motor system.</li> </ul> <p><b>Example:</b> In the diagram below, the pumping station's outlet flow is controlled by the measured inlet flow (A).</p>  <p>A = No auxiliary motors running          B = One auxiliary motor running          C = Two auxiliary motors running</p> 
8122	<p><b>PFC START DELAY</b></p> <p>Sets the start delay for speed regulated motors in the system. Using the delay, the drive works as follows:</p> <ul style="list-style-type: none"> <li>Switches on the contactor of the speed regulated motor – connecting the motor to the ACS550 power output.</li> <li>Delays motor start for the time 8122 PFC START DELAY.</li> <li>Starts the speed regulated motor.</li> <li>Starts auxiliary motors. See parameter 8115 for delay.</li> </ul> <p><b>⚠ WARNING!</b> Motors equipped with star-delta starters require a PFC Start Delay.</p> <ul style="list-style-type: none"> <li>After the ACS550 relay output switches a motor on, the star-delta starter must switch to the star-connection and then back to the delta-connection before the drive applies power.</li> <li>So, the PFC Start Delay must be longer than the time setting of the star-delta starter.</li> </ul>
8123	<p><b>PFC ENABLE</b></p> <p>Selects PFC control. When enabled, PFC control:</p> <ul style="list-style-type: none"> <li>Switches in, or out, auxiliary constant speed motors as output demand increases or decreases. Parameters 8109 START FREQ 1 to 8114 LOW FREQ 3 define the switch points in terms of the drive output frequency.</li> <li>Adjusts the speed regulated motor output down, as auxiliary motors are added, and adjusts the speed regulated motor output up, as auxiliary motors are taken off line.</li> <li>Provides Interlock functions, if enabled.</li> <li>Requires 9904 MOTOR CTRL MODE = 3 (SCALAR:FREQ).</li> </ul> <p>0 = NOT SEL – Disables PFC control.</p> <p>1 = ACTIVE – Enables PFC control.</p>

Code	Description
8124	<p><b>ACC IN AUX STOP</b></p> <p>Sets the PFC acceleration time for a zero-to-maximum frequency ramp. This PFC acceleration ramp:</p> <ul style="list-style-type: none"> <li>• Applies to the speed regulated motor, when an auxiliary motor is switched off.</li> <li>• Replaces the acceleration ramp defined in <a href="#">Group 22: ACCEL/DECCEL</a>.</li> <li>• Applies only until the output of the regulated motor increases by an amount equal to the output of the switched off auxiliary motor. Then the acceleration ramp defined in <a href="#">Group 22: ACCEL/DECCEL</a> applies.</li> </ul> <p>0 = NOT SEL.            0.1...1800 – Activates this function using the value entered as the acceleration time.</p>
8125	<p><b>DEC IN AUX START</b></p> <p>Sets the PFC deceleration time for a maximum-to-zero frequency ramp. This PFC deceleration ramp:</p> <ul style="list-style-type: none"> <li>• Applies to the speed regulated motor, when an auxiliary motor is switched on.</li> <li>• Replaces the deceleration ramp defined in <a href="#">Group 22: ACCEL/DECCEL</a>.</li> <li>• Applies only until the output of the regulated motor decreases by an amount equal to the output of the auxiliary motor. Then the deceleration ramp defined in <a href="#">Group 22: ACCEL/DECCEL</a> applies.</li> </ul> <p>0 = NOT SEL.            0.1...1800 – Activates this function using the value entered as the deceleration time.</p>
8126	<p><b>TIMED AUTOCHNG</b></p> <p>Sets the autochange using a Timed function. See parameter 8119 AUTOCHNG LEVEL.</p> <p>0 = NOT SEL.            1 = TIMED FUNC 1 – Enables autochange when Timed function 1 is active.            2...4 = TIMED FUNC 2...4 – Enables autochange when Timed function 2...4 is active.</p>
8127	<p><b>MOTORS</b></p> <p>Sets the actual number of PFC controlled motors (maximum 7 motors, 1 speed regulated, 3 connected direct-on-line and 3 spare motors).</p> <ul style="list-style-type: none"> <li>• This value includes also the speed regulated motor.</li> <li>• This value must be compatible with the number of relays allocated to PFC if the Autochange function is used.</li> <li>• If Autochange function is not used, the speed regulated motor does not need to have a relay output allocated to PFC but it needs to be included in this value.</li> </ul>
8128	<p><b>AUX START ORDER</b></p> <p>Sets the start order of the auxiliary motors.</p> <p>1 = EVEN RUNTIME – Time sharing is active. Evens out the cumulative run time of the auxiliary motors. The start order depends on the run time: The auxiliary motor whose cumulative run time is shortest is started first, then the motor whose cumulative run time is the second shortest etc. When the demand drops, the first motor to be stopped is the one whose cumulative run time is longest.</p> <p>2 = RELAY ORDER – The start order is fixed to be the order of the relays.</p>

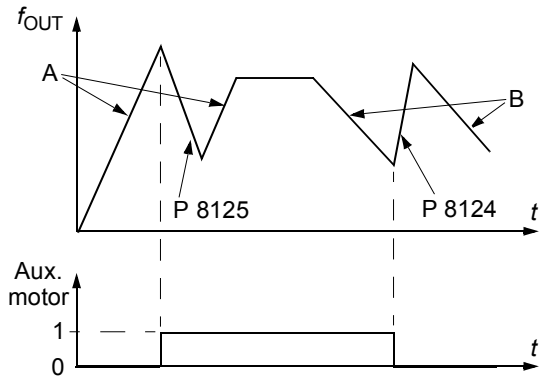

- A = speed regulated motor accelerating using [Group 22: ACCEL/DECCEL](#) parameters (2202 or 2205).
- B = speed regulated motor decelerating using [Group 22: ACCEL/DECCEL](#) parameters (2203 or 2206).
- At aux. motor start, speed regulated motor decelerates using 8125 DEC IN AUX START.
- At aux. motor stop, speed regulated motor accelerates using 8124 ACC IN AUX STOP.



**Group 98: OPTIONS**

This group configures for options, in particular, enabling serial communication with the drive.

Code	Description
9802	<b>COMM PROT SEL</b> Selects the communication protocol. 0 = NOT SEL – No communication protocol selected. 1 = STD MODBUS – The drive communicates with Modbus via the RS485 channel (X1-communications, terminal). <ul style="list-style-type: none"><li>• See also <a href="#">Group 53: EFB PROTOCOL</a>.</li></ul> 4 = EXT FBA – The drive communicates via a fieldbus adapter module in option slot 2 of the drive. <ul style="list-style-type: none"><li>• See also <a href="#">Group 51: EXT COMM MODULE</a>.</li></ul>



# Embedded fieldbus

---

## Overview

The ACS550 can be set up to accept control from an external system using standard serial communication protocols. When using serial communication, the ACS550 can either:

- receive all of its control information from the fieldbus, or
- be controlled from some combination of fieldbus control and other available control locations, such as digital or analog inputs and the control panel.

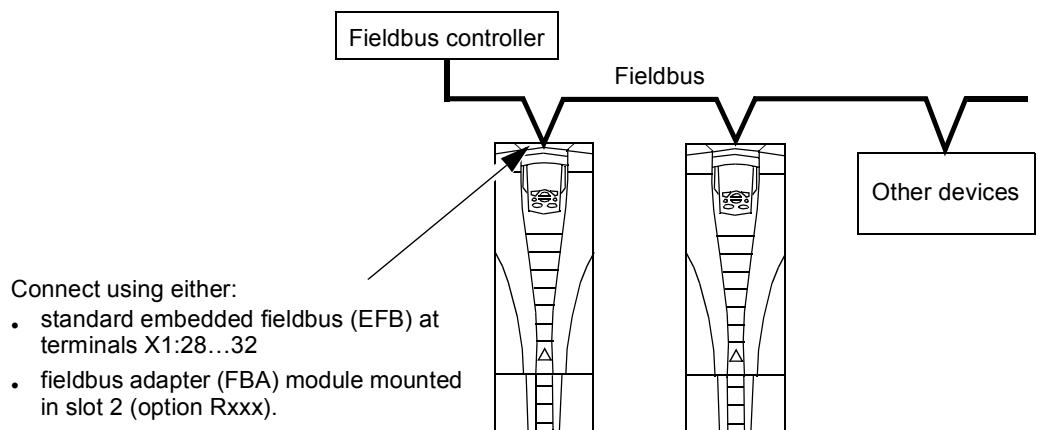

Two basic serial communications configurations are available:

- embedded fieldbus (EFB) – Using the RS485 interface at terminals X1:28...32 on the control board, a control system can communicate with the drive using the Modbus® protocol. (For protocol and profile descriptions, see sections [Modbus protocol technical data](#) and [ABB control profiles technical data](#) later in this chapter.)
- fieldbus adapter (FBA) – See chapter [Fieldbus adapter](#) on page 237.

## Control interface

In general, the basic control interface between Modbus and the drive consists of:

- Output words
  - Control Word
  - Reference1
  - Reference2
- Input words
  - Status Word
  - Actual value 1
  - Actual value 2

- Actual value 3
- Actual value 4
- Actual value 5
- Actual value 6
- Actual value 7
- Actual value 8

The content of these words is defined by profiles. For details on the profiles used, see section [ABB control profiles technical data](#) on page 224.

---

**Note:** The words “output” and “input” are used as seen from the fieldbus controller point of view. For example an output describes data flow from the fieldbus controller to the drive and appears as an input from the drive point of view.

---

## Planning

Network planning should address the following questions:

- What types and quantities of devices must be connected to the network?
- What control information must be sent down to the drives?
- What feedback information must be sent from the drives to the controlling system?

## Mechanical and electrical installation – EFB

---



**WARNING!** Connections should be made only while the drive is disconnected from the power source.

---

Drive terminals 28...32 are for RS485 communications.

- Use Belden 9842 or equivalent. Belden 9842 is a dual twisted, shielded pair cable with a wave impedance of 120 ohm.
- Use one of these twisted shielded pairs for the RS485 link. Use this pair to connect all A (-) terminals together and all B (+) terminals together.
- Use one of the wires in the other pair for the logical ground (terminal 31), leaving one wire unused.
- Do not directly ground the RS485 network at any point. Ground all devices on the network using their corresponding earthing terminals.
- As always, the grounding wires should not form any closed loops, and all the devices should be earthed to a common ground.
- Connect the RS485 link in a daisy-chained bus, without dropout lines.

- To reduce noise on the network, terminate the RS485 network using 120  $\Omega$  resistors at both ends of the network. Use the DIP switch to connect or disconnect the termination resistors. See the following diagram.

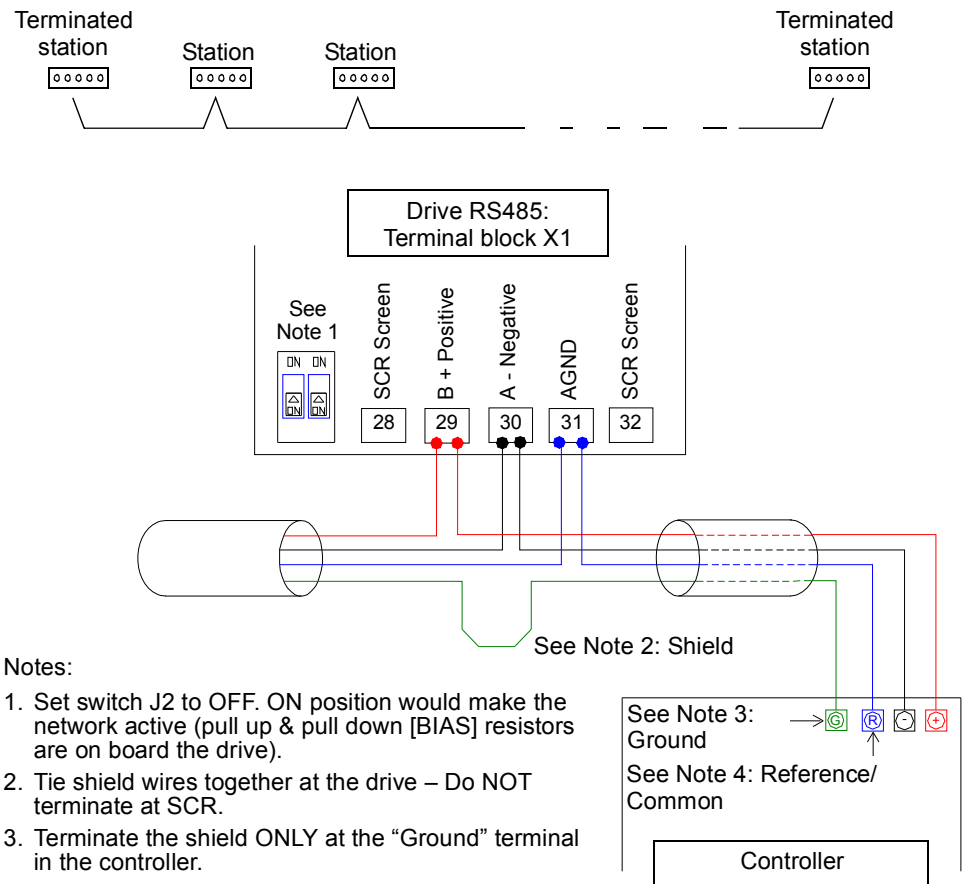

Notes:

- Set switch J2 to OFF. ON position would make the network active (pull up & pull down [BIAS] resistors are on board the drive).
  - Tie shield wires together at the drive – Do NOT terminate at SCR.
  - Terminate the shield ONLY at the “Ground” terminal in the controller.
  - Terminate the AGND wire at the “Reference” terminal in the controller.
- For configuration information see the following sections:
    - [Communication set-up – EFB](#) on page 205
    - [Activate drive control functions – EFB](#) on page 207
    - The appropriate EFB protocol specific technical data. For example, [Modbus protocol technical data](#) on page 215.

## Communication set-up – EFB

### Serial communication selection

To activate the serial communication, set parameter 9802 COMM PROT SEL = 1 (STD MODBUS).

**Note:** If you cannot see the desired selection on the panel, your drive does not have that protocol software in the application memory.

## Serial communication configuration

Setting 9802 automatically sets the appropriate default values in parameters that define the communication process. These parameters and descriptions are defined below. In particular, note that the station Id may require adjustment.

Code	Description	Protocol reference
		Modbus
5301	EFB PROTOCOL ID Contains the identification and program revision of the protocol.	Do not edit. Any non-zero value entered for parameter 9802 COMM PROT SEL, sets this parameter automatically. The format is: XXYY, where XX = protocol ID, and YY = program revision.
5302	EFB STATION ID Defines the node address of the RS485 link.  <b>Note:</b> For a new address to take affect, the drive power must be cycled or 5302 must first be set to 0 before selecting a new address. Leaving 5302 = 0 places the RS485 channel in reset, disabling communication.	Set each drive on the network with a unique value for this parameter. When this protocol is selected, the default value for this parameter is: 1
5303	EFB BAUD RATE Defines the communication speed of the RS485 link in kbits per second (kbits/s).  1.2 kb/s                      19.2 kb/s 2.4 kb/s                      38.4 kb/s 4.8 kb/s                      57.6 kb/s 9.6 kb/s                      76.8 kb/s	When this protocol is selected, the default value for this parameter is: 9.6
5304	EFB PARITY Defines the data length, parity and stop bits to be used with the RS485 communication.  • The same settings must be used in all on-line stations.  0 = 8 NONE 1 – 8 data bits, no parity, one stop bit. 1 = 8 NONE 2 – 8 data bits, no parity, two stop bits. 2 = 8 EVEN 1 – 8 data bits, even parity, one stop bit. 3 = 8 ODD 1 – 8 data bits, odd parity, one stop bit.	When this protocol is selected, the default value for this parameter is: 1
5305	EFB CTRL PROFILE Selects the communication profile used by the EFB protocol.  0 = ABB DRV LIM – Operation of Control/Status Words conforms to ABB Drives Profile, as used in ACS400. 1 = DCU PROFILE – Operation of Control/Status Words conforms to 32-bit DCU Profile. 2 = ABB DRV FULL – Operation of Control/Status Words conforms to ABB Drives Profile, as used in ACS600/800.	When this protocol is selected, the default value for this parameter is: 0

**Note:** After any changes to the communication settings, the protocol must be reactivated by either cycling the drive power, or by clearing and then restoring the station Id (5302).

## Activate drive control functions – EFB

### Controlling the drive

Fieldbus control of various drive functions requires configuration to:

- tell the drive to accept fieldbus control of the function
- define as a fieldbus input, any drive data required for control
- define as a fieldbus output, any control data required by the drive.

The following sections describe, at a general level, the configuration required for each control function. For the protocol-specific details, see the document supplied with the FBA module.

### Start/Stop Direction control

Using the fieldbus for start/stop/direction control of the drive requires:

- drive parameter values set as defined below
- fieldbus controller supplied command(s) in the appropriate location. (The location is defined by the Protocol Reference, which is protocol dependent.)

Drive parameter		Value	Description	Modbus <sup>1</sup> protocol reference	
				ABB DRV	DCU PROFILE
1001	EXT1 COMMANDS	10 (COMM)	Start/Stop by fieldbus with Ext1 selected.	40001 bits 0...3	40031 bits 0, 1
1002	EXT2 COMMANDS	10 (COMM)	Start/Stop by fieldbus with Ext2 selected.	40001 bits 0...3	40031 bits 0, 1
1003	DIRECTION	3 (REQUEST)	Direction by fieldbus.	4002/4003 <sup>2</sup>	40031 bit 3

<sup>1</sup> For Modbus, the protocol reference can depend on the profile used, hence two columns in these tables. One column refers to the ABB Drives profile, selected when parameter 5305 = 0 (ABB DRV LIM) or 5305 = 2 (ABB DRV FULL). The other column refers to the DCU profile selected when parameter 5305 = 1 (DCU PROFILE). See section [ABB control profiles technical data](#) on page 224.

<sup>2</sup> The reference provides direction control – a negative reference provides reverse rotation.

### Input reference select

Using the fieldbus to provide input references to the drive requires:

- drive parameter values set as defined below
- fieldbus controller supplied reference word(s) in the appropriate location. (The location is defined by the Protocol Reference, which is protocol dependent.)

Drive parameter		Value	Description	Modbus protocol reference	
				ABB DRV	DCU PROFILE
1102	EXT1/EXT2 SEL	8 (COMM)	Reference set selection by fieldbus.	40001 bit 11	40031 bit 5
1103	REF1 SELECT	8 (COMM)	Input reference 1 by fieldbus.	40002	
1106	REF2 SELECT	8 (COMM)	Input reference 2 by fieldbus.	40003	

### Reference Scaling

Where required, REFERENCES can be scaled. See the following, as appropriate:

- Modbus Register [40002](#) in section [Modbus protocol technical data](#) on page [215](#)
- [Reference scaling](#) in section [ABB control profiles technical data](#) on page [224](#).

### Miscellaneous drive control

Using the fieldbus for miscellaneous drive control requires:

- drive parameter values set as defined below
- fieldbus controller supplied command(s) in the appropriate location. (The location is defined by the Protocol Reference, which is protocol dependent.)

Drive parameter		Value	Description	Modbus protocol reference	
				ABB DRV	DCU PROFILE
1601	RUN ENABLE	7 (COMM)	Run enable by fieldbus.	40001 bit 3	40031 bit 6 (inverted)
1604	FAULT RESET SEL	8 (COMM)	Fault reset by fieldbus.	40001 bit 7	40031 bit 4
1606	LOCAL LOCK	8 (COMM)	Source for local lock selection is the fieldbus.	Does not apply	40031 bit 14
1607	PARAM SAVE	1 (SAVE)	Saves altered parameters to memory (then value returns to 0).	41607	
1608	START ENABLE 1	7 (COMM)	Source for start enable 1 is the fieldbus Command word.	Does not apply.	40032 bit 2
1609	START ENABLE 2	7 (COMM)	Source for start enable 2 is the fieldbus Command word.		40032 bit 3
2013	MIN TORQUE SEL	7 (COMM)	Source for minimum torque selection is the fieldbus.		40031 bit 15
2014	MAX TORQUE SEL	7 (COMM)	Source for maximum torque selection is the fieldbus.		
2201	ACC/DEC 1/2 SEL	7 (COMM)	Source for ramp pair selection is the fieldbus.		40031 bit 10



## Relay output control

Using the fieldbus for relay output control requires:

- drive parameter values set as defined below
- fieldbus controller supplied, binary coded, relay command(s) in the appropriate location. (The location is defined by the Protocol Reference, which is protocol dependent.)

Drive parameter		Value	Description	Modbus protocol reference	
				ABB DRV	DCU PROFILE
1401	RELAY OUTPUT 1	35 (COMM)	Relay Output 1 controlled by fieldbus.	40134 bit 0 or 00033	
1402	RELAY OUTPUT 2	35 (COMM)	Relay Output 2 controlled by fieldbus.	40134 bit 1 or 00034	
1403	RELAY OUTPUT 3	35 (COMM)	Relay Output 3 controlled by fieldbus.	40134 bit 2 or 00035	
1410 <sup>1</sup>	RELAY OUTPUT 4	35 (COMM)	Relay Output 4 controlled by fieldbus.	40134 bit 3 or 00036	
1411 <sup>1</sup>	RELAY OUTPUT 5	35 (COMM)	Relay Output 5 controlled by fieldbus.	40134 bit 4 or 00037	
1412 <sup>1</sup>	RELAY OUTPUT 6	35 (COMM)	Relay Output 6 controlled by fieldbus.	40134 bit 5 or 00038	

<sup>1</sup> More than 3 relays requires the addition of a relay extension module.

**Note:** Relay status feedback occurs without configuration as defined below.

Drive parameter		Description	Modbus protocol reference	
			ABB DRV	DCU PROFILE
0122	RO 1-3 STATUS	Relay 1...3 status.	40122	
0123	RO 4-6 STATUS	Relay 4...6 status.	40123	

## Analog output control

Using the fieldbus for analog output control (e.g. PID setpoint) requires:

- drive parameter values set as defined below
- fieldbus controller supplied analog value(s) in the appropriate location. (The location is defined by the Protocol Reference, which is protocol dependent.)

Drive parameter		Value	Description	Modbus protocol reference	
				ABB DRV	DCU PROFILE
1501	AO1 CONTENT SEL	135 (COMM VALUE 1)	Analog Output 1 controlled by writing to parameter 0135.	–	
0135	COMM VALUE 1	–		40135	
1507	AO2 CONTENT SEL	136 (COMM VALUE 2)	Analog Output 2 controlled by writing to parameter 0136.	–	
0136	COMM VALUE 2	–		40136	

### PID control setpoint source

Using the following settings to select the fieldbus as the setpoint source for PID loops:

Drive parameter		Value	Description	Modbus protocol reference	
				ABB DRV	DCU PROFILE
4010	SET POINT SEL (Set 1)	8 (COMM VALUE 1) 9 (COMM+A11) 10 (COMM*A11)	Setpoint is input reference 2 (+/-/* A11)	40003	
4110	SET POINT SEL (Set 2)				
4210	SET POINT SEL (Ext/Trim)				

### Communication fault

When using fieldbus control, specify the drive's action if serial communication is lost.

Drive parameter		Value	Description
3018	COMM FAULT FUNC	0 (NOT SEL) 1 (FAULT) 2 (CONST SP7) 3 (LAST SPEED)	Set for appropriate drive response.
3019	COMM FAULT TIME	Set time delay before acting on a communication loss.	

## Feedback from the drive – EFB

### Pre-defined feedback

Inputs to the controller (drive outputs) have pre-defined meanings established by the protocol. This feedback does not require drive configuration. The following table lists a sample of feedback data. For a complete listing, see input word/point/object listings in the technical data for the appropriate protocol starting on page [215](#).

Drive parameter		Modbus protocol reference	
		ABB DRV	DCU PROFILE
0102	SPEED	40102	
0103	OUTPUT FREQ	40103	
0104	CURRENT	40104	
0105	TORQUE	40105	
0106	POWER	40106	
0107	DC BUS VOLTAGE	40107	
0109	OUTPUT VOLTAGE	40109	
0301	FB CMD WORD1 – bit 0 (STOP)	40301 bit 0	
0301	FB CMD WORD1 1 – bit 2 (REV)	40301 bit 2	
0118	DI 1-3 STATUS – bit 0 (DI3)	40118	

**Note:** With Modbus, any parameter can be accessed using the format: “4” followed by the parameter number.

### Actual value scaling

The scaling of actual values can be protocol dependent. In general, for Actual Values, scale the feedback integer using the parameter's resolution. (See section [Complete parameter list](#) on page [91](#) for parameter resolutions.) For example:

Feedback integer	Parameter resolution	(Feedback integer) · (Parameter resolution) = Scaled value
1	0.1 mA	1 · 0.1 mA = 0.1 mA
10	0.1%	10 · 0.1% = 1%

Where parameters are in percent, the [Complete parameter descriptions](#) section specifies what parameter corresponds to 100%. In such cases, to convert from percent to engineering units, multiply by the value of the parameter that defines 100% and divide by 100%.

For example:

Feedback integer	Parameter resolution	Value of the parameter that defines 100%	(Feedback integer) · (Parameter resolution) · (Value of 100% ref.) / 100% = Scaled value
10	0.1%	1500 rpm <sup>1</sup>	$10 \cdot 0.1\% \cdot 1500 \text{ RPM} / 100\% = 15 \text{ rpm}$
100	0.1%	500 Hz <sup>2</sup>	$100 \cdot 0.1\% \cdot 500 \text{ Hz} / 100\% = 50 \text{ Hz}$

<sup>1</sup> Assuming, for the sake of this example, that the Actual Value uses parameter 9908 MOT NOM SPEED as the 100% reference and that 9908 = 1500 rpm.

<sup>2</sup> Assuming, for the sake of this example, that the Actual Value uses parameter 9907 MOT NOM FREQ as the 100% reference and that 9907 = 500 Hz.

## Diagnostics – EFB

### Fault queue for drive diagnostics

For general ACS550 diagnostics information, see chapter [Diagnostics](#) on page 259. The three most recent ACS550 faults are reported to the fieldbus as defined below.

Drive parameter		Modbus protocol reference	
		ABB DRV	DCU PROFILE
0401	LAST FAULT	40401	
0412	PREVIOUS FAULT 1	40412	
0413	PREVIOUS FAULT 2	40413	

### Serial communication diagnostics

Network problems can be caused by multiple sources. Some of these sources are:

- loose connections
- incorrect wiring (including swapped wires)
- bad grounding
- duplicate station numbers
- incorrect setup of drives or other devices on the network.

The major diagnostic features for fault tracing on an EFB network include [Group 53: EFB PROTOCOL](#) parameters 5306...5309. Section [Complete parameter descriptions](#) on page 106 describes these parameters in detail.

## Diagnostic situations

The sub-sections below describe various diagnostic situations – the problem symptoms and corrective actions.

### *Normal operation*

During normal network operation, 5306...5309 parameter values act as follows at each drive:

- 5306 EFB OK MESSAGES advances (advances for each message properly received and addressed to this drive).
- 5307 EFB CRC ERRORS does not advance at all (advances when an invalid message CRC is received).
- 5308 EFB UART ERRORS does not advance at all (advances when character format errors are detected, such as parity or framing errors).
- 5309 EFB STATUS value varies depending on network traffic.

### *Loss of communication*

The ACS550 behavior, if communication is lost, was configured earlier in section [Communication fault](#) on page 210. The parameters are 3018 COMM FAULT FUNC and 3019 COMM FAULT TIME. Section [Complete parameter descriptions](#) on page 106 describes these parameters in detail.

### *No master station on line*

If no master station is on line: Neither the EFB OK MESSAGES nor the errors (5307 EFB CRC ERRORS and 5308 EFB UART ERRORS) increase on any of the stations.

To correct:

- Check that a network master is connected and properly programmed on the network.
- Verify that the cable is connected and that it is not cut or short circuited.

### *Duplicate stations*

If two or more stations have duplicate numbers:

- Two or more drives cannot be addressed.
- Every time there is a read or write to one particular station, the value for 5307 EFB CRC ERRORS or 5308 EFB UART ERRORS advances.

To correct: Verify the station numbers of all stations. Change conflicting station numbers.

### *Swapped wires*

If the communication wires are swapped (terminal A on one drive is connected to terminal B on another):

- The value of 5306 EFB OK MESSAGES does not advance.
- The values of 5307 EFB CRC ERRORS and 5308 EFB UART ERRORS are advancing.

To correct: Check that the RS-485 lines are not swapped.

### *Fault 28 – Serial 1 Err*

If the drive's control panel shows fault code 28, SERIAL 1 ERR, check for either of the following:

- The master system is down. To correct, resolve problem with master system.
- The communication connection is bad. To correct, check communication connection at the drive.
- The time-out selection for the drive is too short for the given installation. The master is not polling the drive within the specified time-out delay. To correct, increase the time set by parameter 3019 COMM FAULT TIME.

### *Faults 31...33 – EFB1...EFB3*

The three EFB fault codes listed for the drive in chapter [Diagnostics](#) on page [259](#) (fault codes 31...33) are not used.

### *Intermittent off-line occurrences*

The problems described above are the most common problems encountered with ACS550 serial communication. Intermittent problems might also be caused by:

- marginally loose connections
- wear on wires caused by equipment vibrations
- insufficient grounding and shielding on both the devices and on the communication cables.

## Modbus protocol technical data

### Overview

The Modbus® protocol was introduced by Modicon, Inc. for use in control environments featuring Modicon programmable controllers. Due to its ease of use and implementation, this common PLC language was quickly adopted as a de-facto standard for integration of a wide variety of master controllers and slave devices.

Modbus is a serial, asynchronous protocol. Transactions are half-duplex, featuring a single Master controlling one or more Slaves. While RS232 can be used for point-to-point communication between a single Master and a single Slave, a more common implementation features a multi-drop RS485 network with a single Master controlling multiple Slaves. The ACS550 features RS485 for its Modbus physical interface.

### RTU

The Modbus specification defines two distinct transmission modes: ASCII and RTU. The ACS550 supports RTU only.

### Feature summary

The following Modbus function codes are supported by the ACS550.

Function	Code (Hex)	Description
Read Coil Status	0x01	Read discrete output status. For the ACS550, the individual bits of the control word are mapped to Coils 1...16. Relay outputs are mapped sequentially beginning with Coil 33 (e.g. RO1=Coil 33).
Read Discrete Input Status	0x02	Read discrete inputs status. For the ACS550, the individual bits of the status word are mapped to Inputs 1...16 or 1...32, depending on the active profile. Terminal inputs are mapped sequentially beginning with Input 33 (e.g. DI1=Input 33).
Read Multiple Holding Registers	0x03	Read multiple holding registers. For the ACS550, the entire parameter set is mapped as holding registers, as well as command, status and reference values.
Read Multiple Input Registers	0x04	Read multiple input registers. For the ACS550, the 2 analog input channels are mapped as input registers 1 & 2.
Force Single Coil	0x05	Write a single discrete output. For the ACS550, the individual bits of the control word are mapped to Coils 1...16. Relay outputs are mapped sequentially beginning with Coil 33 (e.g. RO1=Coil 33).
Write Single Holding Register	0x06	Write single holding register. For the ACS550, the entire parameter set is mapped as holding registers, as well as command, status and reference values.
Diagnostics	0x08	Perform Modbus diagnostics. Subcodes for Query (0x00), Restart (0x01) & Listen Only (0x04) are supported.
Force Multiple Coils	0x0F	Write multiple discrete outputs. For the ACS550, the individual bits of the control word are mapped to Coils 1...16. Relay outputs are mapped sequentially beginning with Coil 33 (e.g. RO1=Coil 33).
Write Multiple Holding Registers	0x10	Write multiple holding registers. For the ACS550, the entire parameter set is mapped as holding registers, as well as command, status and reference values.
Read/Write Multiple Holding Registers	0x17	This function combines functions 0x03 and 0x10 into a single command.

### Mapping summary

The following table summarizes the mapping between the ACS550 (parameters and I/O) and Modbus reference space. For details, see [Modbus addressing](#) below.

ACS550	Modbus reference	Supported function codes
<ul style="list-style-type: none"> <li>Control Bits</li> <li>Relay Outputs</li> </ul>	Coils(0xxxx)	<ul style="list-style-type: none"> <li>01 – Read Coil Status</li> <li>05 – Force Single Coil</li> <li>15 – Force Multiple Coils</li> </ul>
<ul style="list-style-type: none"> <li>Status Bits</li> <li>Discrete Inputs</li> </ul>	Discrete Inputs(1xxxx)	<ul style="list-style-type: none"> <li>02 – Read Input Status</li> </ul>
<ul style="list-style-type: none"> <li>Analog Inputs</li> </ul>	Input Registers(3xxxxx)	<ul style="list-style-type: none"> <li>04 – Read Input Registers</li> </ul>
<ul style="list-style-type: none"> <li>Parameters</li> <li>Control/Status Words</li> <li>References</li> </ul>	Holding Registers(4xxxx)	<ul style="list-style-type: none"> <li>03 – Read 4X Registers</li> <li>06 – Preset Single 4X Register</li> <li>16 – Preset Multiple 4X Registers</li> <li>23 – Read/Write 4X Registers</li> </ul>

### Communication profiles

When communicating by Modbus, the ACS550 supports multiple profiles for control and status information. Parameter 5305 EFB CTRL PROFILE selects the profile used.

- ABB DRV LIM – The primary (and default) profile is the ABB DRV LIM profile. This implementation of the ABB Drives profile standardizes the control interface with ACS400 drives. The ABB Drives profile is based on the PROFIBUS interface. It is discussed in detail in the following sections.
- DCU PROFILE – The DCU PROFILE profile extends the control and status interface to 32 bits. It is the internal interface between the main drive application and the embedded fieldbus environment.
- ABB DRV FULL – ABB DRV FULL is the implementation of the ABB Drives profile that standardizes the control interface with ACS600 and ACS800 drives. This implementation supports two control word bits not supported by the ABB DRV LIM implementation.

### Modbus addressing

With Modbus, each function code implies access to a specific Modbus reference set. Thus, the leading digit is not included in the address field of a Modbus message.

---

**Note:** The ACS550 supports the zero-based addressing of the Modbus specification. Holding register 40002 is addressed as 0001 in a Modbus message. Similarly, coil 33 is addressed as 0032 in a Modbus message.

---

Refer again to the [Mapping summary](#) above. The following sections describe, in detail, the mapping to each Modbus reference set.

**0xxxx Mapping – Modbus coils.** The drive maps the following information to the 0xxxx Modbus set called Modbus Coils:

- bit-wise map of the CONTROL WORD (selected using parameter 5305 EFB CTRL PROFILE). The first 32 coils are reserved for this purpose.



- relay output states, numbered sequentially beginning with coil 00033.

The following table summarizes the 0xxxx reference set:

Modbus ref.	Internal location (all profiles)	ABB DRV LIM (5305 = 0)	DCU PROFILE (5305 = 1)	ABB DRV FULL (5305 = 2)
00001	CONTROL WORD – Bit 0	OFF1 <sup>1</sup>	STOP	OFF1 <sup>1</sup>
00002	CONTROL WORD – Bit 1	OFF2 <sup>1</sup>	START	OFF2 <sup>1</sup>
00003	CONTROL WORD – Bit 2	OFF3 <sup>1</sup>	REVERSE	OFF3 <sup>1</sup>
00004	CONTROL WORD – Bit 3	START	LOCAL	START
00005	CONTROL WORD – Bit 4	N/A	RESET	RAMP_OUT_ZERO <sup>1</sup>
00006	CONTROL WORD – Bit 5	RAMP_HOLD <sup>1</sup>	EXT2	RAMP_HOLD <sup>1</sup>
00007	CONTROL WORD – Bit 6	RAMP_IN_ZERO <sup>1</sup>	RUN_DISABLE	RAMP_IN_ZERO <sup>1</sup>
00008	CONTROL WORD – Bit 7	RESET	STPMODE_R	RESET
00009	CONTROL WORD – Bit 8	N/A	STPMODE_EM	N/A
00010	CONTROL WORD – Bit 9	N/A	STPMODE_C	N/A
00011	CONTROL WORD – Bit 10	N/A	RAMP_2	REMOTE_CMD <sup>1</sup>
00012	CONTROL WORD – Bit 11	EXT2	RAMP_OUT_0	EXT2
00013	CONTROL WORD – Bit 12	N/A	RAMP_HOLD	N/A
00014	CONTROL WORD – Bit 13	N/A	RAMP_IN_0	N/A
00015	CONTROL WORD – Bit 14	N/A	REQ_LOCALLOCK	N/A
00016	CONTROL WORD – Bit 15	N/A	TORQLIM2	N/A
00017	CONTROL WORD – Bit 16	Does not apply	FBLOCAL_CTL	Does not apply
00018	CONTROL WORD – Bit 17		FBLOCAL_REF	
00019	CONTROL WORD – Bit 18		START_DISABLE1	
00020	CONTROL WORD – Bit 19		START_DISABLE2	
00021... 00032	Reserved	Reserved	Reserved	Reserved
00033	RELAY OUTPUT 1	Relay Output 1	Relay Output 1	Relay Output 1
00034	RELAY OUTPUT 2	Relay Output 2	Relay Output 2	Relay Output 2
00035	RELAY OUTPUT 3	Relay Output 3	Relay Output 3	Relay Output 3
00036	RELAY OUTPUT 4	Relay Output 4	Relay Output 4	Relay Output 4
00037	RELAY OUTPUT 5	Relay Output 5	Relay Output 5	Relay Output 5
00038	RELAY OUTPUT 6	Relay Output 6	Relay Output 6	Relay Output 6

<sup>1</sup> = Active low

For the 0xxxx registers:

- Status is always readable.
- Forcing is allowed by user configuration of the drive for fieldbus control.
- Additional relay outputs are added sequentially.

The ACS550 supports the following Modbus function codes for coils:

Function code	Description
01	Read coil status
05	Force single coil
15 (0x0F Hex)	Force multiple coils

**1xxxx Mapping – Modbus discrete inputs.** The drive maps the following information to the 1xxxx Modbus set called Modbus Discrete Inputs:

- bit-wise map of the STATUS WORD (selected using parameter 5305 EFB CTRL PROFILE). The first 32 inputs are reserved for this purpose.
- discrete hardware inputs, numbered sequentially beginning with input 33.

The following table summarizes the 1xxxx reference set:

Modbus ref.	Internal location (all profiles)	ABB DRV (5305 = 0 OR 2)	DCU PROFILE (5305 = 1)
10001	STATUS WORD – Bit 0	RDY_ON	READY
10002	STATUS WORD – Bit 1	RDY_RUN	ENABLED
10003	STATUS WORD – Bit 2	RDY_REF	STARTED
10004	STATUS WORD – Bit 3	TRIPPED	RUNNING
10005	STATUS WORD – Bit 4	OFF_2_STA <sup>1</sup>	ZERO_SPEED
10006	STATUS WORD – Bit 5	OFF_3_STA <sup>1</sup>	ACCELERATE
10007	STATUS WORD – Bit 6	SWC_ON_INHIB	DECELERATE
10008	STATUS WORD – Bit 7	ALARM	AT_SETPOINT
10009	STATUS WORD – Bit 8	AT_SETPOINT	LIMIT
10010	STATUS WORD – Bit 9	REMOTE	SUPERVISION
10011	STATUS WORD – Bit 10	ABOVE_LIMIT	REV_REF
10012	STATUS WORD – Bit 11	EXT2	REV_ACT
10013	STATUS WORD – Bit 12	RUN_ENABLE	PANEL_LOCAL
10014	STATUS WORD – Bit 13	N/A	FIELDBUS_LOCAL
10015	STATUS WORD – Bit 14	N/A	EXT2_ACT
10016	STATUS WORD – Bit 15	N/A	FAULT
10017	STATUS WORD – Bit 16	Reserved	ALARM
10018	STATUS WORD – Bit 17	Reserved	REQ_MAINT
10019	STATUS WORD – Bit 18	Reserved	DIRLOCK
10020	STATUS WORD – Bit 19	Reserved	LOCALLOCK
10021	STATUS WORD – Bit 20	Reserved	CTL_MODE
10022	STATUS WORD – Bit 21	Reserved	Reserved
10023	STATUS WORD – Bit 22	Reserved	Reserved
10024	STATUS WORD – Bit 23	Reserved	Reserved
10025	STATUS WORD – Bit 24	Reserved	Reserved
10026	STATUS WORD – Bit 25	Reserved	Reserved
10027	STATUS WORD – Bit 26	Reserved	REQ_CTL

Modbus ref.	Internal location (all profiles)	ABB DRV (5305 = 0 OR 2)	DCU PROFILE (5305 = 1)
10028	STATUS WORD – Bit 27	Reserved	REQ_REF1
10029	STATUS WORD – Bit 28	Reserved	REQ_REF2
10030	STATUS WORD – Bit 29	Reserved	REQ_REF2EXT
10031	STATUS WORD – Bit 30	Reserved	ACK_STARTINH
10032	STATUS WORD – Bit 31	Reserved	ACK_OFF_ILCK
10033	DI1	DI1	DI1
10034	DI2	DI2	DI2
10035	DI3	DI3	DI3
10036	DI4	DI4	DI4
10037	DI5	DI5	DI5
10038	DI6	DI6	DI6

<sup>1</sup> = Active low

For the 1xxxx registers:

- Additional discrete inputs are added sequentially.

The ACS550 supports the following Modbus function codes for discrete inputs:

Function code	Description
02	Read input status

**3xxxx Mapping – Modbus inputs.** The drive maps the following information to the 3xxxx Modbus addresses called Modbus input registers:

- any user defined analog inputs.

The following table summarizes the input registers:

Modbus reference	ACS550 all profiles	Remarks
30001	AI1	This register shall report the level of Analog Input 1 (0...100%).
30002	AI2	This register shall report the level of Analog Input 2 (0...100%).

The ACS550 supports the following Modbus function codes for 3xxxx registers:

Function code	Description
04	Read 3xxxx input status

**4xxxx Register mapping.** The drive maps its parameters and other data to the 4xxxx holding registers as follows:

- 40001...40099 map to drive control and actual values. These registers are described in the table below.
- 40101...49999 map to drive parameters 0101...9999. Register addresses that do not correspond to drive parameters are invalid. If there is an attempt to read or write outside the parameter addresses, the Modbus interface returns an exception code to the controller.

The following table summarizes the 4xxxx drive control registers 40001...40099 (for 4xxxx registers above 40099, see the drive parameter list, e.g. 40102 is parameter 0102):

Modbus register		Access	Remarks
40001	CONTROL WORD	R/W	Maps directly to the profile's CONTROL WORD. Supported only if 5305 = 0 or 2 (ABB Drives profile). Parameter 5319 holds a copy in hex format. If 5305 = 1 (DCU profile selected), the register remains empty.
40002	Reference 1	R/W	Range = 0...+20000 (scaled to 0...1105 REF1 MAX), or -20000...0 (scaled to 1105 REF1 MAX...0).
40003	Reference 2	R/W	Range = 0...+10000 (scaled to 0...1108 REF2 MAX), or -10000...0 (scaled to 1108 REF2 MAX...0).
40004	STATUS WORD	R	Maps directly to the profile's STATUS WORD. Supported only if 5305 = 0 or 2 (ABB Drives profile). Parameter 5320 holds a copy in hex format. If 5305 = 1 (DCU profile selected), the register remains empty.
40005	Actual 1 (select using 5310)	R	By default, stores a copy of 0103 OUTPUT FREQ. Use parameter 5310 to select a different actual value for this register.
40006	Actual 2 (select using 5311)	R	By default, stores a copy of 0104 CURRENT. Use parameter 5311 to select a different actual value for this register.
40007	Actual 3 (select using 5312)	R	By default, stores nothing. Use parameter 5312 to select an actual value for this register.
40008	Actual 4 (select using 5313)	R	By default, stores nothing. Use parameter 5313 to select an actual value for this register.
40009	Actual 5 (select using 5314)	R	By default, stores nothing. Use parameter 5314 to select an actual value for this register.
40010	Actual 6 (select using 5315)	R	By default, stores nothing. Use parameter 5315 to select an actual value for this register.
40011	Actual 7 (select using 5316)	R	By default, stores nothing. Use parameter 5316 to select an actual value for this register.
40012	Actual 8 (select using 5317)	R	By default, stores nothing. Use parameter 5317 to select an actual value for this register.
40031	ACS550 CONTROL WORD LSW	R/W	Maps directly to the Least Significant Word of the DCU profile's CONTROL WORD. Supported only if 5305 = 1. See parameter 0301.
40032	ACS550 CONTROL WORD MSW	R	Maps directly to the Most Significant Word of the DCU profile's CONTROL WORD. Supported only if 5305 = 1. See parameter 0302.
40033	ACS550 STATUS WORD LSW	R	Maps directly to the Least Significant Word of the DCU profile's STATUS WORD. Supported only if 5305 = 1. See parameter 0303.
40034	ACS550 STATUS WORD MSW	R	Maps directly to the Most Significant Word of the DCU profile's STATUS WORD. Supported only if 5305 = 1. See parameter 0304.
40045	REFERENCE 1 LSW	R/W	The least significant word of reference 1. Supported only by the DCU profile i.e. when 5305 ECB CTRL PROFILE setting is DCU profile.

<b>Modbus register</b>		<b>Access</b>	<b>Remarks</b>
40046	REFERENCE 1 MSW	R/W	The most significant word of reference 1. Supported only by the DCU profile i.e. when 5305 ECB CTRL PROFILE setting is DCU profile.
40047	REFERENCE 2 LSW	R/W	The least significant word of reference 2. Supported only by the DCU profile i.e. when 5305 ECB CTRL PROFILE setting is DCU profile.
40048	REFERENCE 2 MSW	R/W	The most significant word of reference 2. Supported only by DCU profile i.e. when 5305 ECB CTRL PROFILE setting is DCU profile.

For the Modbus protocol, drive parameters in [Group 53: EFB PROTOCOL](#) report the parameter mapping to 4xxxx Registers.

Code	Description
5310	EFB PAR 10 Specifies the parameter mapped to Modbus register 40005.
5311	EFB PAR 11 Specifies the parameter mapped to Modbus register 40006.
5312	EFB PAR 12 Specifies the parameter mapped to Modbus register 40007.
5313	EFB PAR 13 Specifies the parameter mapped to Modbus register 40008.
5314	EFB PAR 14 Specifies the parameter mapped to Modbus register 40009.
5315	EFB PAR 15 Specifies the parameter mapped to Modbus register 40010.
5316	EFB PAR 16 Specifies the parameter mapped to Modbus register 40011.
5317	EFB PAR 17 Specifies the parameter mapped to Modbus register 40012.
5318	EFB PAR 18 Sets additional delay in milliseconds before the ACS550 begins transmitting response to the master request.
5319	EFB PAR 19 Holds a copy (in hex) of the CONTROL WORD, Modbus register 40001.
5320	EFB PAR 20 Holds a copy (in hex) of the STATUS WORD, Modbus register 40004.

Except where restricted by the drive, all parameters are available for both reading and writing. The parameter writes are verified for the correct value and for a valid register addresses.

---

**Note:** Parameter writes through standard Modbus are always volatile i.e. modified values are not automatically stored to permanent memory. Use parameter 1607 PARAM SAVE to save all altered values.

---

The ACS550 supports the following Modbus function codes for 4xxxx registers:

Function code	Description
03	Read holding 4xxxx registers
06	Preset single 4xxxx register
16 (0x10 Hex)	Preset multiple 4xxxx registers
23 (0x17 Hex)	Read/write 4xxxx registers

### Actual values

The contents of the register addresses 40005...40012 are ACTUAL VALUES and are:

- specified using parameters 5310...5317
- Read-only values containing information on the operation of the drive
- 16-bit words containing a sign bit and a 15-bit integer
- when negative values, written as the two's complement of the corresponding positive value
- scaled as described earlier in section [Actual value scaling](#) on page 211.

### Exception codes

Exception codes are serial communication responses from the drive. The ACS550 supports the standard Modbus exception codes defined below.

Exception code	Name	Meaning
01	ILLEGAL FUNCTION	Unsupported Command
02	ILLEGAL DATA ADDRESS	The data address received in the query is not allowable. It is not a defined parameter/group.
03	ILLEGAL DATA VALUE	A value contained in the query data field is not an allowable value for the ACS550, because it is one of the following: <ul style="list-style-type: none"> <li>• Outside min. or max. limits.</li> <li>• Parameter is read-only.</li> <li>• Message is too long.</li> <li>• Parameter write not allowed when start is active.</li> <li>• Parameter write not allowed when factory macro is selected.</li> </ul>

## ABB control profiles technical data

### Overview

#### *ABB Drives profile*

The ABB Drives profile provides a standard profile that can be used on multiple protocols, including Modbus and the protocols available on the FBA module. Two implementations of the ABB Drives profile are available:

- ABB DRV FULL – This implementation standardizes the control interface with ACS600 and ACS800 drives.
- ABB DRV LIM – This implementation standardizes the control interface with ACS400 drives. This implementation does not support two control word bits supported by ABB DRV FULL.

Except as noted, the following “ABB Drives Profile” descriptions apply to both implementations.

#### *DCU profile*

The DCU profile extends the control and status interface to 32 bits. It is the internal interface between the main drive application and the embedded fieldbus environment.

### Control Word

The CONTROL WORD is the principal means for controlling the drive from a fieldbus system. The fieldbus master station sends the CONTROL WORD to the drive. The drive switches between states according to the bit-coded instructions in the CONTROL WORD. Using the CONTROL WORD requires that:

- The drive is in remote (REM) control.
- The serial communication channel is defined as the source for controlling commands (set using parameters such as 1001 EXT1 COMMANDS, 1002 EXT2 COMMANDS and 1102 EXT1/EXT2 SEL).
- The serial communication channel used is configured to use an ABB control profile. For example, to use the control profile ABB DRV FULL requires both parameter 9802 COMM PROT SEL = 1 (STD MODBUS) and parameter 5305 EFB CTRL PROFILE = 2 (ABB DRV FULL).



### ABB Drives profile

The following table and the state diagram later in this sub-section describe the CONTROL WORD content for the ABB Drives profile.

ABB Drives profile CONTROL WORD (See parameter 5319)				
Bit	Name	Value	Commanded state	Comments
0	OFF1 CONTROL	1	READY TO OPERATE	Enter READY TO OPERATE
		0	EMERGENCY OFF	Drive ramps to stop according to currently active deceleration ramp (2203 or 2205) Normal command sequence: <ul style="list-style-type: none"> <li>• Enter OFF1 ACTIVE</li> <li>• Proceed to READY TO SWITCH ON, unless other interlocks (OFF2, OFF3) are active.</li> </ul>
1	OFF2 CONTROL	1	OPERATING	Continue operation (OFF2 inactive)
		0	EMERGENCY OFF	Drive coasts to stop. Normal command sequence: <ul style="list-style-type: none"> <li>• Enter OFF2 ACTIVE</li> <li>• Proceed to SWITCHON INHIBITED</li> </ul>
2	OFF3 CONTROL	1	OPERATING	Continue operation (OFF3 inactive)
		0	EMERGENCY STOP	Drive stops within time specified by parameter 2208. Normal command sequence: <ul style="list-style-type: none"> <li>• Enter OFF3 ACTIVE</li> <li>• Proceed to SWITCH ON INHIBITED</li> </ul>  <b>WARNING!</b> Be sure motor and driven equipment can be stopped using this mode.
3	INHIBIT OPERATION	1	OPERATION ENABLED	Enter OPERATION ENABLED (Note the Run enable signal must be active. See 1601. If 1601 is set to COMM, this bit also activates the Run Enable signal.)
		0	OPERATION INHIBITED	Inhibit operation. Enter OPERATION INHIBITED
4	Unused (ABB DRV LIM)			
	RAMP_OUT_ZERO (ABB DRV FULL)	1	NORMAL OPERATION	Enter RAMP FUNCTION GENERATOR: ACCELERATION ENABLED
		0	RFG OUT ZERO	Force ramp function generator output to Zero. Drive ramps to stop (current and DC voltage limits in force).
5	RAMP_HOLD	1	RFG OUT ENABLED	Enable ramp function. Enter RAMP FUNCTION GENERATOR: ACCELERATOR ENABLED
		0	RFG OUT HOLD	Halt ramping (Ramp Function Generator output held)
6	RAMP_IN_ZERO	1	RFG INPUT ENABLED	Normal operation. Enter OPERATING
		0	RFG INPUT ZERO	Force Ramp Function Generator input to zero.

ABB Drives profile CONTROL WORD (See parameter 5319)				
Bit	Name	Value	Commanded state	Comments
7	RESET	0=>1	RESET	Fault reset if an active fault exists (Enter SWITCH-ON INHIBITED). Effective if 1604 = COMM.
		0	OPERATING	Continue normal operation
8...9	Unused			
10	Unused (ABB DRV LIM)			
	REMOTE_CMD (ABB DRV FULL)	1		Fieldbus control enabled.
		0		<ul style="list-style-type: none"> <li>CW ≠ 0 or Ref ≠ 0: Retain last CW and Ref.</li> <li>CW = 0 and Ref = 0: Fieldbus control enabled.</li> <li>Ref and deceleration/acceleration ramp are locked.</li> </ul>
11	EXT CTRL LOC	1	EXT2 SELECT	Select external control location 2 (EXT2). Effective if 1102 = COMM.
		0	EXT1 SELECT	Select external control location 1 (EXT1). Effective if 1102 = COMM.
12...15	Unused			

### DCU Profile

The following tables describe the CONTROL WORD content for the DCU profile.

DCU profile CONTROL WORD (See parameter 0301)				
Bit	Name	Value	Command/Req.	Comments
0	STOP	1	Stop	Stops according to either the stop mode parameter or the stop mode requests (bits 7 and 8).
		0	(no op)	
1	START	1	Start	Simultaneous STOP and START commands result in a stop command.
		0	(no op)	
2	REVERSE	1	Reverse direction	This bit XOR'd with the sign of the reference defines direction.
		0	Forward direction	
3	LOCAL	1	Local mode	When the fieldbus sets this bit, it steals control and the drive moves to fieldbus local control mode.
		0	External mode	
4	RESET	-> 1	Reset	Edge sensitive.
		other	(no op)	
5	EXT2	1	Switch to EXT2	
		0	Switch to EXT1	
6	RUN_DISABLE	1	Run disable	Inverted run enable.
		0	Run enable on	
7	STPMODE_R	1	Normal ramp stop mode	
		0	(no op)	

DCU profile CONTROL WORD (See parameter 0301)				
Bit	Name	Value	Command/Req.	Comments
8	STPMODE_EM	1	Emergency ramp stop mode	
		0	(no op)	
9	STPMODE_C	1	Coast stop mode	
		0	(no op)	
10	RAMP_2	1	Ramp pair 2	
		0	Ramp pair 1	
11	RAMP_OUT_0	1	Ramp output to 0	
		0	(no op)	
12	RAMP_HOLD	1	Ramp freeze	
		0	(no op)	
13	RAMP_IN_0	1	Ramp input to 0	
		0	(no op)	
14	RREQ_LOCALL OC	1	Local mode lock	In lock, drive will not switch to local mode.
		0	(no op)	
15	TORQLIM2	1	Torque limit pair 2	
		0	Torque limit pair 1	

DCU profile CONTROL WORD (See parameter 0302)				
Bit	Name	Value	Function	Comments
16...26	Reserved			
27	REF_CONST	1	Constant speed ref.	These bits are only for supervision purposes.
		0	(no op)	
28	REF_AVE	1	Average speed ref.	
		0	(no op)	
29	LINK_ON	1	Master is detected in link	
		0	Link is down	
30	REQ_STARTINH	1	Start inhibit request is pending	
		0	Start inhibit request is OFF	
31	OFF_INTERLOCK	1	Panel OFF button pressed	For the control panel (or PC tool) this is the OFF button interlock.
		0	(no op)	

### Status Word

The contents of the STATUS WORD is status information, sent by the drive to the master station.

### ABB Drives profile

The following table and the state diagram later in this sub-section describe the STATUS WORD content for the ABB Drives profile.

ABB Drives profile (EFB) STATUS WORD (See parameter 5320)			
Bit	Name	Value	Description (Correspond to states/boxes in the state diagram)
0	RDY_ON	1	READY TO SWITCH ON
		0	NOT READY TO SWITCH ON
1	RDY_RUN	1	READY TO OPERATE
		0	OFF1 ACTIVE
2	RDY_REF	1	OPERATION ENABLED
		0	OPERATION INHIBITED
3	TRIPPED	0...1	FAULT
		0	No fault
4	OFF_2_STA	1	OFF2 INACTIVE
		0	OFF2 ACTIVE
5	OFF_3_STA	1	OFF3 INACTIVE
		0	OFF3 ACTIVE
6	SWC_ON_INHIB	1	SWITCH-ON INHIBIT ACTIVE
		0	SWITCH-ON INHIBIT NOT ACTIVE
7	ALARM	1	Alarm (See section <a href="#">Alarm listing</a> on page 267 for details on alarms.)
		0	No alarm
8	AT_SETPOINT	1	OPERATING. Actual value equals (within tolerance limits) the reference value.
		0	Actual value is outside tolerance limits (not equal to reference value).
9	REMOTE	1	Drive control location: REMOTE (EXT1 or EXT2)
		0	Drive control location: LOCAL
10	ABOVE_LIMIT	1	Supervised parameter's value $\geq$ supervision high limit. Bit remains "1" until supervised parameter's value < supervision low limit. See <a href="#">Group 32: SUPERVISION</a> .
		0	Supervised parameter's value < supervision low limit. Bit remains "0" until supervised parameter's value > supervision high limit. See <a href="#">Group 32: SUPERVISION</a> .
11	EXT CTRL LOC	1	External control location 2 (EXT2) selected
		0	External control location 1 (EXT1) selected
12	EXT RUN ENABLE	1	External Run Enable signal received
		0	No External Run Enable signal received
13... 15	Unused		

*DCU profile*

The following tables describe the STATUS WORD content for the DCU profile.

DCU profile STATUS WORD (See parameter 0303)			
Bit	Name	Value	Status
0	READY	1	Drive is ready to receive start command.
		0	Drive is not ready.
1	ENABLED	1	External run enable signal received.
		0	No external run enable signal received.
2	STARTED	1	Drive has received start command.
		0	Drive has not received start command.
3	RUNNING	1	Drive is modulating.
		0	Drive is not modulating.
4	ZERO_SPEED	1	Drive is at zero speed.
		0	Drive has not reached zero speed.
5	ACCELERATE	1	Drive is accelerating.
		0	Drive is not accelerating.
6	DECELERATE	1	Drive is decelerating.
		0	Drive is not decelerating.
7	AT_SETPOINT	1	Drive is at setpoint.
		0	Drive has not reached setpoint.
8	LIMIT	1	Operation is limited by <i>Group 20: LIMITS</i> settings.
		0	Operation is within <i>Group 20: LIMITS</i> settings.
9	SUPERVISION	1	A supervised parameter ( <i>Group 32: SUPERVISION</i> ) is outside its limits.
		0	All supervised parameters are within limits.
10	REV_REF	1	Drive reference is in reverse direction.
		0	Drive reference is in forward direction.
11	REV_ACT	1	Drive is running in reverse direction.
		0	Drive is running in forward direction.
12	PANEL_LOCAL	1	Control is in control panel (or PC tool) local mode.
		0	Control is not in control panel local mode.
13	FIELDBUS_LOCAL	1	Control is in fieldbus local mode (steals control panel local).
		0	Control is not in fieldbus local mode.
14	EXT2_ACT	1	Control is in EXT2 mode.
		0	Control is in EXT1 mode.
15	FAULT	1	Drive is in a fault state.
		0	Drive is not in a fault state.

DCU profile STATUS WORD (See parameter 0304)			
Bit	Name	Value	Status
16	ALARM	1	An alarm is on.
		0	No alarms are on.
17	REQ_MAINT	1	A maintenance request is pending.
		0	No maintenance request is pending.
18	DIRLOCK	1	Direction lock is ON. (Direction change is locked out.)
		0	Direction lock is OFF.
19	LOCALLOCK	1	Local mode lock is ON. (Local mode is locked out.)
		0	Local mode lock is OFF.
20	CTL_MODE	1	Drive is in vector control mode.
		0	Drive is in scalar control mode.
21...25	Reserved		
26	REQ_CTL	1	Copy the control word
		0	(no op)
27	REQ_REF1	1	Reference 1 requested in this channel.
		0	Reference 1 is not requested in this channel.
28	REQ_REF2	1	Reference 2 requested in this channel.
		0	Reference 2 is not requested in this channel.
29	REQ_REF2EXT	1	External PID reference 2 requested in this channel.
		0	External PID reference 2 is not requested in this channel.
30	ACK_STARTINH	1	A start inhibit from this channel is granted.
		0	A start inhibit from this channel is not granted.
31	ACK_OFF_ILCK	1	Start inhibit due to OFF button
		0	Normal operation

## State diagram

### ABB Drives profile

To illustrate the operation of the state diagram, the following example (ABB DRV LIM implementation of the ABB Drives profile) uses the control word to start the drive:

- First, the requirements for using the CONTROL WORD must be met. See above.
- When the power is first connected, the state of the drive is not ready to switch on. See dotted lined path ( --- ) in the state diagram below.
- Use the CONTROL WORD to step through the state machine states until the OPERATING state is reached, meaning that the drive is running and follows the given reference. See the table below.

Step	CONTROL WORD Value	Description
1	CW = 0000 0000 0000 0110                              bit 15                  bit 0	This CW value changes the drive state to READY TO SWITCH ON.
2		Wait at least 100 ms before proceeding.
3	CW = 0000 0000 0000 0111	This CW value changes the drive state to READY TO OPERATE.
4	CW = 0000 0000 0000 1111	This CW value changes the drive state to OPERATION ENABLED. The drive starts, but will not accelerate.
5	CW = 0000 0000 0010 1111	This CW value releases the ramp function generator (RFG) output and changes the drive state to RFG: ACCELERATOR ENABLED.
6	CW = 0000 0000 0110 1111	This CW value releases the ramp function generator (RFG) output and changes the drive state to OPERATING. The drive accelerates to the given reference and follows the reference.

The state diagram below describes the start-stop function of CONTROL WORD (CW) and STATUS WORD (SW) bits for the ABB Drives profile.

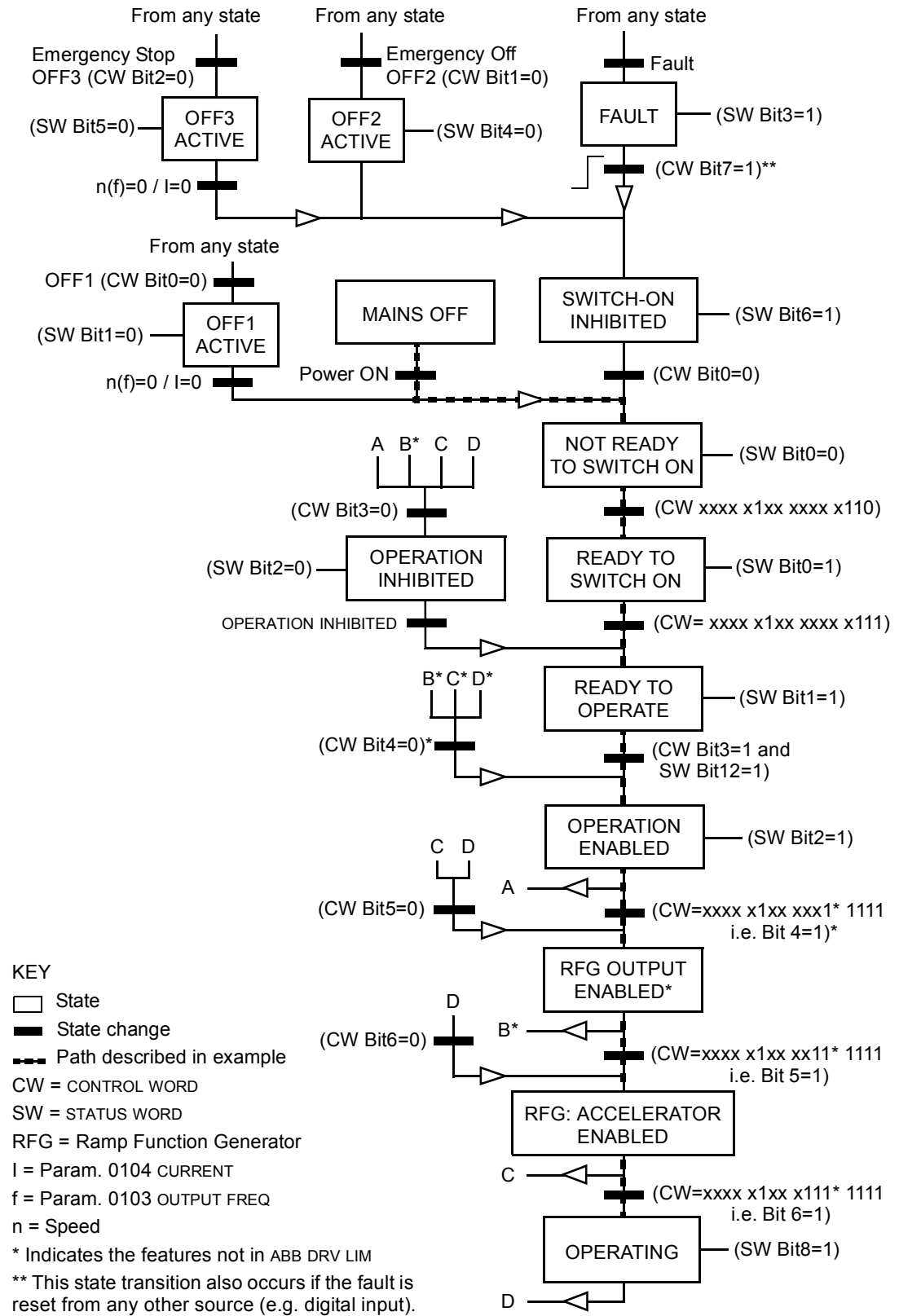



## Reference scaling

Fieldbus references REF1 and REF2 are scaled as shown in the following tables.

### Fieldbus scaling for ABB Drives profile

Reference	Range	Reference type	Scaling	Remarks
REF1	-32767 ... +32767	Speed or frequency	-20000 = <b>-(par. 1105)</b> 0 = 0 +20000 = <b>(par. 1105)</b> (20000 corresponds to 100%)	Final reference limited by 1104/1105. Actual motor speed limited by 2001/2002 (speed) or 2007/2008 (frequency).
REF2	-32767 ... +32767	Speed or frequency	-10000 = <b>-(par. 1108)</b> 0 = 0 +10000 = <b>(par. 1108)</b> (10000 corresponds to 100%)	Final reference limited by 1107/1108. Actual motor speed limited by 2001/2002 (speed) or 2007/2008 (frequency).
		Torque	-10000 = <b>-(par. 1108)</b> 0 = 0 +10000 = <b>(par. 1108)</b> (10000 corresponds to 100%)	Final reference limited by 2015/2017 (torque1) or 2016/2018 (torque2).
		PID Reference	-10000 = <b>-(par. 1108)</b> 0 = 0 +10000 = <b>(par. 1108)</b> (10000 corresponds to 100%)	Final reference limited by 4012/4013 (PID set1) or 4112/4113 (PID set2).

**Note:** The setting of parameter 1104 REF1 MIN and 1107 REF2 MIN has no effect on the scaling of references.

### Fieldbus scaling for DCU profile

Reference	Range	Reference type	Scaling	Remarks
REF1	-214783648 ... +214783647	Speed or frequency	1000 = 1 rpm / 1 Hz	Final reference limited by 1104/1105. Actual motor speed limited by 2001/2002 (speed) or 2007/2008 (frequency).
REF2	-214783648 ... +214783647	Speed or frequency	1000 = 1%	Final reference limited by 1107/1108. Actual motor speed limited by 2001/2002 (speed) or 2007/2008 (frequency).
		Torque	1000 = 1%	Final reference limited by 2015/2017 (torque1) or 2016/2018 (torque2).
		PID Reference	1000 = 1%	Final reference limited by 4012/4013 (PID set1) or 4112/4113 (PID set2).

**Note:** The setting of parameter 1104 REF1 MIN and 1107 REF2 MIN has no effect on the scaling of references.

Scaling examples

When parameter 1103 REF1 SELECT or 1106 REF2 SELECT is set to COMM+AI1 or COMM\*AI1, the reference is scaled as follows:

ABB Drives and DCU profiles		
Reference	Value setting	AI reference scaling
REF1	COMM+AI1	$\text{COMM (\%)} + (\text{AI (\%)} - 0.5 \cdot \text{REF1 MAX (\%)})$
REF1	COMM*AI1	$\text{COMM (\%)} \cdot (\text{AI (\%)} / 0.5 \cdot \text{REF1 MAX (\%)})$
REF2	COMM+AI1	$\text{COMM (\%)} + (\text{AI (\%)} - 0.5 \cdot \text{REF2 MAX (\%)})$

ABB Drives and DCU profiles		
Reference	Value setting	AI reference scaling
REF2	COMM*AI1	$\text{COMM (\%)} \cdot (\text{AI (\%)} / 0.5 \cdot \text{REF2 MAX (\%)})$

Reference handling

Use *Group 10: START/STOP/DIR* parameters to configure for control of rotation direction for each control location (EXT1 and EXT2). The following diagrams illustrate how group 10 parameters and the sign of the fieldbus reference interact to produce REFERENCE values (REF1 and REF2). Note, fieldbus references are bipolar, that is they can be positive or negative.

ABB Drives profile		
Parameter	Value setting	AI reference scaling
1003 DIRECTION	1 (FORWARD)	<p>Max. ref</p> <p>Fieldbus reference</p> <p>-163% -100%</p> <p>100% 163%</p> <p>Resultant ref.</p> <p>-(Max. ref.)</p>
1003 DIRECTION	2 (REVERSE)	<p>Max. ref</p> <p>Fieldbus reference</p> <p>-163% -100%</p> <p>100% 163%</p> <p>Resultant ref.</p> <p>-(Max. ref.)</p>
1003 DIRECTION	3 (REQUEST)	<p>Max. ref</p> <p>Fieldbus reference</p> <p>-163% -100%</p> <p>100% 163%</p> <p>Resultant ref.</p> <p>-(Max. ref.)</p>

# Fieldbus adapter

---

## Overview

The ACS550 can be set up to accept control from an external system using standard serial communication protocols. When using serial communication, the ACS550 can either:

- receive all of its control information from the fieldbus, or
- be controlled from some combination of fieldbus control and other available control locations, such as digital or analog inputs and the control panel.

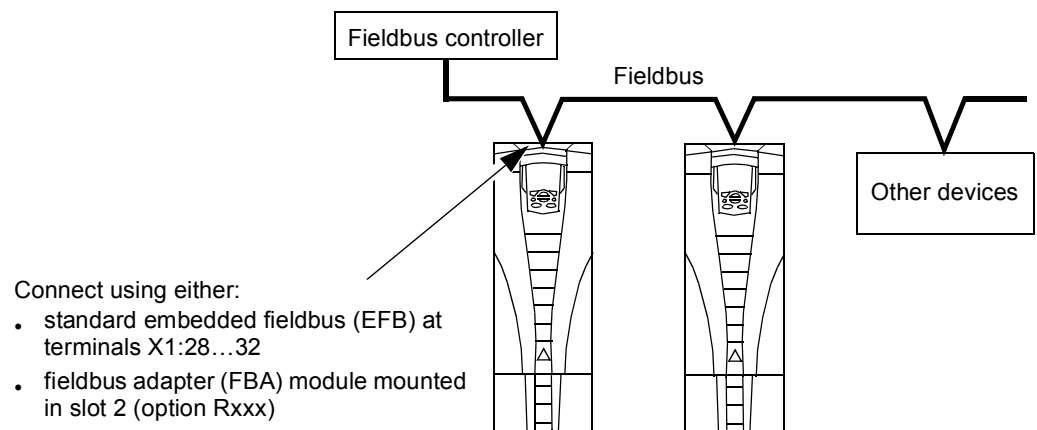

Two basic serial communications configurations are available:

- embedded fieldbus (EFB) – See chapter [Embedded fieldbus](#) on page [203](#).
- fieldbus adapter (FBA) – With one of the optional FBA modules in the drive's expansion slot 2, the drive can communicate to a control system using one of the following protocols:
  - PROFIBUS DP
  - Ethernet (Modbus/TCP, EtherNet/IP, EtherCAT, PROFINET IO, POWERLINK)
  - CANopen
  - DeviceNet
  - ControlNet.

The ACS550 detects automatically which communication protocol is used by the plug-in fieldbus adapter. The default settings for each protocol assume that the profile used is the protocol's industry-standard drive profile (e.g. PROFIdrive for PROFIBUS, AC/DC Drive for DeviceNet). All of the FBA protocols can also be configured for the ABB Drives profile.

Configuration details depend on the protocol and profile used. These details are provided in a user's manual supplied with the FBA module.

Details for the ABB Drives profile (which apply for all protocols) are provided in section [ABB Drives profile technical data](#) on page [248](#).

## Control interface

In general, the basic control interface between the fieldbus system and the drive consists of:

- Output Words:
  - CONTROL WORD
  - REFERENCE (speed or frequency)
  - Others: The drive supports a maximum of 15 output words. Protocols limits may further restrict the total.
- Input Words:
  - STATUS WORD
  - Actual Value (speed or frequency)
  - Others: The drive supports a maximum of 15 input words. Protocols limits may further restrict the total.

---

**Note:** The words “output” and “input” are used as seen from the fieldbus controller point of view. For example an output describes data flow from the fieldbus controller to the drive and appears as an input from the drive point of view.

---

The meanings of the controller interface words are not restricted by the ACS550. However, the profile used may set particular meanings.

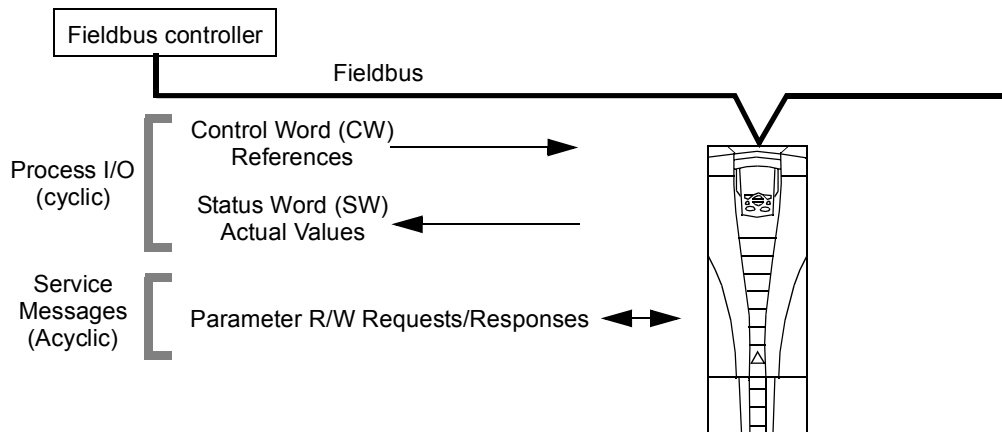

### Control Word

The CONTROL WORD is the principal means for controlling the drive from a fieldbus system. The fieldbus controller sends the CONTROL WORD to the drive. The drive switches between states according to the bit-coded instructions in the CONTROL WORD. Using the CONTROL WORD requires that:

- The drive is in remote (REM) control.
- The serial communication channel is defined as the source for controlling commands from EXT1 (set using parameters 1001 EXT1 COMMANDS and 1102 EXT1/EXT2 SEL).
- The external plug-in fieldbus adapter is activated:

- Parameter 9802 COMM PROT SEL = 4 (EXT FBA).
- The external plug-in fieldbus adapter is configured to use the drive profile mode or drive profile objects.

The content of the CONTROL WORD depends on the protocol/profile used. See the user's manual provided with the FBA module and/or section [ABB Drives profile technical data](#) on page 248.

### Status Word

The STATUS WORD is a 16-bit word containing status information, sent by the drive to the fieldbus controller. The content of the STATUS WORD depends on the protocol/profile used. See the user's manual provided with the FBA module and/or section [ABB Drives profile technical data](#) on page 248.

### Reference

The contents of each REFERENCE word:

- can be used, as speed or frequency reference
- is a 16-bit word comprised of a sign bit and a 15-bit integer
- Negative references (indicating reversed rotation direction) are indicated by the two's complement of the corresponding positive reference value.

The use of a second reference (REF2) is supported only when a protocol is configured for the ABB Drives profile.

Reference scaling is fieldbus type specific. See the user's manual provided with the FBA module and/or the following sections as appropriate:

- [Reference scaling](#) on page 252 ([ABB Drives profile technical data](#))
- [Reference scaling](#) on page 256 ([Generic profile technical data](#)).

### Actual Values

Actual Values are 16-bit words containing information on selected operations of the drive. Drive Actual Values (for example, [Group 10: START/STOP/DIR](#) parameters) can be mapped to Input Words using [Group 51: EXT COMM MODULE](#) parameters (protocol-dependent, but typically parameters 5104...5126).

## Planning

Network planning should address the following questions:

- What types and quantities of devices must be connected to the network?
- What control information must be sent down to the drives?
- What feedback information must be sent from the drives to the controlling system?

## Mechanical and electrical installation – FBA



**WARNING!** Connections should be made only while the drive is disconnected from the power source.

### Overview

The FBA (fieldbus adapter) is a plug-in module that fits in the drive's expansion slot 2. The module is held in place with plastic retaining clips and two screws. The screws also ground the shield for the module cable and connect the module GND signals to the drive control board.

On installation of the module, electrical connection to the drive is automatically established through the 34-pin connector.

### Mounting procedure

**Note:** Install the input power and motor cables first.

1. Insert the module carefully into the drive expansion slot 2 until the retaining clips lock the module into position.
2. Fasten the two screws (included) to the stand-offs.

**Note:** Correct installation of the screws is essential for fulfilling the EMC requirements and for proper operation of the module.

3. Open the appropriate knockout in the conduit box and install the cable clamp for the network cable.
4. Route the network cable through the cable clamp.
5. Connect the network cable to the module's network connector.
6. Tighten the cable clamp.
7. Install the conduit box cover (1 screw).
8. For configuration information see the following:
  - section [Communication set-up – FBA](#) on page 241
  - section [Activate drive control functions – FBA](#) on page 241
  - The protocol specific documentation provided with the module.

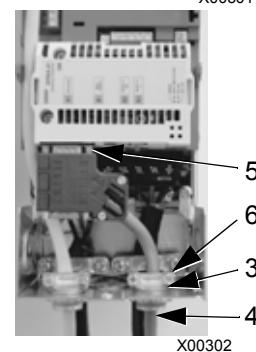
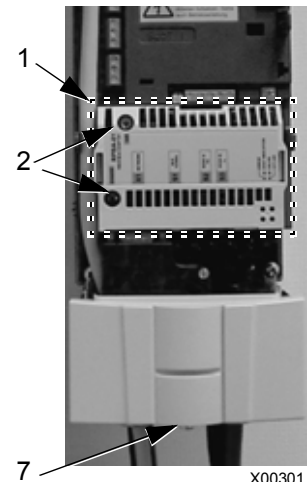



## Communication set-up – FBA

### Serial communication selection

To activate the serial communication, use parameter 9802 COMM PROT SEL. Set 9802 = 4 (EXT FBA).

### Serial communication configuration

Setting 9802, together with mounting a particular FBA module, automatically sets the appropriate default values in parameters that define the communication process. These parameters and descriptions are defined in the user's manual supplied with the FBA module.

- Parameter 5101 is automatically configured.
- Parameters 5102...5126 are protocol-dependent and define, for example, the profile used and additional I/O words. These parameters are referred to as the fieldbus configuration parameters. See the user's manual provided with the FBA module for details on the fieldbus configuration parameters.
- Parameter 5127 forces the validation of changes to parameters 5102...5126. If parameter 5127 is not used, changes to parameters 5102...5126 take affect only after the drive power is cycled.
- Parameters 5128...5133 provide data about the FBA module currently installed (e.g. component versions and status).

See [Group 51: EXT COMM MODULE](#) for parameter descriptions.

## Activate drive control functions – FBA

Fieldbus control of various drive functions requires configuration to:

- tell the drive to accept fieldbus control of the function
- define as a fieldbus input, any drive data required for control
- define as a fieldbus output, any control data required by the drive.

The following sections describe, at a general level, the configuration required for each control function. The last column in each table below is deliberately blank. See the user's manual supplied with the FBA module for the appropriate entry.

### Start/Stop Direction control

Using the fieldbus for start/stop/direction control of the drive requires:

- drive parameter values set as defined below
- fieldbus controller supplied command(s) in the appropriate location. (The location is defined by the Protocol Reference, which is protocol dependent.)

Drive parameter		Value	Description	Protocol reference
1001	EXT1 COMMANDS	10 (COMM)	Start/Stop controlled by fieldbus with Ext1 selected.	

Drive parameter		Value	Description	Protocol reference
1002	EXT2 COMMANDS	10 (COMM)	Start/Stop by controlled fieldbus with Ext2 selected.	
1003	DIRECTION	3 (REQUEST)	Direction controlled by fieldbus.	

### Input reference select

Using the fieldbus to provide input reference to the drive requires:

- drive parameter value set as defined below
- fieldbus controller supplied reference word(s) in the appropriate location. (The location is defined by the Protocol Reference, which is protocol dependent.)

Drive parameter		Value	Description	Protocol reference
1102	EXT1/EXT2 SEL	8 (COMM)	Ref. selected by fieldbus. (Required only if 2 references used.)	
1103	REF1 SELECT	8 (COMM) 9 (COMM+AI1) 10 (COMM*AI1)	Input reference 1 supplied by fieldbus.	
1106	REF2 SELECT	8 (COMM) 9 (COMM+AI) 10 (COMM*AI)	Input reference 2 supplied by fieldbus. (Required only if 2 references used.)	

---

**Note:** Multiple references are supported only when using the ABB Drives profile.

---

### Scaling

Where required, REFERENCES can be scaled. See the following sections, as appropriate:

- [Reference scaling](#) on page 252 (*ABB Drives profile technical data*)
- [Reference scaling](#) on page 256 (*Generic profile technical data*).

### System control

Using the fieldbus for miscellaneous drive control requires:

- drive parameter values set as defined below
- fieldbus controller command(s) in the appropriate location. (The location is defined by the Protocol Reference, which is protocol dependent.)

Drive parameter		Value	Description	Protocol reference
1601	RUN ENABLE	7 (COMM)	Run enable by fieldbus.	
1604	FAULT RESET SEL	8 (COMM)	Fault reset by fieldbus.	
1607	PARAM SAVE	1 (SAVE)	Saves altered parameters to memory (then value returns to 0).	

## Relay output control

Using the fieldbus for relay output control requires:

- drive parameter values set as defined below
- fieldbus controller supplied, binary coded, relay command(s) in the appropriate location. (The location is defined by the Protocol Reference, which is protocol dependent.)

Drive parameter		Value	Description	Protocol reference
1401	RELAY OUTPUT 1	35 (COMM)	Relay Output 1 controlled by fieldbus.	
1402	RELAY OUTPUT 2	36 (COMM(-1))	Relay Output 2 controlled by fieldbus.	
1403	RELAY OUTPUT 3		Relay Output 3 controlled by fieldbus.	
1410 <sup>1</sup>	RELAY OUTPUT 4		Relay Output 4 controlled by fieldbus.	
1411 <sup>1</sup>	RELAY OUTPUT 5		Relay Output 5 controlled by fieldbus.	
1412 <sup>1</sup>	RELAY OUTPUT 6		Relay Output 6 controlled by fieldbus.	

<sup>1</sup> More than 3 relays requires the addition of a relay extension module.

**Note:** Relay status feedback occurs without configuration as defined below.

Drive parameter		Value	Protocol reference
0122	RO 1-3 STATUS	Relay 1...3 status.	
0123	RO 4-6 STATUS	Relay 4...6 status.	

## Analog output control

Using the fieldbus for analog output control (e.g. PID setpoint) requires:

- drive parameter values set as defined below
- fieldbus controller supplied analog value(s) in the appropriate location. (The location is defined by the Protocol Reference, which is protocol dependent.)

Drive parameter		Value	Description	Protocol reference
1501	AO1 CONTENT SEL	135 (COMM VALUE 1)	Analog Output 1 controlled by writing to parameter 0135.	–
0135	COMM VALUE 1	–		
1502 ... 1505	AO1 CONTENT MIN ... MAXIMUM AO1	Set appropriate values.	Used for scaling	–
1506	FILTER AO1		Filter time constant for AO1.	
1507	AO2 CONTENT SEL		136 (COMM VALUE 2)	
0136	COMM VALUE 2	–		
1508 ... 1511	AO2 CONTENT MIN ... MAXIMUM AO2	Set appropriate values.	Used for scaling	–
1512	FILTER AO2		Filter time constant for AO2.	

## PID Control setpoint source

Using the following settings to select the fieldbus as the setpoint source for PID loops:

Drive parameter		Value	Setting	Protocol reference
4010	SET POINT SEL (Set 1)	8 (COMM VALUE 1)	Setpoint is input reference 2 (+/-/* AI1)	
4110	SET POINT SEL (Set 2)	9 (COMM+AI1)		
4210	SET POINT SEL (Ext/Trim)	10 (COMM*AI1)		

## Communication fault

When using fieldbus control, specify the drive's action if serial communication is lost.

Drive parameter		Value	Description
3018	COMM FAULT FUNC	0 (NOT SEL) 1 (FAULT) 2 (CONST SP7) 3 (LAST SPEED)	Set for appropriate drive response.
3019	COMM FAULT TIME	Set time delay before acting on a communication loss.	

## Feedback from the drive – FBA

Inputs to the controller (drive outputs) have pre-defined meanings established by the protocol. This feedback does not require drive configuration. The following table lists a sample of feedback data. For a complete listing, see all parameters listed in section [Complete parameter descriptions](#) on page 106.

Drive parameter		Protocol reference
0102	SPEED	
0103	OUTPUT FREQ	
0104	CURRENT	
0105	TORQUE	
0106	POWER	
0107	DC BUS VOLTAGE	
0109	OUTPUT VOLTAGE	
0301	FB CMD WORD 1 – bit 0 (STOP)	
0301	FB CMD WORD 1 – bit 2 (REV)	
0118	DI 1-3 STATUS – bit 0 (DI3)	

## Scaling

To scale the drive parameter values see the following sections, as appropriate:

- [Actual Value scaling](#) on page 255 (*ABB Drives profile technical data*)
- [Actual Value scaling](#) on page 257 (*Generic profile technical data*).

## Diagnostics – FBA

### Fault handling

The ACS550 provides fault information as follows:

- The control panel display shows a fault code and text. See chapter [Diagnostics](#) on page [259](#) for a complete description.
- Parameters 0401 LAST FAULT, 0412 PREVIOUS FAULT1 and 0413 PREVIOUS FAULT2 store the most recent faults.
- For fieldbus access, the drive reports faults as a hexadecimal value, assigned and coded according to the DRIVECOM specification. See the table below. Not all profiles support requesting fault codes using this specification. For profiles that support this specification, the profile documentation defines the proper fault request process.

Drive fault code		Fieldbus fault code (DRIVECOM specification)
1	OVERCURRENT	2310h
2	DC OVERVOLT	3210h
3	DEV OVERTEMP	4210h
4	SHORT CIRC	2340h
5	Reserved	FF6Bh
6	DC UNDERVOLT	3220h
7	AI1 LOSS	8110h
8	AI2 LOSS	8110h
9	MOT OVERTEMP	4310h
10	PANEL LOSS	5300h
11	ID RUN FAIL	FF84h
12	MOTOR STALL	7121h
14	EXT FAULT 1	9000h
15	EXT FAULT 2	9001h
16	EARTH FAULT	2330h
17	Obsolete	FF6Ah
18	THERM FAIL	5210h
19	OPEX LINK	7500h
20	OPEX PWR	5414h
21	CURR MEAS	2211h
22	SUPPLY PHASE	3130h
23	ENCODER ERR	7301h
24	OVERSPEED	7310h
25	Reserved	FF80h
26	DRIVE ID	5400h

Drive fault code		Fieldbus fault code (DRIVECOM specification)
27	CONFIG FILE	630Fh
28	SERIAL 1 ERR	7510h
29	EFB CON FILE	6306h
30	FORCE TRIP	FF90h
31	EFB 1	FF92h
32	EFB 2	FF93h
33	EFB 3	FF94h
34	MOTOR PHASE	FF56h
35	OUTP WIRING	FF95h
36	INCOMPATIBLE SW	630Fh
37	CB OVERTEMP	4110h
38	USER LOAD CURVE	FF6Bh
101	SERF CORRUPT	FF55h
102	Reserved	FF55h
103	SERF MACRO	FF55h
104	Reserved	FF55h
105	Reserved	FF55h
201	DSP T1 OVERLOAD	6100h
202	DSP T2 OVERLOAD	6100h
203	DSP T3 OVERLOAD	6100h
204	DSP STACK ERROR	6100h
205	Reserved (obsolete)	5000h
206	CB ID ERROR	5000h
207	EFB LOAD ERROR	6100h
1000	PAR HZRPM	6320h
1001	PAR PFC REF NEG	6320h
1002	Reserved (obsolete)	6320h
1003	PAR AI SCALE	6320h
1004	PAR AO SCALE	6320h
1005	PAR PCU 2	6320h
1006	PAR EXT RO	6320h
1007	PAR FIELDBUS MISSING	6320h
1008	PAR PFC MODE	6320h
1009	PAR PCU 1	6320h
1012	PAR PFC IO 1	6320h
1013	PAR PFC IO 2	6320h
1014	PAR PFC IO 3	6320h
1016	PAR USER LOAD C	6320h

### **Serial communication diagnostics**

Besides the drive fault codes, the FBA module has diagnostic tools. Refer to the user's manual supplied with the FBA module.

## ABB Drives profile technical data

### Overview

The ABB Drives profile provides a standard profile that can be used on multiple protocols, including protocols available on the FBA module. This section describes the ABB Drives profile implemented for FBA modules.

### Control Word

As described earlier in section [Control interface](#) on page 238, the CONTROL WORD is the principal means for controlling the drive from a fieldbus system.

The following table and the state diagram later in this sub-section describe the CONTROL WORD content for the ABB Drives profile.

ABB Drives profile (FBA) CONTROL WORD				
Bit	Name	Value	Commanded state	Comments
0	OFF1 CONTROL	1	READY TO OPERATE	Enter READY TO OPERATE
		0	EMERGENCY OFF	Drive ramps to stop according to currently active deceleration ramp (2203 or 2205) Normal command sequence: <ul style="list-style-type: none"> <li>• Enter OFF1 ACTIVE</li> <li>• Proceed to READY TO SWITCH ON, unless other interlocks (OFF2, OFF3) are active.</li> </ul>
1	OFF2 CONTROL	1	OPERATING	Continue operation (OFF2 inactive)
		0	EMERGENCY OFF	Drive coasts to stop. Normal command sequence: <ul style="list-style-type: none"> <li>• Enter OFF2 ACTIVE</li> <li>• Proceed to SWITCHON INHIBITED</li> </ul>
2	OFF3 CONTROL	1	OPERATING	Continue operation (OFF3 inactive)
		0	EMERGENCY STOP	Drive stops within in time specified by parameter 2208. Normal command sequence: <ul style="list-style-type: none"> <li>• Enter OFF3 ACTIVE</li> <li>• Proceed to SWITCH ON INHIBITED</li> </ul>  <b>WARNING!</b> Be sure motor and driven equipment can be stopped using this mode.
3	INHIBIT OPERATION	1	OPERATION ENABLED	Enter OPERATION ENABLED (Note the Run enable signal must be active. See 1601. If 1601 is set to COMM, this bit also activates the Run Enable signal.)
		0	OPERATION INHIBITED	Inhibit operation. Enter OPERATION INHIBITED
4	RAMP_OUT_ZERO	1	NORMAL OPERATION	Enter RAMP FUNCTION GENERATOR: ACCELERATION ENABLED
		0	RFG OUT ZERO	Force ramp function generator output to Zero. Drive ramps to stop (current and DC voltage limits in force).



ABB Drives profile (FBA) CONTROL WORD				
Bit	Name	Value	Commanded state	Comments
5	RAMP_HOLD	1	RFG OUT ENABLED	Enable ramp function. Enter RAMP FUNCTION GENERATOR: ACCELERATOR ENABLED
		0	RFG OUT HOLD	Halt ramping (Ramp Function Generator output held)
6	RAMP_IN_ZERO	1	RFG INPUT ENABLED	Normal operation. Enter OPERATING
		0	RFG INPUT ZERO	Force Ramp Function Generator input to zero.
7	RESET	0=>1	RESET	Fault reset if an active fault exists (Enter SWITCH-ON INHIBITED). Effective if 1604 = COMM.
		0	OPERATING	Continue normal operation
8...9	Unused			
10	REMOTE_CMD	1		Fieldbus control enabled
		0		<ul style="list-style-type: none"> <li>CW ≠ 0 or Ref ≠ 0: Retain last CW and Ref.</li> <li>CW = 0 and Ref = 0: Fieldbus control enabled.</li> <li>Ref and deceleration/acceleration ramp are locked.</li> </ul>
11	EXT CTRL LOC	1	EXT2 SELECT	Select external control location 2 (EXT2). Effective if 1102 = COMM.
		0	EXT1 SELECT	Select external control location 1 (EXT1). Effective if 1102 = COMM.
12...15	Unused			

### Status Word

As described earlier in section [Control interface](#) on page 238, the contents of the STATUS WORD is status information, sent by the drive to the master station. The following table and the state diagram later in this sub-section describe the status word content.

ABB Drives profile (FBA) STATUS WORD			
Bit	Name	Value	Description (Correspond to states/boxes in the state diagram)
0	RDY_ON	1	READY TO SWITCH ON
		0	NOT READY TO SWITCH ON
1	RDY_RUN	1	READY TO OPERATE
		0	OFF1 ACTIVE
2	RDY_REF	1	OPERATION ENABLED
		0	OPERATION INHIBITED
3	TRIPPED	0...1	FAULT
		0	No fault

ABB Drives profile (FBA) STATUS WORD			
Bit	Name	Value	Description (Correspond to states/boxes in the state diagram)
4	OFF_2_STA	1	OFF2 inactive
		0	OFF2 ACTIVE
5	OFF_3_STA	1	OFF3 inactive
		0	OFF3 ACTIVE
6	SWC_ON_INHIB	1	SWITCH-ON INHIBIT ACTIVE
		0	SWITCH-ON INHIBIT NOT ACTIVE
7	ALARM	1	Alarm (See section <a href="#">Alarm listing</a> on page 267 for details on alarms.)
		0	No alarm
8	AT_SETPOINT	1	OPERATING. Actual value equals (within tolerance limits) the reference value.
		0	Actual value is outside tolerance limits (not equal to reference value).
9	REMOTE	1	Drive control location: REMOTE (EXT1 or EXT2)
		0	Drive control location: LOCAL
10	ABOVE_LIMIT	1	Supervised parameter's value $\geq$ supervision high limit. Bit remains "1" until supervised parameter's value < supervision low limit. See <a href="#">Group 32: SUPERVISION</a> .
		0	Supervised parameter's value < supervision low limit. Bit remains "0" until supervised parameter's value > supervision high limit. See <a href="#">Group 32: SUPERVISION</a> .
11	EXT CTRL LOC	1	External control location 2 (EXT2) selected
		0	External control location 1 (EXT1) selected
12	EXT RUN ENABLE	1	External Run Enable signal received
		0	No External Run Enable signal received
13... 15	Unused		

The state diagram below describes the start-stop function of CONTROL WORD (CW) and STATUS WORD (SW) bits.

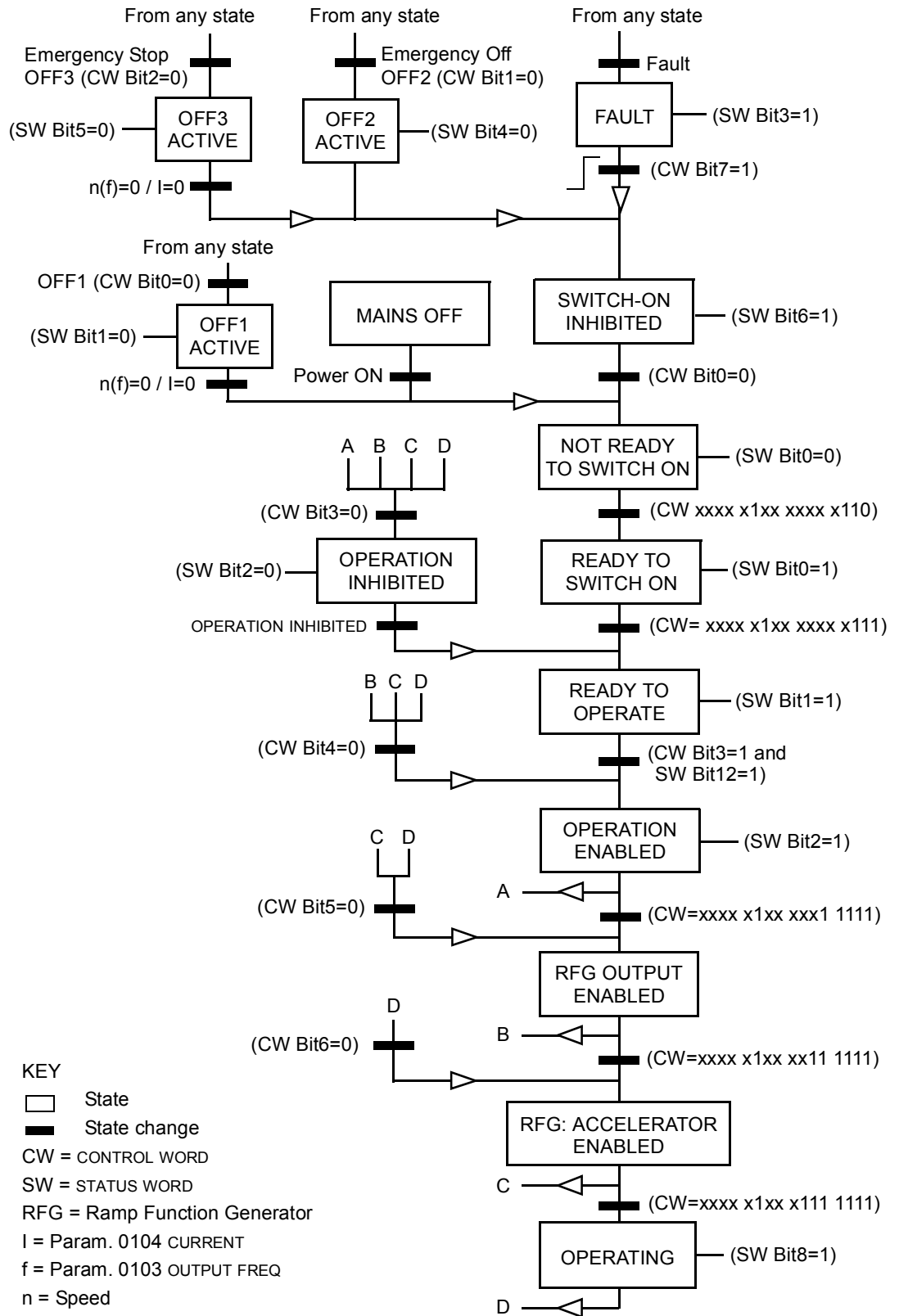

**Reference**

As described earlier in section *Control interface* on page 238, the REFERENCE word is a speed or frequency reference.

*Reference scaling*

The following table describes REFERENCE scaling for the ABB Drives profile.

ABB Drives Profile (FBA)				
Reference	Range	Reference type	Scaling	Remarks
REF1	-32767... +32767	Speed or frequency	-20000 = <b>-(par. 1105)</b> 0 = 0 +20000 = <b>(par. 1105)</b> (20000 corresponds to 100%)	Final reference limited by 1104/1105. Actual motor speed limited by 2001/2002 (speed) or 2007/2008 (frequency).
REF2	-32767... +32767	Speed or frequency	-10000 = <b>-(par. 1108)</b> 0 = 0 +10000 = <b>(par. 1108)</b> (10000 corresponds to 100%)	Final reference limited by 1107/1108. Actual motor speed limited by 2001/2002 (speed) or 2007/2008 (frequency).
		Torque	-10000 = <b>-(par. 1108)</b> 0 = 0 +10000 = <b>(par. 1108)</b> (10000 corresponds to 100%)	Final reference limited by 2015/2017 (torque1) or 2016/2018 (torque2).
		PID Reference	-10000 = <b>-(par. 1108)</b> 0 = 0 +10000 = <b>(par. 1108)</b> (10000 corresponds to 100%)	Final reference limited by 4012/4013 (PID set1) or 4112/4113 (PID set2).

**Note:** The setting of parameter 1104 REF1 MIN and 1107 REF2 MIN has no effect on the scaling of references.

When parameter 1103 REF1 SELECT or 1106 REF2 SELECT is set to COMM+AI1 or COMM\*AI1, the reference is scaled as follows:

ABB Drives profile (FBA)		
Reference	Value setting	AI reference scaling
REF1	COMM+AI1	$\text{COMM (\%)} + (\text{AI (\%)} - 0.5 \cdot \text{REF1 MAX (\%)})$

ABB Drives profile (FBA)		
Reference	Value setting	AI reference scaling
REF1	COMM*AI1	$\text{COMM (\%)} \cdot (\text{AI (\%)} / 0.5 \cdot \text{REF1 MAX (\%)})$
REF2	COMM+AI1	$\text{COMM (\%)} + (\text{AI (\%)} - 0.5 \cdot \text{REF2 MAX (\%)})$
REF2	COMM*AI1	$\text{COMM (\%)} \cdot (\text{AI (\%)} / 0.5 \cdot \text{REF2 MAX (\%)})$

Reference handling

Use *Group 10: START/STOP/DIR* parameters to configure for control of rotation direction for each control location (EXT1 and EXT2). The following diagrams illustrate how group 10 parameters and the sign of the fieldbus reference interact to produce REFERENCE values (REF1 and REF2). Note, fieldbus references are bipolar, that is they can be positive or negative.

ABB Drives profile		
Parameter	Value setting	AI reference scaling
1003 DIRECTION	1 (FORWARD)	
1003 DIRECTION	2 (REVERSE)	
1003 DIRECTION	3 (REQUEST)	

## Actual Value

As described earlier in section [Control interface](#) on page 238, Actual Values are words containing drive values.

### Actual Value scaling

The scaling of the integers sent to the fieldbus as Actual Values depends on the resolution of the selected drive parameter. Except as noted for ACT1 and ACT2 below, scale the feedback integer using the resolution listed for the parameter in section [Complete parameter list](#) on page 91. For example:

Feedback integer	Parameter resolution	Scaled Value
1	0.1 mA	$1 \cdot 0.1 \text{ mA} = 0.1 \text{ mA}$
10	0.1%	$10 \cdot 0.1\% = 1\%$

Data words 5 and 6 are scaled as follows:

ABB Drives profile		
	Contents	Scaling
ACT1	ACTUAL SPEED	$-20000 \dots +20000 = -(\text{par. } 1105) \dots +(\text{par. } 1105)$
ACT2	TORQUE	$-10000 \dots +10000 = -100\% \dots +100\%$

### Virtual addresses of the drive control

The virtual address area of the drive control is allocated as follows:

1	Control Word
2	Reference 1 (REF1)
3	Reference 2 (REF2)
4	Status Word
5	Actual Value 1 (ACT1)
6	Actual Value 2 (ACT2)

## Generic profile technical data

### Overview

The generic profile aims to fulfill the industry-standard drive profile for each protocol (e.g. PROFIdrive for PROFIBUS, AC/DC Drive for DeviceNet).

### Control Word

As described earlier in section [Control interface](#) on page 238, the CONTROL WORD is the principal means for controlling the drive from a fieldbus system. For specific CONTROL WORD content, see the user's manual provided with the FBA module.

### Status Word

As described earlier in section [Control interface](#) on page 238, the contents of the STATUS WORD is status information, sent by the drive to the master station. For specific STATUS WORD content, see the user's manual provided with the FBA module.

### Reference

As described earlier in section [Control interface](#) on page 238, the REFERENCE word is a speed or frequency reference.

---

**Note:** REF2 is not supported by the Generic Drive profiles.

---

### Reference scaling

REFERENCE scaling is fieldbus type specific. However, at the drive, the meaning of a 100% REFERENCE value is fixed as described in the table below. For a detailed description on the range and scaling of the REFERENCE, see the user's manual supplied with the FBA module.

Generic profile				
Reference	Range	Reference type	Scaling	Remarks
REF	Fieldbus specific	Speed	-100% = <b>-(par. 9908)</b> 0 = 0 +100 = <b>(par. 9908)</b>	Final reference limited by 1104/1105. Actual motor speed limited by 2001/2002 (speed).
		Frequency	-100% = <b>-(par. 9907)</b> 0 = 0 +100 = <b>(par. 9907)</b>	Final reference limited by 1104/1105. Actual motor speed limited by 2007/2008 (frequency).

### Actual Values

As described earlier in section [Control interface](#) on page 238, Actual Values are words containing drive values.



*Actual Value scaling*

For Actual Values, scale the feedback integer using the parameter's resolution. (See section [Complete parameter list](#) on page 91 for parameter resolutions.) For example:

Feedback integer	Parameter resolution	(Feedback integer) · (Parameter resolution) = Scaled Value
1	0.1 mA	1 · 0.1 mA = 0.1 mA
10	0.1%	10 · 0.1% = 1%

Where parameters are in percent, the [Complete parameter list](#) section specifies what parameter corresponds to 100%. In such cases, to convert from percent to engineering units, multiply by the value of the parameter that defines 100% and divide by 100%. For example:

Feedback integer	Parameter resolution	Value of the parameter that defines 100%	(Feedback integer) · (Parameter resolution) · (Value of 100% ref.) / 100% = Scaled Value
10	0.1%	1500 rpm <sup>1</sup>	10 · 0.1% · 1500 RPM / 100% = 15 rpm
100	0.1%	500 Hz <sup>2</sup>	100 · 0.1% · 500 Hz / 100% = 50 Hz

<sup>1</sup> Assuming, for the sake of this example, that the Actual Value uses parameter 9908 MOT NOM SPEED as the 100% reference and that 9908 = 1500 rpm.

<sup>2</sup> Assuming, for the sake of this example, that the Actual Value uses parameter 9907 MOT NOM FREQ as the 100% reference and that 9907 = 500 Hz.

*Actual Value mapping*

See the user's manual supplied with the FBA module.



# Diagnostics

---



**WARNING!** Do not attempt any measurement, parts replacement or other service procedure not described in this manual. Such action will void the warranty, may endanger correct operation and increase downtime and expense.

---



**WARNING!** All electrical installation and maintenance work described in this chapter should only be undertaken by qualified service personnel. The safety instructions in chapter [Safety instructions](#) on page 5 must be followed.

---

## Diagnostic displays

The drive detects error situations and reports them using:

- the green and red LED on the body of the drive
- the status LED on the control panel (if an Assistant Control Panel is attached to the drive)
- the control panel display (if a control panel is attached to the drive)
- the Fault Word and Alarm Word parameter bits (parameters 0305 to 0309). See [Group 03: FB ACTUAL SIGNALS](#) on page 112 for the bit definitions.

The form of the display depends on the severity of the error. You can specify the severity for many errors by directing the drive to:

- ignore the error situation
- report the situation as an alarm
- report the situation as a fault.

### Red – Faults

The drive signals that it has detected a severe error, or fault, by:

- enabling the red LED on the drive (LED is either steady on or blinking)
- showing the steady red status LED on the control panel (if attached to the drive)
- setting an appropriate bit in a Fault Word parameter (0305 to 0307)
- overriding the control panel display with the display of a fault code in the Fault mode (figures on the right)
- stopping the motor (if it was on).

The fault code on the control panel display is temporary. Pressing any of the following keys removes the fault message: MENU, ENTER, UP, or DOWN key.

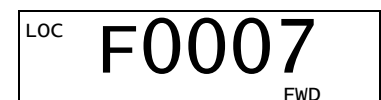
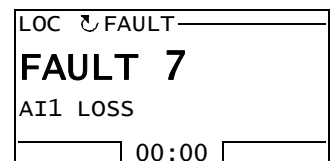

The message reappears after a few seconds if the control panel is not touched and the fault is still active.

**Flashing green – Alarms**

For less severe errors, called alarms, the diagnostic display is advisory. For these situations, the drive is simply reporting that it had detected something “unusual.” In these situations, the drive:

- flashes the green LED on the drive (does not apply to alarms that arise from control panel operation errors)
- flashes the green LED on the control panel (if attached to the drive)
- sets an appropriate bit in an Alarm Word parameter (0308 or 0309). See [Group 03: FB ACTUAL SIGNALS](#) on page 112 for the bit definitions
- overrides the control panel display with the display of an alarm code and/or name in the Fault mode (figures on the right).

Alarm messages disappear from the control panel display after a few seconds. The message returns periodically as long as the alarm condition exists.

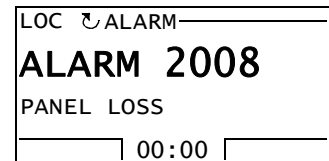

**Correcting faults**

The recommended corrective action for faults is:

- Use the table in section [Fault listing](#) below to find and address the root cause of the problem.
- Reset the drive. See section [Fault resetting](#) on page 265.

**Fault listing**

The following table lists the faults by code number and describes each. The fault name is the long form shown in the Fault mode of the Assistant Control Panel when the fault occurs. The fault names shown (for Assistant Control Panel only) in the Fault Logger mode (see page 61) and the fault names for parameter 0401 LAST FAULT may be shorter.

Fault code	Fault name in panel	Description and recommended corrective action
1	OVERCURRENT	Output current is excessive. Check for and correct: <ul style="list-style-type: none"> <li>• Excessive motor load.</li> <li>• Insufficient acceleration time (parameters 2202 ACCELER TIME 1 and 2205 ACCELER TIME 2).</li> <li>• Faulty motor, motor cables or connections.</li> </ul>

Fault code	Fault name in panel	Description and recommended corrective action
2	DC OVERVOLT	<p>Intermediate circuit DC voltage is excessive. Check for and correct:</p> <ul style="list-style-type: none"> <li>• Static or transient overvoltages in the input power supply.</li> <li>• Insufficient deceleration time (parameters 2203 DECELER TIME 1 and 2206 DECELER TIME 2).</li> <li>• Undersized brake chopper (if present).</li> <li>• Verify that overvoltage controller is ON (using parameter 2005).</li> </ul>
3	DEV OVERTEMP	<p>Drive heatsink is overheated. Temperature is at or above limit.  R1...R4: 115 °C (239 °F)  R5, R6: 125 °C (257 °F)</p> <p>Check for and correct:</p> <ul style="list-style-type: none"> <li>• Fan failure.</li> <li>• Obstructions in the air flow.</li> <li>• Dirt or dust coating on the heat sink.</li> <li>• Excessive ambient temperature.</li> <li>• Excessive motor load.</li> </ul>
4	SHORT CIRC	<p>Fault current. Check for and correct:</p> <ul style="list-style-type: none"> <li>• A short-circuit in the motor cable(s) or motor.</li> <li>• Supply disturbances.</li> </ul>
5	RESERVED	Not used.
6	DC UNDERVOLT	<p>Intermediate circuit DC voltage is not sufficient. Check for and correct:</p> <ul style="list-style-type: none"> <li>• Missing phase in the input power supply.</li> <li>• Blown fuse.</li> <li>• Undervoltage on mains.</li> </ul>
7	AI1 LOSS	<p>Analog input 1 loss. Analog input value is less than AI1 FAULT LIMIT (3021). Check for and correct:</p> <ul style="list-style-type: none"> <li>• Source and connection for analog input.</li> <li>• Parameter settings for AI1 FAULT LIMIT (3021) and 3001 AI&lt;MIN FUNCTION.</li> </ul>
8	AI2 LOSS	<p>Analog input 2 loss. Analog input value is less than AI2 FAULT LIMIT (3022). Check for and correct:</p> <ul style="list-style-type: none"> <li>• Source and connection for analog input.</li> <li>• Parameter settings for AI2 FAULT LIMIT (3022) and 3001 AI&lt;MIN FUNCTION.</li> </ul>
9	MOT OVERTEMP	<p>Motor is too hot, based on either the drive's estimate or on temperature feedback.</p> <ul style="list-style-type: none"> <li>• Check for overloaded motor.</li> <li>• Adjust the parameters used for the estimate (3005...3009).</li> <li>• Check the temperature sensors and <a href="#">Group 35: MOTOR TEMP MEAS</a> parameters.</li> </ul>
10	PANEL LOSS	<p>Panel communication is lost and either:</p> <ul style="list-style-type: none"> <li>• Drive is in local control mode (the control panel displays LOC), or</li> <li>• Drive is in remote control mode (REM) and is parameterized to accept start/stop, direction or reference from the control panel.</li> </ul> <p>To correct check:</p> <ul style="list-style-type: none"> <li>• Communication lines and connections.</li> <li>• Parameter 3002 PANEL COMM ERR.</li> <li>• Parameters in <a href="#">Group 10: START/STOP/DIR</a> and <a href="#">Group 11: REFERENCE SELECT</a> (if drive operation is REM).</li> </ul>

Fault code	Fault name in panel	Description and recommended corrective action
11	ID RUN FAIL	The Motor ID Run was not completed successfully. Check for and correct: <ul style="list-style-type: none"> <li>• Motor connections.</li> <li>• Motor parameters 9905...9909.</li> </ul>
12	MOTOR STALL	Motor or process stall. Motor is operating in the stall region. Check for and correct: <ul style="list-style-type: none"> <li>• Excessive load.</li> <li>• Insufficient motor power.</li> <li>• Parameters 3010...3012.</li> </ul>
13	RESERVED	Not used.
14	EXT FAULT 1	Digital input defined to report first external fault is active. See parameter 3003 EXTERNAL FAULT 1.
15	EXT FAULT 2	Digital input defined to report second external fault is active. See parameter 3004 EXTERNAL FAULT 2.
16	EARTH FAULT	Possible ground fault detected in the motor or motor cables. The drive monitors for ground faults while the drive is running and while the drive is not running. Detection is more sensitive when the drive is not running and can produce false positives. Possible corrections: <ul style="list-style-type: none"> <li>• Check for/correct faults in the input wiring.</li> <li>• Verify that motor cable does not exceed maximum specified length.</li> <li>• Decrease the detection level for earth fault with parameter 3028 EARTH FAULT LVL.</li> <li>• A delta grounded input power supply and motor cables with high capacitance may result in erroneous error reports during non-running tests. To disable response to fault monitoring when the drive is not running, use parameter 3023 WIRING FAULT. To disable response to all ground fault monitoring, use parameter 3017 EARTH FAULT.</li> </ul> <b>Note:</b> Disabling earth fault (ground fault) may void the warranty.
17	OBSOLETE	Not used.
18	THERM FAIL	Internal fault. The thermistor measuring the internal temperature of the drive is open or shorted. Contact your local ABB representative.
19	OPEX LINK	Internal fault. A communication-related problem has been detected on the fiber optic link between the control and OINT boards. Contact your local ABB representative.
20	OPEX PWR	Internal fault. Exceptionally low voltage detected on the OINT power supply. Contact your local ABB representative.
21	CURR MEAS	Internal fault. Current measurement is out of range. Contact your local ABB representative.
22	SUPPLY PHASE	Ripple voltage in the DC link is too high. Check for and correct: <ul style="list-style-type: none"> <li>• Missing mains phase.</li> <li>• Blown fuse.</li> </ul>

Fault code	Fault name in panel	Description and recommended corrective action
23	ENCODER ERR	<p>The drive is not detecting a valid encoder signal. Check for and correct:</p> <ul style="list-style-type: none"> <li>• Encoder presence and proper connection (reverse wired = channel A connected to terminal of channel B or vice versa, loose connection or short circuit).</li> <li>• Voltage logic levels are outside of the specified range.</li> <li>• A working and properly connected Pulse Encoder Interface Module, OTAC-01.</li> <li>• Wrong value entered in parameter 5001 PULSE NR. A wrong value will only be detected if the error is such that the calculated slip is greater than 4 times the rated slip of the motor.</li> <li>• Encoder is not being used, but parameter 5002 ENCODER ENABLE = 1 (ENABLE).</li> </ul>
24	OVERSPEED	<p>Motor speed is greater than 120% of the larger (in magnitude) of 2001 MINIMUM SPEED or 2002 MAXIMUM SPEED. Check for and correct:</p> <ul style="list-style-type: none"> <li>• Parameter settings for 2001 and 2002.</li> <li>• Adequacy of motor braking torque.</li> <li>• Applicability of torque control.</li> <li>• Brake chopper and resistor.</li> </ul>
25	RESERVED	Not used.
26	DRIVE ID	Internal fault. Configuration Block Drive ID is not valid. Contact your local ABB representative.
27	CONFIG FILE	Internal configuration file has an error. Contact your local ABB representative.
28	SERIAL 1 ERR	<p>Fieldbus communication has timed out. Check for and correct:</p> <ul style="list-style-type: none"> <li>• Fault setup (3018 COMM FAULT FUNC and 3019 COMM FAULT TIME).</li> <li>• Communication settings (<i>Group 51: EXT COMM MODULE</i> or <i>Group 53: EFB PROTOCOL</i> as appropriate).</li> <li>• Poor connections and/or noise on line.</li> </ul>
29	EFB CON FILE	Error in reading the configuration file for the embedded fieldbus.
30	FORCE TRIP	Fault trip forced by the fieldbus. See the fieldbus User's Manual.
31	EFB 1	Fault code reserved for the embedded fieldbus (EFB) protocol application. The meaning is protocol dependent.
32	EFB 2	
33	EFB 3	
34	MOTOR PHASE	<p>Fault in the motor circuit. One of the motor phases is lost. Check for and correct:</p> <ul style="list-style-type: none"> <li>• Motor fault.</li> <li>• Motor cable fault.</li> <li>• Thermal relay fault (if used).</li> <li>• Internal fault.</li> </ul>
35	OUTP WIRING	<p>Incorrect input power and motor cable connection (i.e., input power cable is connected to drive motor connection). The fault can be erroneously declared if the drive is faulty or the input power is a delta grounded system and the motor cable capacitance is large.</p> <p>This fault can be disabled by using parameter 3023 WIRING FAULT.</p> <ul style="list-style-type: none"> <li>• Check input power connections. Check grounding.</li> </ul>

<b>Fault code</b>	<b>Fault name in panel</b>	<b>Description and recommended corrective action</b>
36	INCOMPATIBLE SW	The drive cannot use the software. <ul style="list-style-type: none"> <li>• Internal fault.</li> <li>• The loaded software is not compatible with the drive.</li> <li>• Call support representative.</li> </ul>
37	CB OVERTEMP	Drive control board is overheated. The fault trip limit is 88 °C. Check for and correct: <ul style="list-style-type: none"> <li>• Excessive ambient temperature.</li> <li>• Fan failure.</li> <li>• Obstructions in the air flow.</li> </ul> Not for drives with an OMIO control board.
38	USER LOAD CURVE	Condition defined by parameter 3701 USER LOAD C MODE has been valid longer than the time defined by 3703 USER LOAD C TIME.
101... 199	SYSTEM ERROR	Error internal to the drive. Contact your local ABB representative and report the error number.
201... 299	SYSTEM ERROR	Error in the system. Contact your local ABB representative and report the error number.
-	UNKNOWN DRIVE TYPE: ACS550 SUPPORTED DRIVES: X	Wrong type of panel, i.e. panel that supports drive X but not the ACS550, has been connected to the ACS550.

Faults that indicate conflicts in the parameter settings are listed below.

<b>Fault code</b>	<b>Fault name in panel</b>	<b>Description and recommended corrective action</b>
1000	PAR HZRPM	Parameter values are inconsistent. Check for any of the following: <ul style="list-style-type: none"> <li>• 2001 MINIMUM SPEED &gt; 2002 MAXIMUM SPEED.</li> <li>• 2007 MINIMUM FREQ &gt; 2008 MAXIMUM FREQ.</li> <li>• 2001 MINIMUM SPEED / 9908 MOTOR NOM SPEED is outside proper range (&gt; 50).</li> <li>• 2002 MAXIMUM SPEED / 9908 MOTOR NOM SPEED is outside proper range (&gt; 50).</li> <li>• 2007 MINIMUM FREQ / 9907 MOTOR NOM FREQ is outside proper range (&gt; 50).</li> <li>• 2008 MAXIMUM FREQ / 9907 MOTOR NOM FREQ is outside proper range (&gt; 50).</li> </ul>
1001	PAR PFC REF NEG	Parameter values are inconsistent. Check for the following: <ul style="list-style-type: none"> <li>• 2007 MINIMUM FREQ is negative, when 8123 PFC ENABLE is active.</li> </ul>
1002	RESERVED	Not used.
1003	PAR AI SCALE	Parameter values are inconsistent. Check for any of the following: <ul style="list-style-type: none"> <li>• 1301 MINIMUM AI1 &gt; 1302 MAXIMUM AI1.</li> <li>• 1304 MINIMUM AI2 &gt; 1305 MAXIMUM AI2.</li> </ul>
1004	PAR AO SCALE	Parameter values are inconsistent. Check for any of the following: <ul style="list-style-type: none"> <li>• 1504 MINIMUM AO1 &gt; 1505 MAXIMUM AO1.</li> <li>• 1510 MINIMUM AO2 &gt; 1511 MAXIMUM AO2.</li> </ul>



Fault code	Fault name in panel	Description and recommended corrective action
1005	PAR PCU 2	Parameter values for power control are inconsistent: Improper motor nominal kVA or motor nominal power. Check for the following: <ul style="list-style-type: none"> <li><math>1.1 \leq (9906 \text{ MOTOR NOM CURR} \cdot 9905 \text{ MOTOR NOM VOLT} \cdot 1.73 / P_N) \leq 3.0</math> where: <math>P_N = 1000 \cdot 9909 \text{ MOTOR NOM POWER}</math> (if units are kW) or <math>P_N = 746 \cdot 9909 \text{ MOTOR NOM POWER}</math> (if units are hp, e.g. in US)</li> </ul>
1006	PAR EXT RO	Parameter values are inconsistent. Check for the following: <ul style="list-style-type: none"> <li>Extension relay module not connected and</li> <li>1410...1412 RELAY OUTPUTS 4...6 have non-zero values.</li> </ul>
1007	PAR FIELD BUS MISSING	Parameter values are inconsistent. Check for and correct: <ul style="list-style-type: none"> <li>A parameter is set for fieldbus control (e.g. 1001 EXT1 COMMANDS = 10 (COMM)), but 9802 COMM PROT SEL = 0.</li> </ul>
1008	PAR PFC MODE	Parameter values are inconsistent – 9904 MOTOR CTRL MODE must be = 3 (SCALAR:FREQ), when 8123 PFC ENABLE is activated.
1009	PAR PCU 1	Parameter values for power control are inconsistent: Improper motor nominal frequency or speed. Check for both of the following: <ul style="list-style-type: none"> <li><math>1 \leq (60 \cdot 9907 \text{ MOTOR NOM FREQ} / 9908 \text{ MOTOR NOM SPEED}) \leq 16</math></li> <li><math>0.8 \leq 9908 \text{ MOTOR NOM SPEED} / (120 \cdot 9907 \text{ MOTOR NOM FREQ} / \text{Motor Poles}) \leq 0.992</math></li> </ul>
1010/ 1011	RESERVED	Not used.
1012	PAR PFC IO 1	IO configuration is not complete – not enough relays are parameterized to PFC. Or, a conflict exists between <a href="#">Group 14: RELAY OUTPUTS</a> , parameter 8117 NR OF AUX MOT and parameter 8118 AUTOCHNG INTERV.
1013	PAR PFC IO 2	IO configuration is not complete – the actual number of PFC motors (parameter 8127, MOTORS) does not match the PFC motors in <a href="#">Group 14: RELAY OUTPUTS</a> and parameter 8118 AUTOCHNG INTERV.
1014	PAR PFC IO 3	IO configuration is not complete – the drive is unable to allocate a digital input (interlock) for each PFC motor (parameters 8120 INTERLOCKS and 8127 MOTORS).
1015	RESERVED	Not used.
1016	PAR USER LOAD C	Parameter values for the user load curve are inconsistent. Check that the following conditions are met: <ul style="list-style-type: none"> <li><math>3704 \text{ LOAD FREQ } 1 \leq 3707 \text{ LOAD FREQ } 2 \leq 3710 \text{ LOAD FREQ } 3 \leq 3713 \text{ LOAD FREQ } 4 \leq 3716 \text{ LOAD FREQ } 5</math>.</li> <li><math>3705 \text{ LOAD TORQ LOW } 1 \leq 3706 \text{ LOAD TORQ HIGH } 1</math>.</li> <li><math>3708 \text{ LOAD TORQ LOW } 2 \leq 3709 \text{ LOAD TORQ HIGH } 2</math>.</li> <li><math>3711 \text{ LOAD TORQ LOW } 3 \leq 3712 \text{ LOAD TORQ HIGH } 3</math>.</li> <li><math>3714 \text{ LOAD TORQ LOW } 4 \leq 3715 \text{ LOAD TORQ HIGH } 4</math>.</li> <li><math>3717 \text{ LOAD TORQ LOW } 5 \leq 3718 \text{ LOAD TORQ HIGH } 5</math>.</li> </ul>

### Fault resetting

The ACS550 can be configured to automatically reset certain faults. Refer to parameter [Group 31: AUTOMATIC RESET](#).



**WARNING!** If an external source for start command is selected and it is active, the ACS550 may start immediately after fault reset.

### Flashing red LED

To reset the drive for faults indicated by a flashing red LED:

- Turn the power off for 5 minutes.

### Red LED

To reset the drive for faults indicated by a red LED (on, not flashing), correct the problem and do one of the following:

- Press RESET from the control panel.
- Turn the power off for 5 minutes.

Depending on the value of 1604 FAULT RESET SEL, the following could also be used to reset the drive:

- digital input
- serial communication.

When the fault has been corrected, the motor can be started.

### History

For reference, the last three fault codes are stored into parameters 0401, 0412, 0413. For the most recent fault (identified by parameter 0401), the drive stores additional data (in parameters 0402...0411) to aid in troubleshooting a problem. For example, parameter 0404 stores the motor speed at the time of the fault.

The Assistant Control Panel provides additional information about the fault history. See section [Fault Logger mode](#) on page 61 for more information.

To clear the fault history (all of the [Group 04: FAULT HISTORY](#) parameters):

1. Using the control panel in the Parameters mode, select parameter 0401.
2. Press EDIT (or ENTER on the Basic Control Panel).
3. Press UP and DOWN at the same time.
4. Press SAVE.

## Correcting alarms

The recommended corrective action for alarms is:

- Determine if the alarm requires any corrective action (action is not always required).
- Use the table in section [Alarm listing](#) below to find and address the root cause of the problem.

## Alarm listing

The following table lists the alarms by code number and describes each.

Alarm code	Display	Description
2001	OVERCURRENT	Current limiting controller is active. Check for and correct: <ul style="list-style-type: none"> <li>Excessive motor load.</li> <li>Insufficient acceleration time (parameters 2202 ACCELER TIME 1 and 2205 ACCELER TIME 2).</li> <li>Faulty motor, motor cables or connections.</li> </ul>
2002	OVERVOLTAGE	Overvoltage controller is active. Check for and correct: <ul style="list-style-type: none"> <li>Static or transient overvoltages in the input power supply.</li> <li>Insufficient deceleration time (parameters 2203 DECELER TIME 1 and 2206 DECELER TIME 2).</li> </ul>
2003	UNDERVOLTAGE	Undervoltage controller is active. Check for and correct: <ul style="list-style-type: none"> <li>Undervoltage on mains.</li> </ul>
2004	DIR LOCK	The change in direction being attempted is not allowed. Either: <ul style="list-style-type: none"> <li>Do not attempt to change the direction of motor rotation, or</li> <li>Change parameter 1003 DIRECTION to allow direction change (if reverse operation is safe).</li> </ul>
2005	IO COMM	Fieldbus communication has timed out. Check for and correct: <ul style="list-style-type: none"> <li>Fault setup (3018 COMM FAULT FUNC and 3019 COMM FAULT TIME).</li> <li>Communication settings (<a href="#">Group 51: EXT COMM MODULE</a> or <a href="#">Group 53: EFB PROTOCOL</a> as appropriate).</li> <li>Poor connections and/or noise on line.</li> </ul>
2006	AI1 LOSS	Analog input 1 is lost, or value is less than the minimum setting. Check: <ul style="list-style-type: none"> <li>Input source and connections.</li> <li>Parameter that sets the minimum (3021).</li> <li>Parameter that sets the alarm/fault operation (3001),</li> </ul>
2007	AI2 LOSS	Analog input 2 is lost, or value is less than the minimum setting. Check: <ul style="list-style-type: none"> <li>Input source and connections.</li> <li>Parameter that sets the minimum (3022).</li> <li>Parameter that sets the alarm/fault operation (3001).</li> </ul>
2008	PANEL LOSS	Panel communication is lost and either: <ul style="list-style-type: none"> <li>Drive is in local control mode (the control panel displays LOC), or</li> <li>Drive is in remote control mode (REM) and is parameterized to accept start/stop, direction or reference from the control panel.</li> </ul> To correct check: <ul style="list-style-type: none"> <li>Communication lines and connections.</li> <li>Parameter 3002 PANEL COMM ERR.</li> <li>Parameters in <a href="#">Group 10: START/STOP/DIR</a> and <a href="#">Group 11: REFERENCE SELECT</a> (if drive operation is REM).</li> </ul>

Alarm code	Display	Description
2009	DEVICE OVERTEMP	Drive heatsink is hot. This alarm warns that a DEVICE OVERTEMP fault may be near. R1...R4: 100 °C (212 °F) R5, R6: 110 °C (230 °F) Check for and correct: <ul style="list-style-type: none"> <li>• Fan failure.</li> <li>• Obstructions in the air flow.</li> <li>• Dirt or dust coating on the heat sink.</li> <li>• Excessive ambient temperature.</li> <li>• Excessive motor load.</li> </ul>
2010	MOTOR TEMP	Motor is hot, based on either the drive's estimate or on temperature feedback. This alarm warns that a MOT OVERTEMP fault trip may be near. Check: <ul style="list-style-type: none"> <li>• Check for overloaded motor.</li> <li>• Adjust the parameters used for the estimate (3005...3009).</li> <li>• Check the temperature sensors and <a href="#">Group 35: MOTOR TEMP MEAS</a>.</li> </ul>
2011	RESERVED	Not used.
2012	MOTOR STALL	Motor is operating in the stall region. This alarm warns that a MOTOR STALL fault trip may be near.
2013 (Note 1)	AUTORESET	This alarm warns that the drive is about to perform an automatic fault reset, which may start the motor. <ul style="list-style-type: none"> <li>• To control automatic reset, use <a href="#">Group 31: AUTOMATIC RESET</a>.</li> </ul>
2014 (Note 1)	AUTOCHANGE	This alarm warns that the PFC autochange function is active. <ul style="list-style-type: none"> <li>• To control PFC, use <a href="#">Group 81: PFC CONTROL</a> and the <a href="#">PFC macro</a> on page <a href="#">84</a>.</li> </ul>
2015	PFC I LOCK	This alarm warns that the PFC interlocks are active, which means that the drive cannot start the following: <ul style="list-style-type: none"> <li>• Any motor (when Autochange is used).</li> <li>• The speed regulated motor (when Autochange is not used).</li> </ul>
2016/ 2017	RESERVED	Not used.
2018 (Note 1)	PID SLEEP	This alarm warns that the PID sleep function is active, which means that the motor could accelerate when the PID sleep function ends. <ul style="list-style-type: none"> <li>• To control PID sleep, use parameters 4022...4026 or 4122...4126.</li> </ul>
2019	ID RUN	Performing ID Run.
2020	RESERVED	Not used.
2021	START ENABLE 1 MISSING	This alarm warns that the Start Enable 1 signal is missing. <ul style="list-style-type: none"> <li>• To control Start Enable 1 function, use parameter 1608.</li> </ul> To correct, check: <ul style="list-style-type: none"> <li>• Digital input configuration.</li> <li>• Communication settings.</li> </ul>
2022	START ENABLE 2 MISSING	This alarm warns that the Start Enable 2 signal is missing. <ul style="list-style-type: none"> <li>• To control Start Enable 2 function, use parameter 1609.</li> </ul> To correct, check: <ul style="list-style-type: none"> <li>• Digital input configuration.</li> <li>• Communication settings.</li> </ul>

Alarm code	Display	Description
2023	EMERGENCY STOP	Emergency stop activated.
2024	ENCODER ERROR	The drive is not detecting a valid encoder signal. Check for and correct: <ul style="list-style-type: none"> <li>Encoder presence and proper connection (reverse wired, loose connection or short circuit).</li> <li>Voltage logic levels are outside of the specified range.</li> <li>A working and properly connected Pulse Encoder Interface Module, OTAC-01.</li> <li>Wrong value entered in parameter 5001 PULSE NR. A wrong value will only be detected if the error is such that the calculated slip is greater than 4 times the rated slip of the motor.</li> <li>Encoder is not being used, but parameter 5002 ENCODER ENABLE = 1 (ENABLE).</li> </ul>
2025	FIRST START	Signals that a the drive is performing a First Start evaluation of motor characteristics. This is normal the first time the motor is run after motor parameters are entered or changed. See parameter 9910 ID RUN for a description of motor models.
2026	RESERVED	Not used.
2027	USER LOAD CURVE	This alarm warns that the condition defined by parameter 3701 USER LOAD C MODE has been valid longer than half of the time defined by 3703 USER LOAD C TIME.
2028	START DELAY	Shown during the Start delay. See parameter 2113 START DELAY.

**Note 1.** Even when the relay output is configured to indicate alarm conditions (e.g. parameter 1401 RELAY OUTPUT 1 = 5 (ALARM) or 16 (FLT/ALARM)), this alarm is not indicated by a relay output.

### Alarm codes (Basic Control Panel)

The Basic Control Panel indicates control panel alarms with a code, A5xxx. The following table lists the alarm codes and descriptions.

Code	Description
5001	Drive is not responding.
5002	The communication profile is incompatible with the drive.
5010	The panel's parameter backup file is corrupted.
5011	Drive is controlled from another source.
5012	Rotation direction is locked.
5013	Button is disabled, because start is inhibited.
5014	Button is disabled, because drive is faulted.
5015	Button is disabled, because local mode lock is on.
5018	Parameter default value can't be found.
5019	Writing a non-zero value is prohibited (can only write a zero value).
5020	Group or parameter does not exist or parameter value is inconsistent.
5021	Group or parameter is hidden.
5022	Group or parameter is write protected.
5023	Modification is not allowed while the drive is running.

<b>Code</b>	<b>Description</b>
5024	Drive is busy, try again.
5025	Write is not allowed while upload or download is in progress.
5026	Value is at or below low limit.
5027	Value is at or above high limit.
5028	Value is invalid – doesn't match any values in the discrete values list.
5029	Memory is not ready, try again.
5030	Request is invalid.
5031	Drive is not ready, e.g due to low DC voltage.
5032	Parameter error was detected.
5040	Selected parameter set can't be found in the current parameter backup.
5041	Parameter backup doesn't fit into memory.
5042	Selected parameter set can't be found in the current parameter backup.
5043	No start inhibit was granted.
5044	Parameter backup versions do not match.
5050	Parameter upload was aborted.
5051	File error was detected.
5052	Parameter upload attempt has failed.
5060	Parameter download was aborted.
5062	Parameter download attempt has failed.
5070	Panel backup memory write error was detected.
5071	Panel backup memory read error was detected.
5080	Operation is not allowed, because the drive is not in local mode.
5081	Operation is not allowed, because a fault is active.
5083	Operation is not allowed, because parameter lock is not open.
5084	Operation is not allowed, because drive is busy, try again.
5085	Download is not allowed, because drive types are incompatible.
5086	Download is not allowed, because drive models are incompatible.
5087	Download is not allowed, because parameter sets do not match.
5088	Operation failed, because a drive memory error was detected.
5089	Download failed, because a CRC error was detected.
5090	Download failed, because a data processing error was detected.
5091	Operation failed, because a parameter error was detected.
5092	Download failed, because parameter sets do not match.

# Maintenance

---



**WARNING!** Read chapter [Safety instructions](#) on page 5 before performing any maintenance on the equipment. Ignoring the safety instructions can cause injury or death.

---

## Maintenance intervals

If installed in an appropriate environment, the drive requires very little maintenance. This table lists the routine maintenance intervals recommended by ABB.

Maintenance	Interval	Instruction
Heatsink temperature check and cleaning	Depends on the dustiness of the environment (every 6...12 months)	See <a href="#">Heatsink</a> on page 271.
Main cooling fan replacement	Every six years	See <a href="#">Main fan replacement</a> on page 272.
Internal enclosure cooling fan replacement (IP54 / UL type 12 drives)	Every three years.	See <a href="#">Internal enclosure fan replacement</a> on 274.
Capacitor reforming	Every year when stored	See <a href="#">Reforming</a> on page 275.
Capacitor replacement (frame sizes R5 and R6)	Every nine years	See <a href="#">Replacement</a> on page 275.
Replace battery in the Assistant Control Panel	Every ten years	See <a href="#">Battery</a> on page 275.

Consult your local ABB representative for more details on the maintenance. On the Internet, go to [www.abb.com/drives](http://www.abb.com/drives) and select *Service – Maintenance*.

## Heatsink

The heatsink fins accumulate dust from the cooling air. Since a dusty heatsink is less efficient at cooling the drive, overtemperature faults become more likely. In a “normal” environment (not dusty, not clean) check the heatsink annually, in a dusty environment check more often.

Clean the heatsink as follows (when necessary):

1. Remove power from the drive.
2. Remove the cooling fan (see section [Main fan replacement](#) on page 272).
3. Blow clean compressed air (not humid) from bottom to top and simultaneously use a vacuum cleaner at the air outlet to trap the dust.

---

**Note:** If there is a risk of the dust entering adjoining equipment, perform the cleaning in another room.

---

4. Reinstall the cooling fan.
5. Restore power.

## Main fan replacement

Fan failure can be predicted by the increasing noise from fan bearings and the gradual rise in the heatsink temperature in spite of heatsink cleaning. If the drive is operated in a critical part of a process, fan replacement is recommended once these symptoms start appearing. Replacement fans are available from ABB. Do not use other than ABB specified spare parts.

### Frame sizes R1...R4

To replace the fan:

1. Remove power from the drive.
2. Remove drive cover.
3. For frame size:
  - R1, R2: Press together the retaining clips on the fan cover sides, and lift.
  - R3, R4: Press in on the lever located on the left side of the fan mount, and rotate the fan up and out.
4. Disconnect the fan cable.
5. Reinstall the fan in reverse order.
6. Restore power.

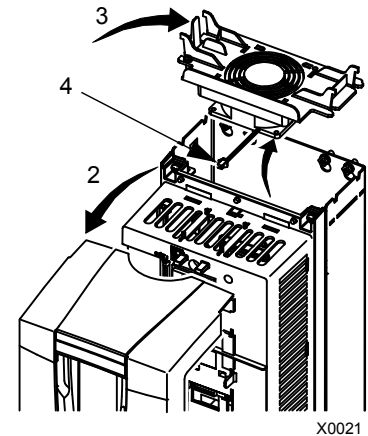

X0021

### Frame size R5

To replace the fan:

1. Remove power from drive.
2. Remove the screws attaching the fan.
3. Remove the fan: Swing the fan out on its hinges.
4. Disconnect the fan cable.
5. Reinstall the fan in reverse order.
6. Restore power.

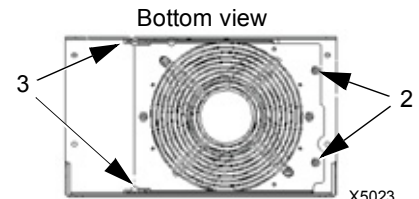

X5023

Arrows in the fan show the directions of the rotation and air flow.



**Frame size R6**

To replace the fan:

1. Remove power from the drive.
2. Remove the screw attaching the fan casing and let the casing lean down against the limiters.
3. Slide out the cable connector and disconnect it.
4. Take off the casing and replace the fan onto the casing's pins.
5. Reinstall the casing in reverse order.
6. Restore power.

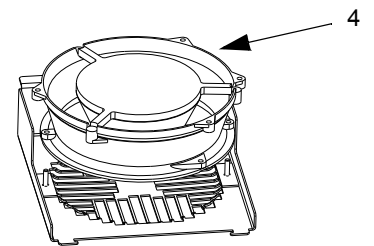
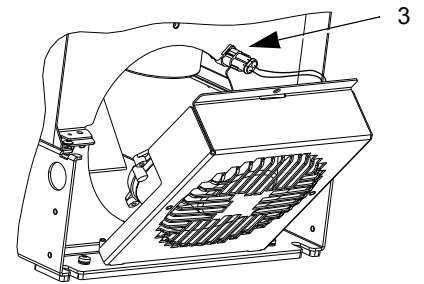
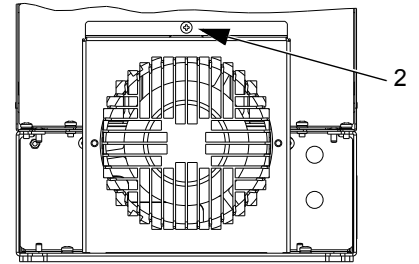

## Internal enclosure fan replacement

IP54 / UL type 12 enclosures have an additional internal fan to circulate air inside the enclosure.

### Frame sizes R1...R4

To replace the internal enclosure fan in frame sizes R1 to R3 (located at the top of the drive) and R4 (located in front of the drive):

1. Remove power from the drive.
2. Remove the front cover.
3. The housing that holds the fan in place has barbed retaining clips at each corner. Press all four clips toward the center to release the barbs.
4. When the clips/barbs are free, pull the housing up to remove from the drive.
5. Disconnect the fan cable.
6. Install the fan in reverse order, noting that:
  - The fan air flow is up (refer to the arrow on fan).
  - The fan wire harness is toward the front.
  - The notched housing barb is located in the right-rear corner.
  - The fan cable connects just forward of the fan at the top of the drive.

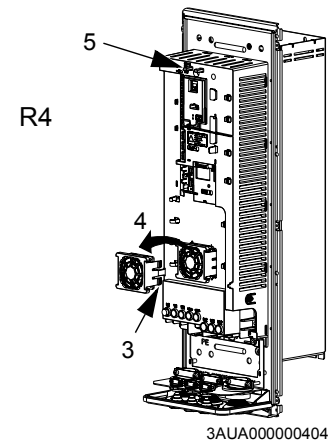
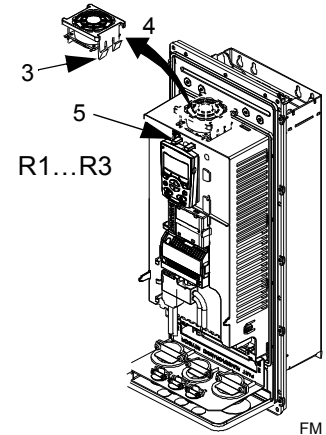

### Frame sizes R5 and R6

To replace the internal enclosure fan in frame sizes R5 or R6:

1. Remove power from the drive.
2. Remove the front cover.
3. Lift the fan out and disconnect the cable.
4. Install the fan in reverse order.
5. Restore power.

## Capacitors

### Reforming

The drive DC link capacitors need to be reformed (re-aged) if the drive has been non-operational for more than one year. Without reforming, capacitors may be damaged when the drive starts to operate. It is therefore recommended to reform the capacitors once a year. See section [Serial number](#) on page 17 for how to check the date of manufacture from the serial number shown on the drive labels.

For information on reforming the capacitors, refer to *Guide for Capacitor Reforming in ACS50, ACS55, ACS150, ACS310, ACS350, ACS355, ACS550, ACH550 and R1-R4 OINT-/SINTboards* (3AFE68735190 [English]), available on the Internet (go to [www.abb.com](http://www.abb.com) and enter the code in the Search field).

### Replacement

The drive intermediate circuit employs several electrolytic capacitors. Capacitor life can be prolonged by lowering the ambient temperature.

It is not possible to predict a capacitor failure. Capacitor failure is usually followed by a input power fuse failure or a fault trip. Contact ABB if capacitor failure is suspected. Replacements for frame size R5 and R6 are available from ABB. Do not use other than ABB specified spare parts.

## Control panel

### Cleaning

Use a soft damp cloth to clean the control panel. Avoid harsh cleaners which could scratch the display window.

### Battery

A battery is only used in Assistant Control Panels that have the clock function available and enabled. The battery keeps the clock operating in memory during power interruptions.

To remove the battery, use a coin to rotate the battery holder on the back of the control panel. Replace the battery with type CR2032.

---

**Note:** The battery is NOT required for any control panel or drive function, except the clock.

---



# Technical data

---

## Ratings

By type designation, the table below provides ratings for the ACS550 adjustable speed AC drive, including:

- IEC ratings
- NEMA ratings (shaded columns)
- frame size.

### Ratings, 208...240 V drives

Abbreviated column headers are described in section [Symbols](#) on page 279.

Type ACS550-x1- see below	Normal use			Heavy-duty use			Frame size
	$I_{2N}$ A	$P_N$ kW	$P_N$ hp	$I_{2hd}$ A	$P_{hd}$ kW	$P_{hd}$ hp	
Three-phase supply voltage, 208...240 V							
-04A6-2	4.6	0.75	1	3.5	0.55	0.75	R1
-06A6-2	6.6	1.1	1.5	4.6	0.75	1	R1
-07A5-2	7.5	1.5	2	6.6	1.1	1.5	R1
-012A-2	11.8	2.2	3	7.5	1.5	2	R1
-017A-2	16.7	4	5	11.8	2.2	3	R1
-024A-2	24.2	5.5	7.5	16.7	4	5	R2
-031A-2	30.8	7.5	10	24.2	5.5	7.5	R2
-046A-2	46.2	11	15	30.8	7.5	10	R3
-059A-2	59.4	15	20	46.2	11	15	R3
-075A-2	74.8	18.5	25	59.4	15	20	R4
-088A-2	88.0	22	30	74.8	18.5	25	R4
-114A-2	114	30	40	88.0	22	30	R4
-143A-2	143	37	50	114	30	40	R6
-178A-2	178	45	60	150	37	50	R6
-221A-2	221	55	75	178	45	60	R6
-248A-2	248	75	100	192	55	75	R6

00467918.xls C

## Ratings, 380...480 V drives

Abbreviated column headers are described in section [Symbols](#) on page 279.

Type	Normal use			Heavy-duty use			Frame size
	$I_{2N}$ A	$P_N$ kW	$P_N$ hp	$I_{2hd}$ A	$P_{hd}$ kW	$P_{hd}$ hp	
Three-phase supply voltage, 380...480 V							
-03A3-4	3.3	1.1	1.5	2.4	0.75	1	R1
-04A1-4	4.1	1.5	2	3.3	1.1	1.5	R1
-05A4-4	5.4	2.2	Note 1	4.1	1.5	Note 1	R1
-06A9-4	6.9	3	3	5.4	2.2	3	R1
-08A8-4	8.8	4	5	6.9	3	3	R1
-012A-4	11.9	5.5	7.5	8.8	4	5	R1
-015A-4	15.4	7.5	10	11.9	5.5	7.5	R2
-023A-4	23	11	15	15.4	7.5	10	R2
-031A-4	31	15	20	23	11	15	R3
-038A-4	38	18.5	25	31	15	20	R3
-045A-4	45	22	30	38	18.5	25	R3
-059A-4	59	30	40	44	22	30	R4
-072A-4	72	37	50	59	30	40	R4
-078A-4	77	Note 2	60	72	Note 2	50	R4
-087A-4	87	45	Note 1	72	37	Note 1	R4
-097A-4	97	Note 2	75	77	Note 2	60	R4
-125A-4	125	55	Note 1	87	45	Note 1	R5
-125A-4	125	Note 2	100	96	Note 2	75	R5
-157A-4	157	75	125	124	55	100	R6
-180A-4	180	90	150	156	75	125	R6
-195A-4	205	110	Note 1	162	90	Note 1	R6
-246A-4	246	132	200	192	110	150	R6
-290A-4	290	160	Note 1	246	132	200	R6

00467918.xls C

1. Not available in ACS550-U1 series.
2. Not available in ACS550-01 series.

## Ratings, 500...600 V drives

Abbreviated column headers are described in section [Symbols](#) on page 279.

Type	Normal use			Heavy-duty use			Frame size
	$I_{2N}$ A	$P_N$ kW	$P_N$ hp	$I_{2hd}$ A	$P_{hd}$ kW	$P_{hd}$ hp	
Three-phase supply voltage, 500...600 V (Note 1)							
-02A7-6	2.7	1.5	2	2.4	1.1	1.5	R2
-03A9-6	3.9	2.2	3	2.7	1.5	2	R2
-06A1-6	6.1	4	5	3.9	2.2	3	R2
-09A0-6	9.0	5.5	7.5	6.1	4	5	R2
-011A-6	11	7.5	10	9.0	5.5	7.5	R2
-017A-6	17	11	15	11	7.5	10	R2
-022A-6	22	15	20	17	11	15	R3
-027A-6	27	18.5	25	22	15	20	R3
-032A-6	32	22	30	27	18.5	25	R4
-041A-6	41	30	40	32	22	30	R4
-052A-6	52	37	50	41	30	40	R4
-062A-6	62	45	60	52	37	50	R4
-077A-6	77	55	75	62	45	60	R6
-099A-6	99	75	100	77	55	75	R6
-125A-6	125	90	125	99	75	100	R6
-144A-6	144	110	150	125	90	125	R6

00467918.xls C

1. Not available in ACS550-01 series.

## Symbols

### Typical ratings:

#### Normal use (10% overload capability)

$I_{2N}$  continuous rms current. 10% overload is allowed for one minute in ten minutes.

$P_N$  typical motor power in normal use. The kilowatt power ratings apply to most IEC, 4-pole motors. The horsepower ratings apply to most 4-pole NEMA motors.

#### Heavy-duty use (50% overload capability)

$I_{2hd}$  continuous rms current. 50% overload is allowed for one minute in ten minutes.

$P_{hd}$  typical motor power in heavy duty use. The kilowatt power ratings apply to most IEC, 4-pole motors. The horsepower ratings apply to most 4-pole NEMA motors.

## Sizing

The current ratings are the same regardless of the supply voltage within one voltage range. To achieve the rated motor power given in the table, the rated current of the drive must be higher than or equal to the rated motor current. Also note that:

- the ratings apply for ambient temperature of 40 °C (104 °F)
- the maximum allowed motor shaft power is limited to  $1.5 \cdot P_{hd}$ . If the limit is exceeded, motor torque and current are automatically restricted. The function protects the input bridge of the drive against overload.

In multimotor systems, the output current of the drive must be equal to or greater than the calculated sum of the input currents of all motors.

## Derating

The load capacity (current and power) decreases for certain situations, as defined below. In such situations, where full motor power is required, oversize the drive so that the derated value provides sufficient capacity.

For example, if your application requires 15.4 A of motor current and a 8 kHz switching frequency, calculate the appropriate drive size requirement as follows:

The minimum size required =  $15.4 \text{ A} / 0.80 = 19.25 \text{ A}$

Where: 0.80 is the derating for 8 kHz switching frequency (see section [Switching frequency derating](#) on page [280](#)).

Referring to  $I_{2N}$  in the ratings tables (starting from page [277](#)), the following drives exceed the  $I_{2N}$  requirement of 19.25 A: ACS550-x1-023A-4, or ACS550-x1-024A-2.

### Temperature derating

In the temperature range +40 °C...50 °C (+104 °F...122 °F), the rated output current is decreased 1% for every 1 °C (1.8 °F) above +40 °C (+104 °F). Calculate the output current by multiplying the current given in the rating table by the derating factor.

**Example** If the ambient temperature is 50 °C (+122 °F), the derating factor is  $100\% - 1\%/^{\circ}\text{C} \cdot 10^{\circ}\text{C} = 90\%$  or 0.90.

The output current is then  $0.90 \cdot I_{2N}$  or  $0.90 \cdot I_{2hd}$ .

### Altitude derating

In altitudes 1000...4000 m (3300...13,200 ft) above sea level, the derating is 1% for every 100 m (330 ft). If the installation site is higher than 2000 m (6600 ft) above sea level, contact your local ABB representative for further information.

### Single phase supply derating

For 208...240 V series drives, a single phase supply can be used. In that case, the derating is 50%.

### Switching frequency derating

When using the 8 kHz switching frequency (parameter 2606),

- derate all rated currents and powers (including drive's overload currents) to 80%.

When using the 12 kHz switching frequency (parameter 2606),

- derate all rated currents and powers (including drive's overload currents) to 65% (to 50% for 600 V, R4 frame sizes, that is for ACS550-U1-032A-6 ... ACS550-U1-062A-6),
- derate ambient temperature maximum to 30 °C (86 °F).
- Note: The continuous maximum current is limited to  $I_{2hd}$ .

**Note:** Setting parameter 2607 SWITCH FREQ CTRL = 1 (ON) allows the drive to reduce the switching frequency if/when the drive's internal temperature exceeds 80 °C (with 12 kHz switching frequency) or 90 °C (with 8 kHz switching frequency). See the parameter description for 2607 for details.



## Input power connections



**WARNING!** Do not operate the drive outside the nominal input line voltage range. Overvoltage can result in permanent damage to the drive.

### Input power specifications

Input power (mains) connection specifications	
<b>Voltage (<math>U_1</math>)</b>	208/220/230/240 V AC 3-phase (or 1-phase) -15%...+10% for ACS550-x1-xxxx-2. 380/400/415/440/460/480 V AC 3-phase -15%...+10% for ACS550-x1-xxxx-4. 500/525/575/600 V AC 3-phase -15%...+10% for ACS550-U1-xxxx-6.
<b>Prospective short-circuit current (IEC 629)</b>	Maximum allowed prospective short-circuit current in the supply is 100 kA providing that the input power cable of the drive is protected with appropriate fuses. US: 100 000 AIC.
<b>Frequency</b>	48...63 Hz
<b>Imbalance</b>	Max. $\pm$ 3% of nominal phase to phase input voltage
<b>Fundamental power factor (<math>\cos \phi_1</math>)</b>	0.98 (at nominal load)
<b>Cable temperature rating</b>	90 °C (194 °F) rating minimum

### Disconnecting device for isolation

Install a hand-operated input disconnecting device (disconnecting means) between the AC power source and the drive. The disconnecting device must be of a type that can be locked to the open position for installation and maintenance work.

- **Europe:** To meet the European Union Directives, according to standard EN 60204-1, Safety of Machinery, the disconnecting device must be one of the following types:
  - a switch-disconnector of utilization category AC-23B (EN 60947-3)
  - a disconnector having an auxiliary contact that in all cases causes switching devices to break the load circuit before the opening of the main contacts of the disconnector (EN 60947-3)
  - a circuit breaker suitable for isolation in accordance with EN 60947-2.
- **Other regions:** The disconnecting device must conform to the applicable safety regulations.

### Fuses

Branch circuit protection must be provided by the end user and sized per national and local electric codes. The following tables provide fuse recommendations for short circuit protection on the drive's input power.

**The rated fuse currents given in the tables are the maximums for the mentioned fuse types.** If smaller fuse ratings are used, check that the fuse rms current rating is larger than the input current.

**Check that the operating time of the fuse is below 0.5 seconds.** The operating time depends on the fuse type, the supply network impedance as well as the cross-sectional area, material and length of the supply cable. In case the 0.5 seconds operating time is exceeded with the gG or T fuses, ultra rapid (aR) fuses will in most cases reduce the operating time to an acceptable level.

*Fuses, 208...240 V drives*

ACS550-x1- see below	Input current A	Input power (mains) fuses		
		IEC 60269 gG (A)	UL Class T (A)	Bussmann type
-04A6-2	4.6	10	10	JJS-10
-06A6-2	6.6			
-07A5-2	7.5			
-012A-2	11.8	16	15	JJS-15
-017A-2	16.7	25	25	JJS-25
-024A-2	24.2		30	JJS-30
-031A-2	30.8	40	40	JJS-40
-046A-2	46.2	63	60	JJS-60
-059A-2	59.4		80	JJS-80
-075A-2	74.8	80	100	JJS-100
-088A-2	88.0	100	110	JJS-110
-114A-2	114	125	150	JJS-150
-143A-2	143	200	200	JJS-200
-178A-2	178	250	250	JJS-250
-221A-2	221	315	300	JJS-300
-248A-2	248		350	JJS-350

00467918.xls C

*Fuses, 380...480 V drives*

ACS550-x1- see below	Input current A	Input power (mains) fuses		
		IEC 60269 gG (A)	UL Class T (A)	Bussmann type
-03A3-4	3.3	10	10	JJS-10
-04A1-4	4.1			
-05A4-4	5.4			
-06A9-4	6.9			
-08A8-4	8.8			
-012A-4	11.9	16	15	JJS-15
-015A-4	15.4		20	JJS-20
-023A-4	23	25	30	JJS-30
-031A-4	31	35	40	JJS-40
-038A-4	38	50	50	JJS-50
-045A-4	45		60	JJS-60
-059A-4	59	63	80	JJS-80
-072A-4	72	80	90	JJS-90
-078A-4	77		100	JJS-100

ACS550-x1- see below	Input current A	Input power (mains) fuses		
		IEC 60269 gG (A)	UL Class T (A)	Bussmann type
-087A-4	87	125	125	JJS-125
-097A-4	97			
-125A-4	125	160	175	JJS-175
-157A-4	157	200	200	JJS-200
-180A-4	180	250	250	JJS-250
-195A-4	205			
-246A-4	246	315	350	JJS-350
-290A-4	290			

00467918.xls C

### Fuses, 500...600 V drives

ACS550-U1- see below	Input current A	Input power (mains) fuses		
		IEC 60269 gG (A)	UL Class T (A)	Bussmann type
-02A7-6	2.7	10	10	JJS-10
-03A9-6	3.9			
-06A1-6	6.1			
-09A0-6	9.0	16	15	JJS-15
-011A-6	11			
-017A-6	17	25	25	JJS-25
-022A-6	22			
-027A-6	27	35	40	JJS-40
-032A-6	32			
-041A-6	41	50	50	JJS-50
-052A-6	52	60	60	JJS-60
-062A-6	62	80	80	JJS-80
-077A-6	77		100	JJS-100
-099A-6	99	125	150	JJS-150
-125A-6	125	160	175	JJS-175
-144A-6	144	200	200	JJS-200

00467918.xls C

### Emergency stop devices

The overall design of the installation must include emergency stop devices and any other safety equipment that may be needed. Pressing STOP on the drive's control panel does NOT:

- generate an emergency stop of the motor
- separate the drive from dangerous potential.

## Input power cables/wiring

Input wiring can be any of:

- a four conductor cable (three phases and ground/protective earth). Shielding is not required.
- four insulated conductors routed through conduit.

Size wiring according to local safety regulations, appropriate input voltage and the drive's load current.

**Note:** The conductor must be less than the maximum limit defined by the terminal size. Check the maximum wire size according to the table in section [Drive's power connection terminals](#) on page 286.

The table below lists copper and aluminium cable types for different load currents. These recommendations apply only for the conditions listed at the top of the table.

IEC				NEC		
Based on:				Based on:		
<ul style="list-style-type: none"> <li>• EN 60204-1 and IEC 60364-5-2</li> <li>• PVC insulation</li> <li>• 30 °C (86 °F) ambient temperature</li> <li>• 70 °C (158 °F) surface temperature</li> <li>• cables with concentric copper shield</li> <li>• not more than nine cables laid on cable ladder side by side.</li> </ul>				<ul style="list-style-type: none"> <li>• NEC Table 310-16 for copper wires</li> <li>• 90 °C (194 °F) wire insulation</li> <li>• 40 °C (104 °F) ambient temperature</li> <li>• not more than three current-carrying conductors in raceway or cable, or earth (directly buried)</li> <li>• copper cables with concentric copper shield.</li> </ul>		
Max. load current A	Cu cable mm <sup>2</sup>		Max. load current A	Al cable mm <sup>2</sup>	Max. load current A	Cu wire size AWG/kcmil
14	3×1.5				22.8	14
20	3×2.5				27.3	12
27	3×4				36.4	10
34	3×6				50.1	8
47	3×10				68.3	6
62	3×16		61	3×25	86.5	4
79	3×25		75	3×35	100	3
98	3×35		91	3×50	118	2
119	3×50		117	3×70	137	1
153	3×70		143	3×95	155	1/0
186	3×95		165	3×120	178	2/0
215	3×120		191	3×150	205	3/0
249	3×150		218	3×185	237	4/0
284	3×185		257	3×240	264	250 MCM or 2 × 1
330	3×240		274	3× (3×50)	291	300 MCM or 2 × 1/0
			285	2× (3×95)	319	350 MCM or 2 × 2/0

### Ground connections

For personnel safety, proper operation and reduction of electromagnetic emission/pick-up, the drive and the motor must be grounded at the installation site.

- Conductors must be adequately sized as required by safety regulations.
- Power cable shields must be connected to the drive PE terminal in order to meet safety regulations.
- Power cable shields are suitable for use as equipment grounding conductors only when the shield conductors are adequately sized as required by safety regulations.
- In multiple drive installations, do not connect drive terminals in series.

#### Corner-grounded TN systems



**WARNING!** Do not attempt to install or remove the EMC filter screws EM1, EM3, F1 or F2 while power is applied to the drive's input terminals.

Corner-grounded TN systems are defined in the following table. In such systems, disconnect the internal ground connection through the EMC filter capacitors (do this also if the grounding configuration of the system is unknown), see section [Disconnecting the internal EMC filter](#) on page 27.

Corner-grounded TN systems – EMC filter must be disconnected			
Grounded at the corner of the delta		Grounded at the mid point of a delta leg	
Single phase, grounded at an end point		Three phase "Variac" without solidly grounded neutral	

The EMC filter capacitors make an internal ground connection that reduces electro-magnetic emission. Where EMC (electro-magnetic compatibility) is a concern, and the system is symmetrically grounded, the EMC filter may be connected. For reference, the diagram on the right illustrates a symmetrically grounded TN system (TN-S system).

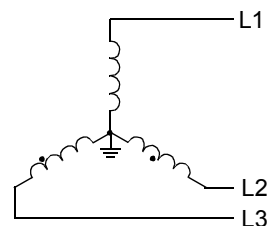

## IT systems



**WARNING!** Do not attempt to install or remove the EMC filter screws EM1, EM3, F1 or F2 while power is applied to the drive's input terminals.

For IT systems (an ungrounded power system or a high-resistance-grounded [over 30 ohm] power system):

- Disconnect the ground connection to the internal EMC filter, see section [Disconnecting the internal EMC filter](#) on page 27.
- Where EMC requirements exist, check for excessive emission propagated to neighboring low voltage networks. In some cases, the natural suppression in transformers and cables is sufficient. If in doubt, use a supply transformer with static screening between the primary and secondary windings.
- Do NOT install an external RFI/EMC filter. Using an EMC filter grounds the input power through the filter capacitors, which could be dangerous and could damage the drive.

## Drive's power connection terminals

The following table provides specifications for the drive's power connection terminals.

**Note:** See the recommended cable sizes for different load currents in section [Input power cables/wiring](#) on page 284.

Frame size	U1, V1, W1 U2, V2, W2 BRK±, UDC± terminals						Earthing PE terminal			
	Minimum wire size		Maximum wire size		Tightening torque		Maximum wire size		Tightening torque	
	mm <sup>2</sup>	AWG	mm <sup>2</sup>	AWG	N·m	lb·ft	mm <sup>2</sup>	AWG	N·m	lb·ft
R1	0.75	18	10	8	1.4	1	10	8	1.4	1
R2	0.75	18	10	8	1.4	1	10	8	1.4	1
R3	2.5	14	25	3	2.5	1.8	16	6	1.8	1.3
R4	6	10	50	1/0	5.6	4	25	3	2	1.5
R5	6	10	70	2/0	15	11	70	2/0	15	11
R6	95 <sup>1</sup>	3/0 <sup>1</sup>	240	350 MCM	40	30	95	3/0	8	6

00467918.xls C

<sup>1</sup> See section [Power terminal considerations – R6 frame size](#) on page 287.

### Power terminal considerations – R6 frame size



**WARNING!** For R6 power terminals, if screw-on terminal lugs are supplied, they can only be used for wire sizes that are 95 mm<sup>2</sup> (3/0 AWG) or larger. Smaller wires will loosen and may damage the drive. They require crimp-on ring lugs as described below.

#### Crimp-on ring lugs

On the R6 frame size, if screw-on terminal lugs are supplied but the cable size used is less than 95 mm<sup>2</sup> (3/0 AWG), or if no screw-on terminal lugs are supplied at all, use crimp-on ring lugs according to the following procedure.

1. Select appropriate ring lugs from the following table.
2. Remove the screw-on terminal lugs, if supplied.
3. Attach the ring lugs to the drive end of the cables.
4. Isolate the ends of the ring lugs with insulating tape or shrink tubing.
5. Attach the ring lugs to the drive.

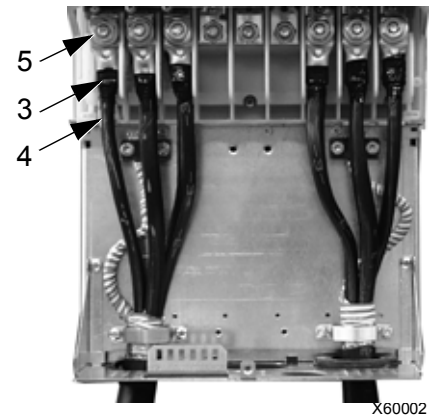

X60002

Wire size		Manufacturer	Ring lug	Crimping tool	No. of crimps
mm <sup>2</sup>	kcmil/ AWG				
16	6	Burndy	YAV6C-L2	MY29-3	1
		IlSCO	CCL-6-38	ILC-10	2
25	4	Burndy	YA4C-L4BOX	MY29-3	1
		IlSCO	CCL-4-38	MT-25	1
35	2	Burndy	YA2C-L4BOX	MY29-3	2
		IlSCO	CRC-2	IDT-12	1
		IlSCO	CCL-2-38	MT-25	1
50	1	Burndy	YA1C-L4BOX	MY29-3	2
		IlSCO	CRA-1-38	IDT-12	1
		IlSCO	CCL-1-38	MT-25	1
		Thomas & Betts	54148	TBM-8	3
55	1/0	Burndy	YA25-L4BOX	MY29-3	2
		IlSCO	CRB-0	IDT-12	1
		IlSCO	CCL-1/0-38	MT-25	1
		Thomas & Betts	54109	TBM-8	3

Wire size		Manufacturer	Ring lug	Crimping tool	No. of crimps
mm <sup>2</sup>	kcmil/ AWG				
70	2/0	Burndy	YAL26T38	MY29-3	2
		IlSCO	CRA-2/0	IDT-12	1
		IlSCO	CCL-2/0-38	MT-25	1
		Thomas & Betts	54110	TBM-8	3
95	3/0	Burndy	YAL27T38	MY29-3	2
		IlSCO	CRA-3/0	IDT-12	1
		IlSCO	CCL-3/0-38	MT-25	1
		Thomas & Betts	54111	TBM-8	3
95	3/0	Burndy	YA28R4	MY29-3	2
		IlSCO	CRA-4/0	IDT-12	1
		IlSCO	CCL-4/0-38	MT-25	2
		Thomas & Betts	54112	TBM-8	4

**Screw-on terminal lugs**

Use the following procedure to attach cables if screw-on terminal lugs are supplied and the cable size is 95 mm<sup>2</sup> (3/0 AWG) or larger.

1. Attach the supplied screw-on lugs to the drive end of the cables.
2. Attach screw-on lugs to the drive.

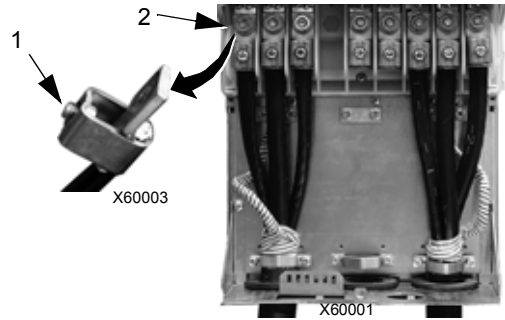



## Motor connections



**WARNING!** Never connect line power to the drive output terminals: U<sub>2</sub>, V<sub>2</sub> or W<sub>2</sub>. Line voltage applied to the output can result in permanent damage to the drive. If frequent bypassing is required, use mechanically interlocked switches or contactors.



**WARNING!** Do not connect any motor with a nominal voltage less than one half of the drive's nominal input voltage.



**WARNING!** Disconnect the drive before conducting any voltage tolerance (Hi-Pot) test or insulation resistance (Megger) test on the motor or motor cables. Do not conduct these tests on the drive.

### Motor connection specifications

Motor connection specifications														
<b>Voltage (<math>U_2</math>)</b>	0... $U_1$ , 3-phase symmetrical, $U_{max}$ at the field weakening point													
<b>Frequency</b>	0...500 Hz													
<b>Frequency resolution</b>	0.01 Hz													
<b>Current</b>	See section <a href="#">Ratings</a> on page 277.													
<b>Field weakening point</b>	10...500 Hz													
<b>Switching frequency</b>	Selectable. See the availability in the table below.													
		<table border="1"> <thead> <tr> <th></th> <th>1, 2, 4 and 8 kHz</th> <th>12 kHz</th> </tr> </thead> <tbody> <tr> <td>208...240 V</td> <td>All types</td> <td>Frame sizes R1...R4 in scalar control mode</td> </tr> <tr> <td>380...480 V</td> <td>All types</td> <td>Frame sizes R1...R4 (except ACS550-01-097A-4) in scalar control mode</td> </tr> <tr> <td>500...600 V</td> <td>All types</td> <td>Frame sizes R2...R4 in scalar control mode</td> </tr> </tbody> </table>		1, 2, 4 and 8 kHz	12 kHz	208...240 V	All types	Frame sizes R1...R4 in scalar control mode	380...480 V	All types	Frame sizes R1...R4 (except ACS550-01-097A-4) in scalar control mode	500...600 V	All types	Frame sizes R2...R4 in scalar control mode
		1, 2, 4 and 8 kHz	12 kHz											
	208...240 V	All types	Frame sizes R1...R4 in scalar control mode											
380...480 V	All types	Frame sizes R1...R4 (except ACS550-01-097A-4) in scalar control mode												
500...600 V	All types	Frame sizes R2...R4 in scalar control mode												
<b>Cable temperature rating</b>	90 °C (194 °F) rating minimum.													
<b>Maximum motor cable length</b>	See section <a href="#">Motor cable lengths</a> on page 289.													

### Motor cable lengths

Maximum motor cable lengths for 400 V and 600 V drives are given in the sections below.

In multimotor systems, the calculated sum of all motor cable lengths must not exceed the maximum motor cable length given in the appropriate table below.

### Motor cable length for 400 V drives

The table below shows the maximum motor cable lengths for 400 V drives with different switching frequencies. Examples for using the table are also given.

Maximum cable length for 400 V drives																				
Frame size	EMC limits												Operational limits							
	Second environment (category C3 <sup>1</sup> )						First environment (category C2 <sup>1</sup> )						Basic unit				With du/dt filters			
	1 kHz		4 kHz		8 kHz		1 kHz		4 kHz		8 kHz		1/4 kHz		8/12 kHz		m		ft	
	m	ft	m	ft	m	ft	m	ft	m	ft	m	ft	m	ft	m	ft	m	ft	m	ft
<b>R1</b>	300	980	300	980	300	980	300	980	300	980	300	980	100	330	100	330	150	490		
<b>R2</b>	300	980	300	980	300	980	300	980	100	330	30	98	200	660	100	330	250	820		
<b>R3</b>	300	980	300	980	300	980	300	980	75	245	75	245	200	660	100	330	250	820		
<b>R4</b>	300	980	300	980	300	980	300	980	75	245	75	245	200	660	100	330	300	980		
<b>R5</b>	100	330	100	330	100	330	100	330	100	330	100	330	300	980	150 <sup>2</sup>	490 <sup>2</sup>	300	980		
<b>R6</b>	100	330	100	330	<sup>3</sup>	<sup>3</sup>	100	330	100	330	<sup>3</sup>	<sup>3</sup>	300	980	150 <sup>2</sup>	490 <sup>2</sup>	300	980		

<sup>1</sup> See the new terms in section [IEC/EN 61800-3:2004 Definitions](#) on page 311.

<sup>2</sup> 12 kHz switching frequency is not available.

<sup>3</sup> Not tested.

Sine filters further extend the cable lengths.

Under heading “Operational limits”, the “Basic unit” columns define the cable lengths with which the basic drive unit works without problems within the drive specification, without installing any further options. Column “With du/dt filters” defines the cable lengths when an external du/dt filter is used.

The columns under heading “EMC limits” show the maximum cable lengths with which the units have been tested for EMC emissions. The factory guarantees that these cable lengths meet the EMC standard requirements.

If external sine filters are installed, longer cable lengths can be used. With sine filters the limiting factors are the voltage drop of the cable, which has to be taken into account in engineering, as well as the EMC limits (where applicable).

The default switching frequency is 4 kHz.



**WARNING!** Using a motor cable longer than specified in the table above may cause permanent damage to the drive.

Examples for using the table:

Requirements	Checking and conclusions
R1 frame size, 8 kHz fsw, Category C2, 150 m (490 ft) cable	Check operational limits for R1 and 8 kHz -> for a 150 m (490 ft) cable a du/dt filter is needed. Check EMC limits -> EMC requirements for Category C2 are met with a 150 m (490 ft) cable.

Requirements	Checking and conclusions
R3 frame size, 4 kHz fsw, Category C3, 300 m (980 ft) cable	Check operational limits for R3 and 4 kHz -> a 300 m (980 ft) cable cannot be used even with a du/dt filter. A sine filter must be used and the voltage drop of the cable must be taken into account in the installation.  Check EMC limits -> EMC requirements for Category C3 are met with a 300 m (980 ft) cable.
R5 frame size, 8 kHz fsw, Category C3, 150 m (490 ft) cable	Check operational limits for R5 and 8 kHz -> for a 150 m (490 ft) cable the basic unit is sufficient.  Check EMC limits -> EMC requirements for Category C3 cannot be met with a 300 m (980 ft) cable. The installation configuration is not possible. An EMC plan is recommended to overcome the situation.
R6 frame size, 4 kHz fsw, EMC limits not applicable, 150 m (490 ft) cable	Check operational limits for R6 and 4 kHz -> for a 150 m (490 ft) cable the basic unit is sufficient.  EMC limits do not need to be checked as there are no EMC requirements.

#### Motor cable length for 600 V drives

The table below shows the maximum motor cable lengths for 600 V drives with different switching frequencies. As the 600 V drives are not CE approved, cable lengths for EMC limits are not given.

Maximum cable length for 600 V drives				
Frame size	Operational limits			
	1/4 kHz		8/12 kHz	
	m	ft	m	ft
R2	100	330	100	330
R3...R4	200	660	100	330
R6	300	980	150 <sup>2</sup>	490 <sup>2</sup>

<sup>2</sup> 12 kHz switching frequency is not available.



**WARNING!** Using a motor cable longer than specified in the table above may cause permanent damage to the drive.

#### Motor thermal protection

According to regulations, the motor must be protected against thermal overload and the current must be switched off when overload is detected. The drive includes a motor thermal protection function that protects the motor and switches off the current when necessary. Depending on a drive parameter value (see parameter 3501 SENSOR TYPE), the function either monitors a calculated temperature value (based on a motor thermal model, see parameters 3005 MOT THERM PROT ... 3009 BREAK POINT FREQ) or an actual temperature indication given by motor temperature sensors (see [Group 35: MOTOR TEMP MEAS](#)). The user can tune the thermal model further by feeding in additional motor and load data.

The most common temperature sensors are:

- motor sizes IEC180...225: thermal switch (e.g. Klixon)
- motor sizes IEC200...250 and larger: PTC or PT100.

### Ground fault protection

ACS550 internal fault logic detects ground faults in the drive, motor, or motor cable. This fault logic:

- is NOT a personal safety or fire protection feature
  - can be disabled using parameter 3017 EARTH FAULT
- Note:** Disabling earth fault (ground fault) may void the warranty.
- could be tripped by leakage currents (input power to ground) associated with long high capacitance motor cables.

### Grounding and routing

#### *Motor cable shielding*

Motor cables require shielding using conduit, armored cable or shielded cable.

- Conduit – When using conduit:
  - Bridge joints with a ground conductor bonded to the conduit on each side of the joint.
  - Bond conduit run to the drive enclosure.
  - Use a separate conduit run for motor cables (also separate input power and control cables).
  - Use a separate conduit run for each drive.
- Armored cable – When using armored cable:
  - Use six-conductor (3 phases and 3 grounds), type MC continuous corrugated aluminium armor cable with symmetrical grounds.
  - Armored motor cable can share a cable tray with input power cables, but not with control cables.
- Shielded cable – For shielded cable details, see section [Motor cable requirements for CE & C-Tick compliance](#) on page 293.

#### *Grounding*

See section [Ground connections](#) on page 285.

For CE compliant installations and installations where EMC emissions must be minimized, see section [Effective motor cable shields](#) on page 294.

### Drive's motor connection terminals

The drive's motor and input power terminals have the same specifications. See section [Drive's power connection terminals](#) on page 286.

### Motor cable requirements for CE & C-Tick compliance

The requirements in this section apply for CE or C-Tick compliance.

#### Minimum requirement (CE & C-Tick)

The motor cable must be a symmetrical three conductor cable with a concentric PE conductor or a four conductor cable with a concentric shield, however, a symmetrical constructed PE conductor is always recommended. The following figure shows the minimum requirement for the motor cable shield (for example, MCMK, Draka NK Cables).

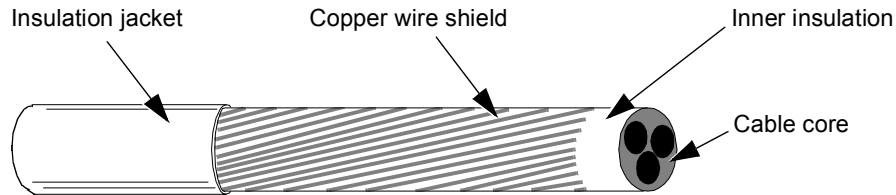

#### Recommendation for conductor layout

The following figure compares conductor layout features in motor cables.

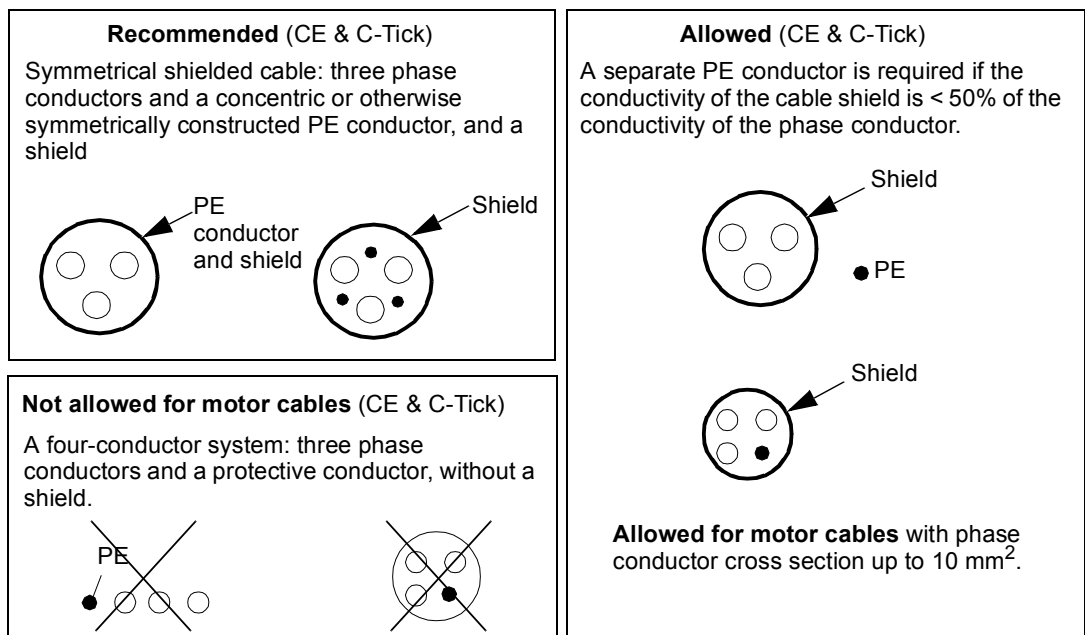

### Effective motor cable shields

The general rule for cable shield effectiveness is: the better and tighter the cable's shield, the lower the radiated emission level. The following figure shows an example of an effective construction (for example Ölflex-Servo-FD 780 CP, Lappkabel or MCCMK, NK Cables).

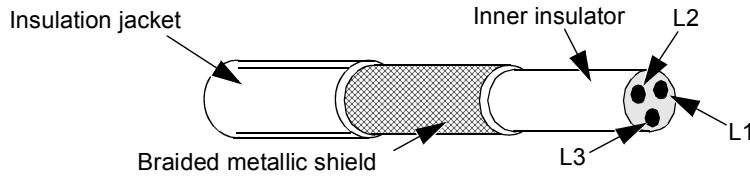

### EN 61800-3 compliant motor cables

The most efficient EMC filtering can be achieved by following these rules:

- Motor cables must have an effective shield as described in section [Effective motor cable shields](#) on page 294.
- Motor cable shield wires must be twisted together into a bundle (pig-tail) – the bundle length must be less than five times its width – and connected to the terminal marked  $\perp$  (at the bottom right-hand corner of the drive).
- At the motor end, the motor cable shield must be earthed 360 degrees with an EMC cable gland, or the shield wires must be twisted together into a bundle (pig-tail) not longer than five times its width and connected to the PE terminal of the motor.
- See section [Motor cable length for 400 V drives](#), columns “*EMC limits*” on page 290 to check the maximum motor cable lengths and the need for filters for 400 V drives for IEC/EN 61800-3 compliance.



**WARNING!** Do not use RFI/EMC filters on IT systems.

## Brake components

### Availability

Braking availability for ACS550 drives, by frame size is:

- R1 and R2 – a built-in brake chopper is standard equipment. Add appropriate resistor, as determined using the following section. Resistors are available from ABB.
- R3...R6 – does not include an internal brake chopper. Connect a chopper and a resistor, or a brake unit to the DC link terminals on the drive. Contact your ABB representative for appropriate parts.

### Selecting the braking resistors (frame sizes R1 and R2)

Braking resistor must meet three requirements:

- Resistance must be always higher than the minimum value  $R_{MIN}$  defined for the drive type in the following tables. Never use resistance below this value.
- Resistance must be low enough to be able to produce the desired braking torque. To achieve the maximum braking torque (the larger of 150% of heavy duty or 110% of nominal duty), the resistance must not exceed  $R_{MAX}$ . If maximum braking torque is not necessary, resistor values can exceed  $R_{MAX}$ .
- The resistor power rating must be high enough to dissipate the braking power. This requirement involves many factors:
  - the maximum continuous power rating for the resistor(s)
  - the rate at which the resistor changes temperature (resistor thermal time constant)
  - maximum braking time ON – If the regeneration (braking) power is larger than the resistor rated power, there is a limit to the ON time, or the resistor overheats before the OFF period begins.
  - minimum braking time OFF – If the regeneration (braking) power is larger than the resistor rated power, the OFF time must be large enough for the resistor to cool between ON periods.

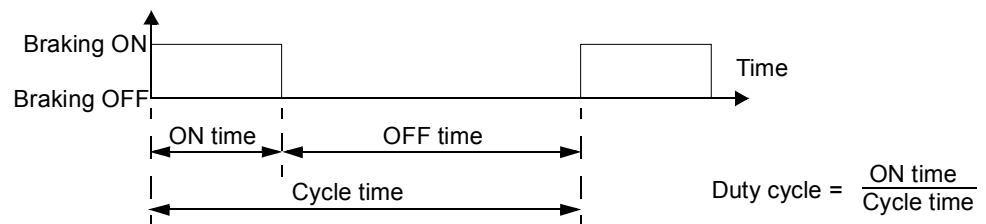

- the peak braking power requirement
- type of braking (deceleration to zero vs. overhauling load) – During deceleration to zero, the generated power steadily decreases, averaging half of the peak power. For an overhauling load, the braking is countering an external force (gravity for example) and the braking power is constant. The total heat generated from an overhauling load is double the heat generated from deceleration to zero speed (for the same peak torque and ON time).

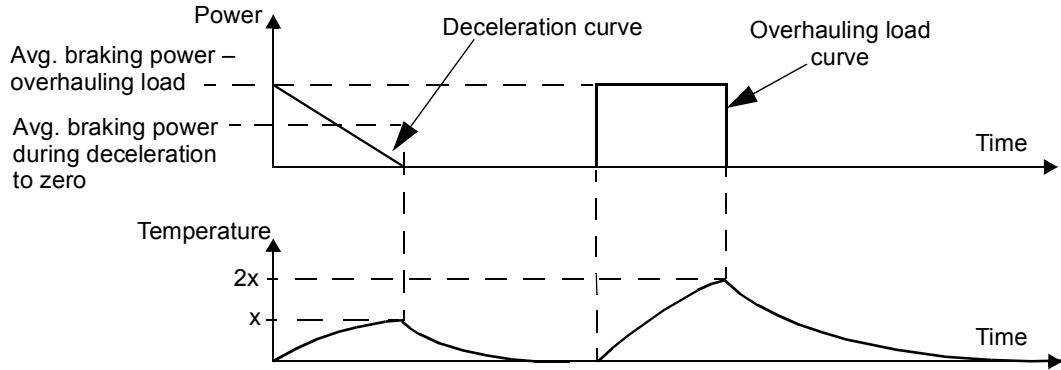

The many variables in the last requirement above are most easily dealt with using the following tables.

- First, determine your maximum braking time ON ( $ON_{MAX}$ ), minimum braking time OFF ( $OFF_{MIN}$ ) and load type (deceleration or overhauling load).
- Calculate duty cycle:

$$\text{Duty cycle} = \frac{ON_{MAX}}{(ON_{MAX} + OFF_{MIN})} \cdot 100\%$$

- In the appropriate table, find the column that best matches your data:
  - $ON_{MAX} \leq$  column specification and
  - Duty cycle  $\leq$  column specification
- Find the row that matches your drive.
- The minimum power rating for deceleration to zero is the value in the selected row/column.
- For overhauling loads, double the rating in the selected row/column, or use the “Continuous ON” column.

**208...240 V drives**

Type ACS550-01/U1- see below	Resistance		Resistor <sup>1</sup> minimum continuous power rating				
	$R_{MAX}$	$R_{MIN}$	Deceleration-to-zero rating				$P_{Rcont}$ Continuous ON > 60 s ON > 25% Duty
			$P_{R3}$ ≤ 3 s ON ≥ 27 s OFF ≤ 10% Duty	$P_{R10}$ ≤ 10 s ON ≥ 50 s OFF ≤ 17% Duty	$P_{R30}$ ≤ 30 s ON ≥ 180 s OFF ≤ 14% Duty	$P_{R60}$ ≤ 60 s ON ≥ 180 s OFF ≤ 25% Duty	
	ohm	ohm	W	W	W	W	W
Three-phase supply voltage, 208...240 V							
-04A6-2	234	80	45	80	120	200	1100
-06A6-2	160	80	65	120	175	280	1500
-07A5-2	117	44	85	160	235	390	2200
-012A-2	80	44	125	235	345	570	3000
-017A-2	48	44	210	390	575	950	4000
-024A-2	32	30	315	590	860	1425	5500
-031A-2	23	22	430	800	1175	1940	7500

<sup>1</sup> Resistor time constant specification must be ≥ 85 seconds.



**380...480 V drives**

Type ACS550- 01/U1- see below	Resistance		Resistor <sup>1</sup> minimum continuous power rating				
	$R_{MAX}$	$R_{MIN}$	Deceleration-to-zero rating				$P_{rcont}$ Continuous ON > 60 s ON > 25% Duty
			$P_{r3}$ ≤ 3 s ON ≥ 27 s OFF ≤ 10% Duty	$P_{r10}$ ≤ 10 s ON ≥ 50 s OFF ≤ 17% Duty	$P_{r30}$ ≤ 30 s ON ≥ 180 s OFF ≤ 14% Duty	$P_{r60}$ ≤ 60 s ON ≥ 180 s OFF ≤ 25% Duty	
	ohm	ohm	W	W	W	W	W
Three-phase supply voltage, <b>380...480 V</b>							
-03A3-4	641	120	65	120	175	285	1100
-04A1-4	470	120	90	160	235	390	1500
-05A4-4	320	120	125	235	345	570	2200
-06A9-4	235	80	170	320	470	775	3000
-08A8-4	192	80	210	400	575	950	4000
-012A-4	128	80	315	590	860	1425	5500
-015A-4	94	63	425	800	1175	1950	7500
-023A-4	64	63	625	1175	1725	2850	11000

<sup>1</sup> Resistor time constant specification must be ≥ 85 seconds.

**500...600 V drives**

Type ACS550- U1- see below	Resistance		Resistor <sup>1</sup> minimum continuous power rating				
	$R_{MAX}$	$R_{MIN}$	Deceleration-to-zero rating				$P_{rcont}$ Continuous ON > 60 s ON > 25% Duty
			$P_{r3}$ ≤ 3 s ON ≥ 27 s OFF ≤ 10% Duty	$P_{r10}$ ≤ 10 s ON ≥ 50 s OFF ≤ 17% Duty	$P_{r30}$ ≤ 30 s ON ≥ 180 s OFF ≤ 14% Duty	$P_{r60}$ ≤ 60 s ON ≥ 180 s OFF ≤ 25% Duty	
	ohm	ohm	W	W	W	W	W
Three-phase supply voltage, <b>500...600 V</b>							
-02A7-6	548	80	93	175	257	425	1462
-03A9-6	373	80	137	257	377	624	2144
-06A1-6	224	80	228	429	629	1040	3573
-09A0-6	149	80	342	643	943	1560	5359
-011A-6	110	60	467	877	1286	2127	7308
-017A-6	75	60	685	1286	1886	3119	10718

<sup>1</sup> Resistor time constant specification must be ≥ 85 seconds.



**WARNING!** Never use a brake resistor with a resistance below the minimum value specified for the particular drive. The drive and the internal chopper are not able to handle the overcurrent caused by the low resistance.

**Symbols**

$R_{MIN}$  – Minimum allowed resistance of the braking resistor.

$R_{MAX}$  – Maximum resistance allowed if maximum braking torque is necessary.

$P_{rx}$  – Duty-cycle based resistor power rating in deceleration braking, where “x” is  $ON_{MAX}$  time.

### Installing and wiring resistors

All resistors must be installed outside the drive module in a place where they can dissipate heat.



**WARNING!** The surface temperature of the resistor is very high, and air flowing from the resistor is very hot. Materials near the brake resistor must be non-flammable. Provide protection from accidental contact with the resistor.

To ensure that the input fuses protect the resistor cable, use resistor cables with the same rating as used for the power input to the drive.

The maximum length of the resistor cable(s) is 10 m (33 ft). See section [Power connection diagrams](#) on page 25 for the resistor cable connection points.

### Mandatory circuit protection

The following setup is essential for safety – it interrupts the main supply in fault situations involving chopper shorts:

- Equip the drive with a main contactor.
- Wire the contactor so that it opens if the resistor thermal switch opens (an overheated resistor opens the contactor).

Below is a simple wiring diagram example.

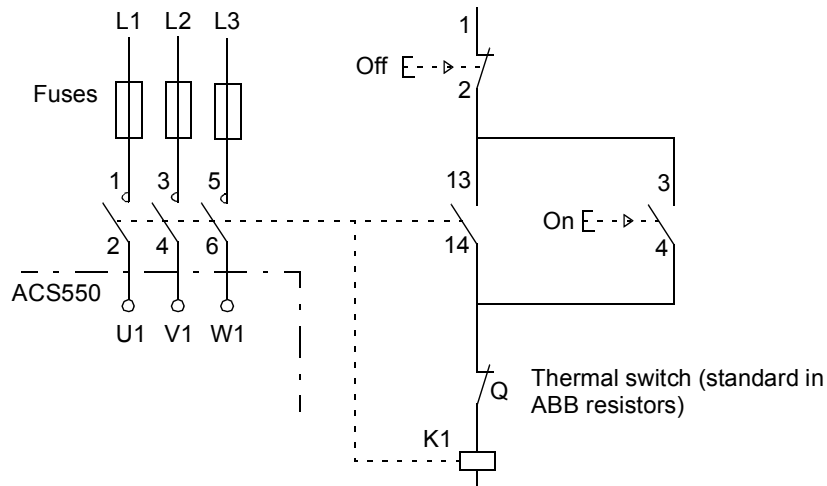

### Parameter set-up

To enable dynamic braking, switch off the drive's overvoltage control [Set parameter 2005 = 0 (DISABLE)].

## Control connections

### Control connection specifications

Control connection specifications	
<b>Analog inputs and outputs</b>	See section <a href="#">Control terminals table</a> on page 28.
<b>Digital inputs</b>	Digital input impedance 1.5 kohm. Maximum voltage for digital inputs is 30 V.
<b>Relays (digital outputs)</b>	<ul style="list-style-type: none"> <li>• Max. contact voltage: 30 V DC, 250 V AC</li> <li>• Max. contact current / power: 6 A, 30 V DC; 1500 VA, 250 V AC</li> <li>• Max. continuous current: 2 A rms (<math>\cos \varphi = 1</math>), 1 A rms (<math>\cos \varphi = 0.4</math>)</li> <li>• Minimum load: 500 mW (12 V, 10 mA)</li> <li>• Contact material: Silver-nickel (AgN)</li> <li>• Isolation between relay digital outputs, test voltage: 2.5 kV rms, 1 minute</li> </ul>
<b>Cable specifications</b>	See section <a href="#">Control terminals table</a> on page 28.

### Control cables

#### General recommendations

Use multi-core cables with a braided copper wire shield, temperature rated at 60 °C (140 °F) or above:

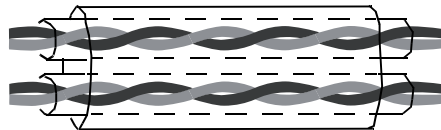

Double shielded  
Example: JAMAK by Draka NK Cables

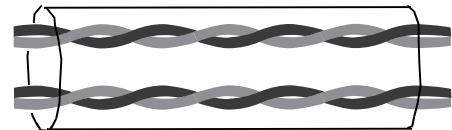

Single shielded  
Example: NOMAK by Draka NK Cables

For digital and analog I/O cables, twist the shield together into a bundle (pig-tail) not longer than five times its width and connect it to terminal X1-1 at the drive end. Leave the other end of the cable shield unconnected.

For connecting the shield wires of the RS485 cable, see the instructions (and notes) in section [Mechanical and electrical installation – EFB](#) on page 204.

Route control cables to minimize radiation to the cable:

- Route as far away as possible from the input power and motor cables (at least 20 cm [8 in]).
- Where control cables must cross power cables, make sure they are at an angle as near 90° as possible.
- Stay at least 20 cm (8 in) from the sides of the drive.

Use care in mixing signal types on the same cable:

- Do not mix relay-controlled signals using more than 30 V and other control signals in the same cable.
- Run relay-controlled signals as twisted pairs (especially if voltage > 48 V). Relay-controlled signals using less than 48 V can be run in the same cables as digital input signals.

---

**Note:** Never mix 24 V DC and 115/230 V AC signals in the same cable.

---

### *Analog cables*

Recommendations for analog signal runs:

- Use double shielded, twisted pair cable.
- Use one individually shielded pair for each signal.
- Do not use a common return for different analog signals.

### *Digital cables*

Recommendation for digital signal runs: A double shielded cable is the best alternative, but single-shielded, twisted, multi-pair cable is also usable.

### *Control panel cable*

If the control panel is connected to the drive with a cable, use only Category 5 Patch ethernet cable. The maximum length that is tested to meet EMC specifications is 3 m (9.8 ft). Longer cables are susceptible to electromagnetic noise and must be user-tested to verify that EMC requirements are met. Where long runs are required (especially for runs longer than about 12 m [40 ft]), use a RS232/RS485 converter at each end and run RS485 cable.

### **Drive's control connection terminals**

The following table provides specifications for the drive's control terminals

Frame size	Control			
	Maximum wire size <sup>1</sup>		Tightening torque	
	mm <sup>2</sup>	AWG	N·m	lb·ft
All	1.5	16	0.4	0.3

<sup>1</sup> Values given for solid wires.  
For stranded wires, the maximum size is 1 mm<sup>2</sup>.

## **Efficiency**

Approximately 98% at nominal power level.

## Losses, cooling data and noise

Cooling specifications	
<b>Method</b>	Internal fan, flow direction from bottom to top.
<b>Requirement</b>	Free space above and below the ACS550 drive: 200 mm (8 in). Free space is not required on the drive's sides – ACS550 drives can be mounted side-by-side.

### Air flow, 208...240 V drives

The following table lists the requirements for the cooling air flow data for 208...240 V drives at full load in all ambient conditions listed in [Ambient conditions](#) on page 307.

Drive		Heat dissipation		Air flow		Noise
ACS550-x1-	Frame size	W	BTU/hr	m <sup>3</sup> /h	ft <sup>3</sup> /min	dB
-04A6-2	R1	55	189	44	26	52
-06A6-2	R1	73	249	44	26	52
-07A5-2	R1	81	276	44	26	52
-012A-2	R1	118	404	44	26	52
-017A-2	R1	161	551	44	26	52
-024A-2	R2	227	776	88	52	66
-031A-2	R2	285	973	88	52	66
-046A-2	R3	420	1434	134	79	67
-059A-2	R3	536	1829	134	79	67
-075A-2	R4	671	2290	280	165	75
-088A-2	R4	786	2685	280	165	75
-114A-2	R4	1014	3463	280	165	75
-143A-2	R6	1268	4431	405	238	77
-178A-2	R6	1575	5379	405	238	77
-221A-2	R6	1952	6666	405	238	77
-248A-2	R6	2189	7474	405	238	77

00467918.xls C

### Air flow, 380...480 V drives

The following table lists the requirements for the cooling air flow data for 380...480 V drives at full load in all ambient conditions listed in [Ambient conditions](#) on page 307.

Drive		Heat dissipation		Air flow		Noise
ACS550-x1-	Frame size	W	BTU/hr	m <sup>3</sup> /h	ft <sup>3</sup> /min	dB
-03A3-4	R1	40	137	44	26	52
-04A1-4	R1	52	178	44	26	52
-05A4-4	R1	73	249	44	26	52
-06A9-4	R1	97	331	44	26	52
-08A8-4	R1	127	434	44	26	52
-012A-4	R1	172	587	44	26	52

Drive		Heat dissipation		Air flow		Noise
ACS550-x1-	Frame size	W	BTU/hr	m <sup>3</sup> /h	ft <sup>3</sup> /min	dB
-015A-4	R2	232	792	88	52	66
-023A-4	R2	337	1151	88	52	66
-031A-4	R3	457	1561	134	79	67
-038A-4	R3	562	1919	134	79	67
-045A-4	R3	667	2278	134	79	67
-059A-4	R4	907	3098	280	165	75
-072A-4	R4	1120	3825	280	165	75
-078A-4	R4	1295	4423	250	147	75
-087A-4	R4	1440	4918	280	165	75
-097A-4	R4	1440	4918	280	165	75
-125A-4	R5	1940	6625	350	205	75
-157A-4	R6	2310	7889	405	238	77
-180A-4	R6	2810	9597	405	238	77
-195A-4	R6	3050	10416	405	238	77
-246A-4	R6	3260	11134	405	238	77
-290A-4	R6	3850	13125	405	238	77

00467918.xls C

#### Air flow, 500...600 V drives

The following table lists the requirements for the cooling air flow data for 500...600 V drives at full load in all ambient conditions listed in [Ambient conditions](#) on page 307.

Drive		Heat dissipation		Air flow		Noise
ACS550-U1-	Frame size	W	BTU/hr	m <sup>3</sup> /h	ft <sup>3</sup> /min	dB
-02A7-6	R2	52	178	88	52	66
-03A9-6	R2	73	249	88	52	66
-06A1-6	R2	127	434	88	52	66
-09A0-6	R2	172	587	88	52	66
-011A-6	R2	232	792	88	52	66
-017A-6	R2	337	1151	88	52	66
-022A-6	R3	457	1561	134	79	67
-027A-6	R3	562	1919	134	79	67
-032A-6	R4	667	2278	280	165	75
-041A-6	R4	907	3098	280	165	75
-052A-6	R4	1117	3815	280	165	75
-062A-6	R4	1357	4634	280	165	75
-077A-6	R6	2310	7889	405	238	77
-099A-6	R6	2310	7889	405	238	77
-125A-6	R6	2310	7889	405	238	77

Drive		Heat dissipation		Air flow		Noise
ACS550-U1-	Frame size	W	BTU/hr	m <sup>3</sup> /h	ft <sup>3</sup> /min	dB
-144A-6	R6	2310	7889	405	238	77

00467918.xls C

## Dimensions and weights

The dimensions and mass for the ACS550 depend on the frame size and enclosure type. If unsure of the frame size, first, find the “Type” designation on the drive labels (see sections *The labels contain information on the Type designation (page 17)*, *Ratings and frame size (page 17)*, *Serial number (page 17)*, *degree of protection (see also Degrees of protection on page 306)* and *valid markings (see also Markings on page 309)* on page 17 and *Drive labels* on page 16). Then look up that type designation in the rating tables (see chapter *Technical data*, page 277), to determine the frame size.

### Mounting dimensions

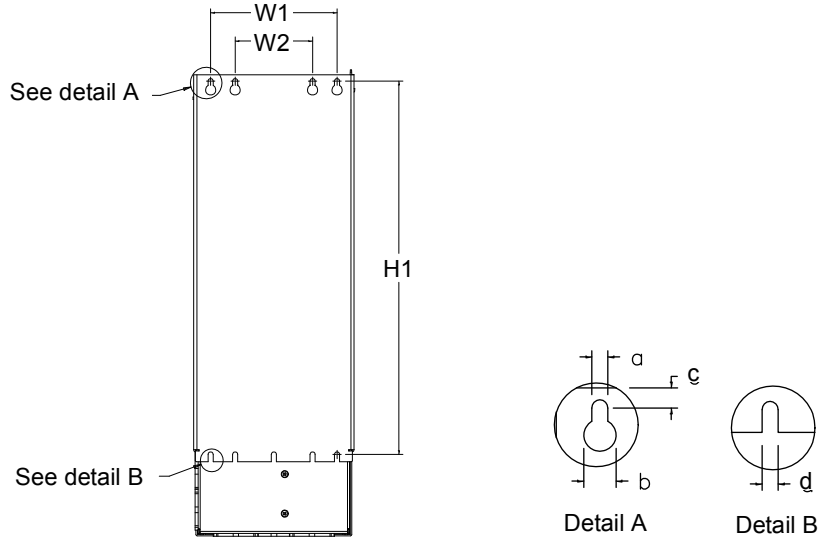

X0032

IP21 / UL type 1 and IP54 / UL type 12 – Dimensions for each frame size												
Ref.	R1		R2		R3		R4		R5		R6	
	mm	in	mm	in	mm	in	mm	in	mm	in	mm	in
<b>W1<sup>1</sup></b>	98.0	3.9	98.0	3.9	160	6.3	160	6.3	238	9.4	263	10.4
<b>W2<sup>1</sup></b>	--	--	--	--	98.0	3.9	98.0	3.9	--	--	--	--
<b>H1<sup>1</sup></b>	318	12.5	418	16.4	473	18.6	578	22.8	588	23.2	675	26.6
<b>a</b>	5.5	0.2	5.5	0.2	6.5	0.25	6.5	0.25	6.5	0.25	9.0	0.35
<b>b</b>	10.0	0.4	10.0	0.4	13.0	0.5	13.0	0.5	14.0	0.55	18.0	0.71
<b>c</b>	5.5	0.2	5.5	0.2	8.0	0.3	8.0	0.3	8.5	0.3	8.5	0.3
<b>d</b>	5.5	0.2	5.5	0.2	6.5	0.25	6.5	0.25	6.5	0.25	9.0	0.35

<sup>1</sup> Center to center dimension.

**Outside dimensions**

*Drives with IP21 / UL type 1 enclosures*

Types ACS550-x1-221A-2, ACS550-x1-246A-4, ACS550-x1-248A-2, and ACS550-01-290A-4, frame size R6

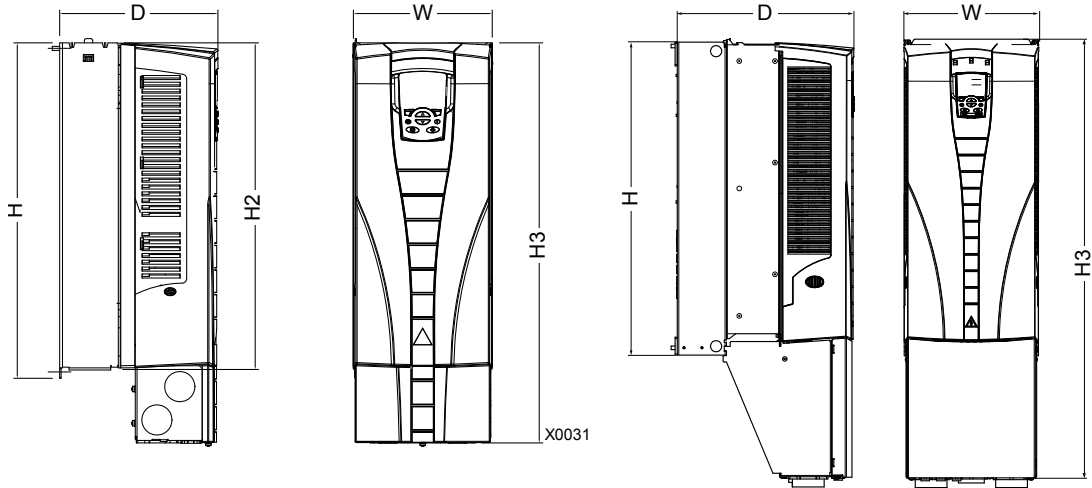

IP21 / UL type 1 – dimensions for each frame size												
Ref.	R1		R2		R3		R4		R5		R6	
	mm	in	mm	in	mm	in	mm	in	mm	in	mm	in
<b>W</b>	125	4.9	125	4.9	203	8.0	203	8.0	265	10.4	302	11.9
<b>H</b>	330	13.0	430	16.9	490	19.3	596	23.5	602	23.7	700	27.6
<b>H2</b>	315	12.4	415	16.3	478	18.8	583	23.0	578	22.8	698	27.5
<b>H3</b>	369	14.5	469	18.5	583	23.0	689	27.1	736	29.0	888 <sup>1</sup>	35.0 <sup>1</sup>
<b>D</b>	212	8.3	222	8.7	231	9.1	262	10.3	286	11.3	400	15.8

00467918.xls C

1. ACS550-x1-221A-2, ACS550-x1-246A-4, ACS550-x1-248A-2 and ACS550-x1-290A-4: 981 mm / 38.6 in.



Drives with IP54 / UL type 12 enclosures

Type ACS550-01-290A-4, IP54  
(UL type 12 not available), frame size R6

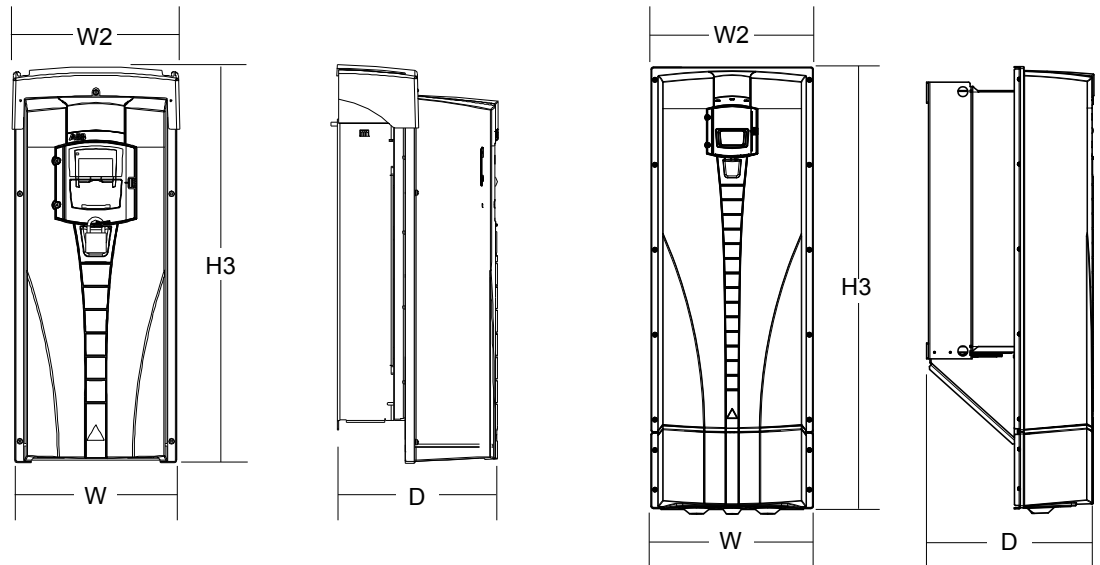

IP54 / UL type 12 – Dimensions for each frame size												
Ref.	R1		R2		R3		R4		R5		R6 <sup>2</sup>	
	mm	in	mm	in	mm	in	mm	in	mm	in	mm	in
<b>W</b>	213	8.4	213	8.4	257	10.1	257	10.1	369	14.5	410	16.1
<b>W2</b>	222	8.8	222	8.8	267	10.5	267	10.5	369	14.5	410	16.1
<b>H3</b>	461	18.2	561	22.1	629	24.8	760	29.9	775	30.5	924 <sup>1</sup>	36.4 <sup>1</sup>
<b>D</b>	234	9.2	245	9.7	254	10.0	284	11.2	309	12.2	423	16.7

00467918.xls C

1. ACS550-01-290A-4: 1119 mm / 44.1 in.
2. UL type 12 not available for ACS550-01-290A-4.

## Weight

The following table lists typical maximum weights for each frame size. Variations within each frame size (due to components associated with voltage/current ratings and options) are minor.

Enclosure	Weight											
	R1		R2		R3		R4		R5		R6	
	kg	lb	kg	lb	kg	lb	kg	lb	kg	lb	kg	lb
<b>IP21 / UL type 1</b>	6.5	14.3	9.0	19.8	16	35	24	53	34	75	69 <sup>1</sup>	152 <sup>1</sup>
<b>IP54 / UL type 12</b>	8.0	17.6	11.0	24.3	17.0	37.5	26.0	57.3	42.0	93.0	86.0 <sup>2</sup>	190 <sup>2</sup>

00467918.xls C

1. ACS550-x1-221A-2, IP21 / UL type 1: 70 kg / 154 lb  
 ACS550-x1-246A-4, IP21 / UL type 1: 70 kg / 154 lb,  
 ACS550-x1-248A-2, IP21 / UL type 1, 80 kg / 176 lb.  
 ACS550-01-290A-4, IP21 / UL type 1: 80 kg / 176 lb.
2. ACS550-x1-246A-4, IP54 / UL type 12: 80 kg / 176 lb  
 ACS550-01-290A-4, IP54: 90 kg / 198 lb (UL type 12 not available).

## Degrees of protection

Available enclosures:

- IP21 / UL type 1 enclosure. The site must be free of airborne dust, corrosive gases or liquids, and conductive contaminants such as condensation, carbon dust and metallic particles.
- IP54 / UL type 12 enclosure. This enclosure provides protection from airborne dust and light sprays or splashing water from all directions.

Note: UL type 12 enclosure is not available for type ACS550-01-290A-4.

Compared to the IP21 / UL type 1 enclosure, the IP54 / UL type 12 enclosure has:

- the same internal plastic shell as the IP21 enclosure
- a different outer plastic cover
- an additional internal fan to improve cooling
- larger dimensions
- the same rating (does not require a derating).

## Ambient conditions

The following table lists the ACS550 environmental requirements.

Ambient environment requirements		
	Installation site	Storage and transportation in the protective package
<b>Altitude</b>	<ul style="list-style-type: none"> <li>0...1000 m (0...3 300 ft)</li> <li>1000...2000 m (3 300...6 600 ft) if <math>P_N</math> and <math>I_{2N}</math> derated 1% every 100 m above 1000 m (300 ft above 3 300 ft)</li> </ul>	
<b>Ambient temperature</b>	<ul style="list-style-type: none"> <li>Min. -15 °C (5 °F) – no frost allowed</li> <li>Max. (fsw = 1 or 4) 40 °C (104 °F); 50 °C (122 °F) if <math>P_N</math> and <math>I_{2N}</math> derated to 90%</li> <li>Max. (fsw = 8) 40 °C (104 °F) if <math>P_N</math> and <math>I_{2N}</math> derated to 80%</li> <li>Max. (fsw = 12) 30 °C (86 °F) if <math>P_N</math> and <math>I_{2N}</math> derated to 65% (to 50% for 600 V, R4 frame sizes, that is for ACS550-U1-032A-6 ... ACS550-U1-062A-6)</li> </ul>	-40...70 °C (-40...158 °F)
<b>Relative humidity</b>	5...95%, no condensation allowed	
<b>Contamination levels (IEC 60721-3-3)</b>	<ul style="list-style-type: none"> <li>No conductive dust allowed.</li> <li>The ACS550 should be installed in clean air according to enclosure classification.</li> <li>Cooling air must be clean, free from corrosive materials and free from electrically conductive dust.</li> <li>Chemical gases: Class 3C2</li> <li>Solid particles: Class 3S2</li> </ul>	<b>Storage</b> <ul style="list-style-type: none"> <li>No conductive dust allowed.</li> <li>Chemical gases: Class 1C2</li> <li>Solid particles: Class 1S2</li> </ul> <b>Transportation</b> <ul style="list-style-type: none"> <li>No conductive dust allowed.</li> <li>Chemical gases: Class 2C2</li> <li>Solid particles: Class 2S2</li> </ul>

The following table lists the standard stress testing that the ACS550 passes.





Stress tests		
	Without shipping package	Inside shipping package
<b>Sinusoidal vibration</b>	Mechanical conditions: In accordance with IEC 60721-3-3, Class 3M4 <ul style="list-style-type: none"> <li>2...9 Hz 3.0 mm (0.12 in)</li> <li>9...200 Hz 10 m/s<sup>2</sup> (33 ft/s<sup>2</sup>)</li> </ul>	In accordance with ISTA 1A and 1B specifications.
<b>Shock</b>	Not allowed	In accordance with IEC 68-2-29: max. 100 m/s <sup>2</sup> (330 ft/s <sup>2</sup> ), 11ms
<b>Free fall</b>	Not allowed	<ul style="list-style-type: none"> <li>76 cm (30 in), frame size R1</li> <li>61cm (24 in), frame size R2</li> <li>46 cm (18 in), frame size R3</li> <li>31 cm (12 in), frame size R4</li> <li>25 cm (10 in), frame size R5</li> <li>15 cm (6 in), frame size R6</li> </ul>

## Materials

<b>Material specifications</b>	
<b>Drive enclosure</b>	<ul style="list-style-type: none"> <li>• PC/ABS 2.5 mm, color NCS 1502-Y or NCS 7000-N</li> <li>• Hot-dip zinc coated steel sheet 1.5...2 mm, thickness of coating 20 micrometers. If the surface is painted, the total thickness of the coating (zinc and paint) is 80...100 micrometers.</li> <li>• Cast aluminium AlSi</li> <li>• Extruded aluminium AlSi</li> </ul>
<b>Package</b>	Corrugated board, expanded polystyrene, plywood, raw wood (heat dried). Package wrap consists of one or more of the following: PE-LD plastic wrap, PP or steel bands.
<b>Disposal</b>	<p>The drive contains raw materials that should be recycled to preserve energy and natural resources. The package materials are environmentally compatible and recyclable. All metal parts can be recycled. The plastic parts can either be recycled or burned under controlled circumstances, according to local regulations. Most recyclable parts are marked with recycling marks.</p> <p>If recycling is not feasible, all parts excluding electrolytic capacitors and printed circuit boards can be landfilled. The DC capacitors contain electrolyte and, if the drive is not provided with the RoHS marking, the printed circuit boards contain lead, both of which are classified as hazardous waste within the EU. They must be removed and handled according to local regulations.</p> <p>For further information on environmental aspects and more detailed recycling instructions, contact your local ABB representative.</p>

## Applicable standards

Drive compliance with the following standards is identified by the standard “marks” on the type designation label. The following standards are applicable to the drive:

Mark	Applicable standards	
	EN 50178:1997	Electronic equipment for use in power installations
	IEC/EN 60204-1:2005	Safety of machinery. Electrical equipment of machines. Part 1: General requirements. <i>Provisions for compliance:</i> The final assembler of the machine is responsible for installing: <ul style="list-style-type: none"> <li>• an emergency-stop device</li> <li>• a supply disconnecting device.</li> </ul>
	IEC/EN 60529:1989 + A1:1999 + A2:2013	Degrees of protection provided by enclosures (IP code)
	IEC 60664-1:2002	Insulation coordination for equipment within low-voltage systems. Part 1: Principles, requirements and tests
	IEC/EN 61800-5-1:2007	Adjustable speed electrical power drive systems. Part 5-1: Safety requirements. Electrical, thermal and energy
	IEC/EN 61800-3:2004 +A1:2012	Adjustable speed electrical power drive systems. Part 3: EMC requirements and specific test methods
	IEC/EN 61000-3-12:2011	Electromagnetic compatibility (EMC). Part 3-12: Limits - Limits for harmonic currents produced by equipment connected to public low-voltage systems with input current > 16 A and = 75 A per phase
	IEC/EN 61800-3:2004 +A1:2012	Adjustable speed electrical power drive systems. Part 3: EMC requirements and specific test methods
	UL 508C	UL Standard for Safety, Power Conversion Equipment, third edition
	C22.2 No. 14	CSA Standard for Industrial Control Equipment (for ACS550-U1 drives only)

## Markings

### CE marking

 A CE mark is attached to the drive to verify that the drive follows the provisions of the European Low Voltage, EMC and RoHS Directives

**Note:** The 600 V ACS550-U1 drives are not CE approved.

### Compliance with the European Low Voltage Directive

The compliance with the European Low Voltage Directive has been verified according to standards IEC/EN 60204-1:2005 and EN 50178:1997.

### Compliance with the European EMC Directive

The Directive defines the requirements for immunity and emissions of electrical equipment used within the European Union. The EMC product standard IEC/EN 61800-3:2004 +A1:2012 covers requirements stated for drives.

### Compliance with IEC/EN 61800-3:2004 +A1:2012

See page [311](#).

### C-Tick marking



The drive carries C-Tick marking.

C-Tick marking is required in Australia and New Zealand. A C-Tick mark is attached to the drive to verify compliance with the relevant standard (IEC 61800-3:2004) – Adjustable speed electrical power drive systems – Part 3: EMC product standard including specific test methods), mandated by the Trans-Tasman Electromagnetic Compatibility Scheme.

The Trans-Tasman Electromagnetic Compatibility Scheme (EMCS) was introduced by the Australian Communication Authority (ACA) and the Radio Spectrum Management Group (RSM) of the New Zealand Ministry of Economic Development (NZMED) in November 2001. The aim of the scheme is to protect the radio frequency spectrum by introducing technical limits for emission from electrical/ electronic products.

### Compliance with IEC/EN 61800-3:004

See page [311](#).

### UL/CSA markings



An UL mark is attached to ACS550 drives to verify that the drive follows the provisions of UL 508C.



A CSA mark is attached to ACS550-**U1** type drives to verify that the drive follows the provisions of C22.2 NO. 14.

The ACS550 is suitable for use in a circuit capable of delivering not more than 100 kA RMS symmetrical amperes, 600 V maximum. The ampere rating is based on tests done according to UL 508.

Branch circuit protection must be provided in accordance with local codes.

The ACS550 has an electronic motor protection feature that complies with the requirements of UL 508C and, for ACS550-U1, C22.2 No. 14. When this feature is selected and properly adjusted, additional overload protection is not required unless more than one motor is connected to the drive or unless additional protection is required by applicable safety regulations. See parameters 3005 (MOT THERM PROT) and 3006 (MOT THERM RATE).

The drives are to be used in a controlled environment. See section [Ambient conditions](#) on page [307](#) for specific limits.

**Note:** For open type enclosures, i.e. drives without the conduit box and/or cover for IP21 / UL type 1 drives, or without the conduit plate and/or hood for IP54 / UL type 12 drives, the drive must be mounted inside an enclosure in accordance with National Electric Code and local electrical codes.

Brake choppers, when applied with appropriately sized brake resistors, will allow the drive to dissipate regenerative energy (normally associated with quickly decelerating a motor). Frame sizes R1 and R2 have a built-in brake chopper as standard

equipment. For frame sizes R3...R6, contact your local ABB representative for appropriate parts. See section [Brake components](#) on page 295.

### EAC marking



The drive has EAC certification. EAC marking is required in Russia, Belarus and Kazakhstan.

## IEC/EN 61800-3:2004 Definitions

EMC stands for **E**lectromagnetic **C**ompatibility. It is the ability of electrical/electronic equipment to operate without problems within an electromagnetic environment. Likewise, the equipment must not disturb or interfere with any other product or system within its locality.

*First environment* includes establishments connected to a low-voltage network which supplies buildings used for domestic purposes.

*Second environment* includes establishments connected to a network not directly supplying domestic premises.

*Drive of category C2*: drive of rated voltage less than 1000 V and intended to be installed and commissioned only by a professional when used in the first environment.

**Note:** A professional is a person or organization having necessary skills in installing and/or commissioning power drive systems, including their EMC aspects.

Category C2 has the same EMC emission limits as the earlier class first environment restricted distribution. EMC standard IEC/EN 61800-3 does not any more restrict the distribution of the drive, but the using, installation and commissioning are defined.

*Drive of category C3*: drive of rated voltage less than 1000 V, intended for use in the second environment and not intended for use in the first environment.

Category C3 has the same EMC emission limits as the earlier class second environment unrestricted distribution.

## Compliance with the IEC/EN 61800-3:2004 +A1:2012

The immunity performance of the drive complies with the demands of IEC/EN 61800-3, category C2 (see page 311 for IEC/EN 61800-3 definitions). The emission limits of IEC/EN 61800-3 comply with the provisions described below.

### First environment (drives of category C2)

1. The internal EMC filter is connected.
2. The motor and control cables are selected as specified in this manual.
3. The drive is installed according to the instructions given in this manual.
4. The motor cable length does not exceed the allowed maximum length specified in section [Motor cable length for 400 V drives](#) on page 290 for the frame size and switching frequency in use.

**WARNING!** In a domestic environment, this product may cause radio interference, in which case supplementary mitigation measures may be required.

### **Second environment (drives of category C3)**

1. The internal EMC filter is connected.
2. The motor and control cables are selected as specified in this manual.
3. The drive is installed according to the instructions given in this manual.
4. The motor cable length does not exceed the allowed maximum length specified in section [Motor cable length for 400 V drives](#) on page 290 for the frame size and switching frequency in use.

**WARNING!** A drive of category C3 is not intended to be used on a low-voltage public network which supplies domestic premises. Radio frequency interference is expected if the drive is used on such a network.

**Note:** It is not allowed to install a drive with the internal EMC filter connected on IT (ungrounded) systems. The supply network becomes connected to ground potential through the EMC filter capacitors, which may cause danger or damage the drive.

**Note:** It is not allowed to install a drive with the internal EMC filter connected to a corner grounded TN system as this would damage the drive.



# Index

<b>Numerics</b>	
0xxxx register	
EFB function codes . . . . .	218
EFB mapping . . . . .	216
1xxxx register	
EFB function codes . . . . .	219
EFB mapping . . . . .	218
2-wire sensor/transmitter, connection example . . . . .	86
3-wire macro . . . . .	79
3-wire sensor/transmitter, connection example . . . . .	86
3xxxx register	
EFB function codes . . . . .	219
EFB mapping . . . . .	219
4xxxx register	
EFB function codes . . . . .	222
EFB mapping . . . . .	219
<b>A</b>	
ABB	
document library . . . . .	325
feedback on ABB manuals . . . . .	325
product and service inquiries . . . . .	325
product training . . . . .	325
standard (default) macro . . . . .	78
acceleration	
/deceleration, parameter group . . . . .	139
at aux. stop (PFC), parameter . . . . .	200
compensation, parameter . . . . .	142
ramp select, parameter . . . . .	139
ramp shape, parameter . . . . .	139
ramp time (PFC), parameter . . . . .	200
ramp zero select, parameter . . . . .	140
time, parameter . . . . .	139
activate (external PID), parameter . . . . .	178
actual input (PID), parameters . . . . .	174
actual max. (PID), parameters . . . . .	174
actual min. (PID), parameters . . . . .	174
actual values	
mapping, FBA, generic profile . . . . .	257
scaling, EFB comm . . . . .	211
scaling, FBA comm . . . . .	244
scaling, FBA, ABB drives profile . . . . .	255
scaling, FBA, generic profile . . . . .	257
alarm	
codes . . . . .	267
codes (Basic Control Panel) . . . . .	269
display enable, parameter . . . . .	132
listing . . . . .	267
words, data parameters . . . . .	113
alternate macro . . . . .	80
altitude	
derating . . . . .	280
environment limit . . . . .	307
shipping limit . . . . .	307
ambient conditions . . . . .	307
ambient temperature	
derating . . . . .	280
environment limit . . . . .	307
shipping limit . . . . .	307
amplitude logging	
see load analyzer	
analog cable, requirements . . . . .	300
analog I/O	
connections . . . . .	28
specifications . . . . .	28
analog input	
parameter group . . . . .	123
data parameter . . . . .	109
fault limit, parameters . . . . .	150
filter, parameters . . . . .	123
less than min. auto. reset, parameter . . . . .	152
less than min., fault parameter . . . . .	148
loss, fault codes . . . . .	261
maximum, parameters . . . . .	123
minimum, parameters . . . . .	123
analog output	
parameter group . . . . .	127
content max., parameters . . . . .	127
content min., parameters . . . . .	127
current max., parameters . . . . .	127
current min., parameters . . . . .	127
data content, parameters . . . . .	127
data parameters . . . . .	109
filter, parameters . . . . .	127
obtain 0...10 V . . . . .	87
analyzer, load	
see load analyzer	
angle	
mechanical, data parameter . . . . .	110
application block output, data parameter . . . . .	108
application macro, parameter . . . . .	106
application macros	
see macros	
arrow (Assistant Control Panel) . . . . .	49
assistant (Assistant Control Panel)	
start-up . . . . .	57
tasks . . . . .	58
Assistant Control Panel	
see control panel (Assistant)	
assistants mode (Assistant Control Panel) . . . . .	57
autochange	
interval, parameter . . . . .	193
level, parameter . . . . .	194
overview . . . . .	194
starting order counter . . . . .	194
automatic reset	
see reset, automatic	
auxiliary motor	
see motor, auxiliary	

**B**

backing up parameters	
Assistant Control Panel	64
Basic Control Panel	75
Basic Control Panel	
see control panel (Basic)	
battery (Assistant Control Panel)	275
baud rate (RS-232), parameter	183
braking	
components	295
protection from overheated resistor	298
resistor heat dissipation	298
selecting brake choppers/resistors	295
wiring	298
break point frequency, fault parameter	149
buffer overruns (count), parameter	183

**C**

cable requirements	
control	299
grounding	285
input power	284
motor	292
capacitor	
reforming	275
replacement	275
category (IEC/EN 61800-3 definition)	
C2	311
C3	311
CB	
see control board	
CE marking	309
changed parameters (Assistant Control Panel)	60
chopper	
see braking	
clock	
see time and date setting (Assistant Control Panel)	
CO <sub>2</sub> conversion factor	
see energy saving	
communication	
see EFB (embedded fieldbus)	
see EFB, drive parameters	
see FBA (fieldbus adapter)	
see FBA, drive parameters	
compatibility	13
conduit kit	23
config file	
CPI firmware revision, parameter	182
fault code	263
id revision, parameter	182
revision, parameter	182
connections	
control	28
diagram	28
EFB comm	204
FBA module	240
X1	28
constant speed	
see speed, constant	
construction code	17

contamination levels	
environment limit	307
shipping limit	307
contrast, control panel (Assistant)	54
control	
connection specifications	299
location, data parameter	108
terminal specifications	300
through I/O interface	44
control board	
overtemperature, fault code	264
overtemperature, fault parameter	151
temperature, data parameter	110
control cable	
connections	28
requirements	299
control panel	
cable requirements	47
comm error, fault parameter	148
display bar-graph	156, 157
display decimal point (form), parameters	156
display max., parameters	157
display min., parameters	157
display process variables, parameter group	156
display selection, parameters	156
display units, parameters	157
maintenance	275
manual compatibility	47
parameter lock, parameter	129
pass code, parameter	129
reference control, parameter	117
signal max., parameters	156
signal min., parameters	156
control panel (Assistant)	48
arrow	49
assistants mode	57
battery	275
changed parameters mode	60
direction of rotation	49, 53
display contrast	54
fault logger mode	61
fault mode	49, 259, 260
help	51
how to do common tasks	50
I/O settings mode	67
main menu	50
operation	49
output mode	53
overview	48
parameter backup mode	64
parameters mode	55
soft keys	48
start/stop	52
status line (LOC/REM, arrow)	49
time and date mode	62

control panel (Basic) . . . . . 68  
 alarm codes . . . . . 269  
 copy mode . . . . . 75  
 direction of rotation . . . . . 68, 70  
 fault mode . . . . . 69, 259, 260  
 how to do common tasks . . . . . 69  
 main menu . . . . . 69  
 operation . . . . . 69  
 output mode . . . . . 71  
 overview . . . . . 68  
 parameter mode . . . . . 73  
 reference mode . . . . . 72  
 start/stop . . . . . 70  
 control word  
 ABB drives, FBA, description . . . . . 248  
 EFB, description . . . . . 224  
 FBA . . . . . 238  
 FBA generic profile . . . . . 256  
 cooling  
 air flow . . . . . 301  
 fan maintenance triggers . . . . . 147  
 heat dissipation . . . . . 301  
 space requirement . . . . . 301  
 copy mode (Basic Control Panel) . . . . . 75  
 corner grounded TN system . . . . . 285  
 warning about filters . . . . . 6  
 warning about screws at EM1, EM3 . . . . . 25  
 warning about screws at F1, F2 . . . . . 26  
 correction source (PID), parameter . . . . . 179  
 cover  
 remove . . . . . 21  
 replace . . . . . 36  
 cover, top, see hood  
 CRC errors (count), parameter . . . . . 183  
 crimp-on ring lugs . . . . . 287  
 critical speeds (avoiding)  
 parameter group . . . . . 144  
 high, parameters . . . . . 144  
 low, parameters . . . . . 144  
 select, parameter . . . . . 144  
 C-Tick marking . . . . . 310  
 current  
 at fault, history parameter . . . . . 114  
 data parameter . . . . . 108  
 max. limit, parameter . . . . . 133  
 measurement, fault code . . . . . 262  
 rating code . . . . . 17

**D**

date  
 see time and date setting (Assistant Control Panel)  
 DC  
 brake time, parameter . . . . . 137  
 bus voltage, data parameter . . . . . 108  
 current ref., parameter . . . . . 137  
 magnetizing time, parameter . . . . . 136  
 overvoltage, fault code . . . . . 261  
 undervoltage, fault code . . . . . 261  
 voltage stabilizer, parameter . . . . . 146

deceleration  
 parameter group . . . . . 139  
 at aux. start (PFC), parameter . . . . . 200  
 emergency time, parameter . . . . . 140  
 ramp select, parameter . . . . . 139  
 ramp shape, parameter . . . . . 139  
 ramp time (PFC), parameter . . . . . 200  
 ramp zero select, parameter . . . . . 140  
 time, parameter . . . . . 139  
 default values  
 listing for macros . . . . . 89  
 listing for parameters . . . . . 91  
 derating  
 adjustment example . . . . . 280  
 altitude . . . . . 280  
 single phase supply . . . . . 280  
 switching frequency . . . . . 280  
 temperature . . . . . 280  
 derivation time (PID), parameter . . . . . 171  
 derivation time, parameter . . . . . 141  
 device overtemperature, fault code . . . . . 261  
 diagnostics . . . . . 259  
 EFB comm . . . . . 212  
 FBA comm . . . . . 245  
 digital cable requirements . . . . . 300  
 digital input  
 at fault, history parameters . . . . . 114  
 connections . . . . . 28  
 specifications . . . . . 29  
 status, data parameter . . . . . 109  
 digital output  
 connections . . . . . 28  
 specifications . . . . . 299  
 dimensions  
 drive, mounting . . . . . 303  
 drive, outside . . . . . 304  
 DIP switches . . . . . 25, 28  
 direction control, parameter . . . . . 116  
 direction of rotation  
 Assistant Control Panel . . . . . 49, 53  
 Basic Control Panel . . . . . 68, 70  
 display format (PID), parameter . . . . . 171  
 disposal . . . . . 308  
 document library . . . . . 325  
 download parameter sets  
 application . . . . . 64  
 full set . . . . . 64  
 user sets . . . . . 64  
 drive  
 EFB comm installation . . . . . 204  
 FBA module installation . . . . . 240  
 id, fault code . . . . . 263  
 mounting . . . . . 22  
 mounting dimensions . . . . . 303  
 outside dimensions . . . . . 304  
 rating, parameter . . . . . 155  
 temperature, data parameter . . . . . 108  
 weight . . . . . 306  
 drive on time, data parameters . . . . . 110

**E**

EAC marking . . . . . 311

earth fault			
detection level	151	efficiency	300
fault code	262	ELV (Extra Low Voltage)	29
parameter	150	EM1 and EM3 screws	
earthing		location	25
see ground		on corner grounded TN system	27
EFB (embedded fieldbus)	203	on IT systems	27
actual value scaling	211	on symmetrically grounded TN systems	27
actual values	211	warning	25, 285, 286
analog output control, activate	209	embedded fieldbus	
comm fault response	210	see EFB	
configuration	206	see EFB, drive parameters	
configure for loss of communication	213	EMC	
control interface	203	CE marking	309
control word	224	C-Tick marking	310
diagnostics	212	motor cable requirements	293
drive control of functions, activate	207	EMC filter, external	286
exception codes	223	EMC filter, internal	27, 285, 286, 311, 312
fault code 28	214	emergency	
fault code 31	214	deceleration time, parameter	140
fault code 32	214	stop devices	283
fault code 33	214	stop select, parameter	137
fault tracing parameters	212	enclosure	
fault, duplicate stations	213	protection class code	17
fault, intermittent off-line	214	types	306
fault, no master station on line	213	encoder	
fault, swapped wires	213	parameter group	181
feedback from drive	211	enable, parameter	181
input reference sel., activate	208	error, fault code	263
installation	204	fault, parameter	181
misc. drive control, activate	208	number of pulses, parameter	181
modbus actual values	223	position reset enable, parameter	181
PID control setpoint source, activate	210	zero pulse detected, data parameter	110
planning	204	zero pulse enable, parameter	181
profiles	216	energy saving	
reference scaling, ABB drives profile	233	parameter group	180
reference scaling, DCU profile	233	CO2 conversion factor, parameter	180
relay output control, activate	209	energy price, parameter	180
set-up	205	energy reset, parameter	180
start/stop/direction control, activate	207	pump power, parameter	180
state diagram	232	saved amount 1, data parameter	111
status word	227	saved amount 2, data parameter	111
termination	205	saved CO2, data parameter	111
EFB, drive parameters	184	saved kWh, data parameter	111
protocol, parameter group	184	saved MWh, data parameter	111
baud rate, parameter	184	error value inversion (PID), parameter	171
command words, data parameters	112	exception codes, EFB modbus	223
config file, fault code	263	external comm module, parameter group	
control profile, parameter	184	see FBA, drive parameters	
CRC errors (count), parameter	184	external commands selection, parameter	115
fault codes	263	external control selection, parameter	117
fault function, parameter	150	external fault	
fault time, parameter	150	automatic reset, parameter	152
ok messages (count), parameter	184	fault codes	262
parameters	184, 185	parameters	148
parity, parameter	184	external reference, data parameter	108
protocol id, parameter	184		
protocol select, parameter	201		
relay output word, data parameter	109		
station id, parameter	184		
status words, data parameters	112		
status, parameter	184		
UART errors (count), parameter	184		
values, data parameter	109		

**F**

- F1 and F2 screws
  - location . . . . . 26
  - on corner grounded TN system. . . . . 27
  - on IT systems . . . . . 27
  - on symmetrically grounded TN systems . . . . . 27
  - warning . . . . . 26, 285, 286
- fan
  - control . . . . . 132
  - maintenance . . . . . 272, 274
- fault
  - functions, parameter group . . . . . 148
  - history, parameter group . . . . . 114
  - codes . . . . . 260
  - comm failure (EFB) . . . . . 210
  - current at, history parameter . . . . . 114
  - digital input status at, history parameter . . . . . 114
  - FBA comm . . . . . 244
  - frequency at, history parameter . . . . . 114
  - history . . . . . 266
  - last, history parameter . . . . . 114
  - listing . . . . . 260
  - logging (Assistant Control Panel) . . . . . 61
  - mode (Assistant Control Panel) . . . . . 49, 259, 260
  - mode (Basic Control Panel) . . . . . 69, 259, 260
  - previous, history parameter . . . . . 114
  - reset . . . . . 132, 265
  - reset select, parameter . . . . . 129
  - speed at, history parameter . . . . . 114
  - status at, history parameter . . . . . 114
  - time of, history parameters . . . . . 114
  - torque at, history parameter . . . . . 114
  - voltage at, history parameter . . . . . 114
  - words, data parameters . . . . . 113
- fault display
  - alarm . . . . . 260
  - fault . . . . . 259
  - fault names . . . . . 260
- FB actual signals, parameter group . . . . . 112
- FBA
  - protocol listing . . . . . 237
- FBA (fieldbus adapter) . . . . . 237
  - actual values . . . . . 239
  - analog output control, activate . . . . . 243
  - comm fault response . . . . . 244
  - configuration . . . . . 241
  - control word . . . . . 238
  - control word, ABB drives . . . . . 248
  - diagnostics . . . . . 245
  - drive feedback . . . . . 244
  - fieldbus control, activate . . . . . 241
  - input reference sel., activate . . . . . 242
  - installation . . . . . 240
  - PID control setpoint source, activate . . . . . 244
  - planning . . . . . 239
  - reference . . . . . 239
  - relay output control, activate . . . . . 243
  - set-up . . . . . 241
  - start/stop /direction control, activate . . . . . 241
  - state diagram, ABB drives . . . . . 251
  - status word . . . . . 239
  - status word, ABB drives . . . . . 249
- FBA, drive parameters . . . . . 182
  - ext comm module parameter group . . . . . 182
  - command words, data parameters . . . . . 112
  - config file CPI firmware revision, parameter . . . . . 182
  - config file id revision, parameter . . . . . 182
  - config file revision, parameter . . . . . 182
  - fault function, parameter . . . . . 150
  - fault time, parameter . . . . . 150
  - fieldbus appl. program revision, parameter . . . . . 182
  - fieldbus CPI firmware revision, parameter . . . . . 182
  - fieldbus parameter refresh, parameter . . . . . 182
  - fieldbus parameters . . . . . 182
  - fieldbus status, parameter . . . . . 182
  - fieldbus type, parameter . . . . . 182
  - protocol select, parameter . . . . . 201
  - relay output word, data parameter . . . . . 109
  - status words, data parameters . . . . . 112
  - values, data parameter . . . . . 109
- feedback
  - multiplier (PID), parameter . . . . . 173
  - on ABB manuals . . . . . 325
  - select (PID), parameter . . . . . 173
- field weakening point . . . . . 289
- fieldbus
  - see EFB (embedded fieldbus)
  - see EFB, drive parameters
  - see FBA (fieldbus adapter)
  - see FBA, drive parameters
- fieldbus adapter
  - see FBA
  - see FBA, drive parameters
- fieldbus, embedded
  - see EFB
  - see EFB, drive parameters
- firmware
  - compatibility . . . . . 13
  - panel, version . . . . . 47, 51
  - version, parameter . . . . . 66, 155
- first environment
  - (C2), compliance with IEC/EN 61800-3 . . . . . 311
  - (C2), motor cable length . . . . . 290
  - definition . . . . . 311
- flange mounting . . . . . 20
- FlashDrop
  - application macro, parameter . . . . . 106
  - connection . . . . . 25
  - parameter view, parameter . . . . . 132
- floating network
  - see IT system
- flux braking, parameter . . . . . 145
- flux optimization, parameter . . . . . 145
- force trip, fault code . . . . . 263
- frame errors (count), parameter . . . . . 183
- frame size . . . . . 277
- free fall, stress testing . . . . . 307
- frequency
  - at fault, history parameter . . . . . 114
  - max. limit, parameter . . . . . 134
  - min. limit, parameter . . . . . 134
  - motor, resolution . . . . . 289
  - motor, specification . . . . . 289
  - switching, parameter . . . . . 146

fuses			
208...240 V drives	282		
380...480 V drives	282		
500...600 V drives	283		
<b>G</b>			
gain (PID), parameter	170		
generic profile, FBA			
actual value mapping	257		
actual value scaling	257		
overview	256		
reference scaling	256		
technical data	256		
gland kit	23		
ground			
cable/wire requirements	285		
fault protection	292		
<b>H</b>			
hand-auto macro	82		
heat dissipation	301		
hood (IP54 / UL type 12)	21, 36		
how to do common tasks			
with Assistant Control Panel	50		
with Basic Control Panel	69		
<b>I</b>			
I/O settings (Assistant Control Panel)	67		
I/O, control through	44		
id run			
fail, fault code	262		
parameter	107		
performing	45		
identification magnetization	107		
IEC ratings			
see ratings			
impedance grounded network			
see IT system			
incompatible software, fault code	264		
information on the Internet	325		
information, parameter group	155		
input power			
cable/wire requirements	284		
disconnecting device (disconnecting means)	281		
specifications	281		
input power connection			
IT system	286		
lugs for R6	287		
terminal size	286		
torque	286		
installation			
check list	35		
compatibility	18		
environment	18		
flow chart	15		
location	19		
mounting drive	22		
preparation	16		
procedures	15		
tools	18		
wiring overview	23		
insulation check	30		
integration time (PID), parameter	171		
integration time, parameter	141		
interlocks, parameter	195		
internal setpoint (PID), parameter	173		
Internet, information on	325		
IR compensation			
frequency, parameter	145		
parameters	145		
voltage, parameter	145		
isolation, between AC power source and drive	281		
IT system			
connections	286		
warning about filters	6, 294		
warning about screws at EM1, EM3	25		
warning about screws at F1, F2	26		
<b>J</b>			
jogging activation, parameter	116		
<b>K</b>			
keypad			
see control panel			
keypad reference select, parameter	117		
kWh			
counter, data parameter	108		
<b>L</b>			
label			
serial number	16		
type designation	16		
language, parameter	106		
LED			
on Assistant Control Panel	48, 259, 260		
on drive body	25, 259, 260		
library, document	325		
limits, parameter group	133		
load analyzer			
parameter group	186		
amplitude logger 1, distribution	187		
amplitude logger 2 signal base value, par...	186		
amplitude logger 2 signal, parameter	186		
amplitude logger 2, distribution	187		
loggers reset date	187		
loggers reset time	187		
loggers reset, parameter	186		
peak value logger filter time, parameter	186		
peak value logger signal, parameter	186		
peak value logger, current at peak value	187		
peak value logger, detected peak value	186		
peak value logger, frequency at peak value	187		
peak value logger, peak value date	186		
peak value logger, peak value time	186		
peak value logger, voltage at peak value	187		
load curve, see user load curve			
load frequency, see user load curve			
load torque, see user load curve			
loading package version, parameter	155		
LOC (local control)			
indication on Assistant Control Panel	49		
indication on Basic Control Panel	68		



mounting			
dimensions	303		
flange	20		
template	20		
multimotor systems	136, 146, 279, 289		
MWh			
counter, data parameter	110		
power consumption, maintenance trigger	147		
<b>N</b>			
NEMA ratings			
see ratings			
noise	301		
random sw. freq. parameter	146		
NPN	29		
<b>O</b>			
offset (PID), parameter	178		
ok messages (count), parameter	183		
operating data, parameter group	108		
operation			
Assistant Control Panel	49		
Basic Control Panel	69		
OPEX link, fault code	262		
OPEX power, fault code	262		
options	17		
parameter group	201		
code	17		
output			
frequency, data parameter	108		
voltage, data parameter	108		
wiring, fault code	263		
output mode			
Assistant Control Panel	53		
Basic Control Panel	71		
overcurrent			
automatic reset, parameter	152		
fault code	260		
overload curve			
see user load curve			
overmodulation	146		
overspeed, fault code	263		
overvoltage			
control enable, parameter	133		
<b>P</b>			
panel communication, parameter group	183		
panel display variables, parameter group	156		
panel firmware version	47, 51		
panel loss, fault code	261		
parameter			
analog input scale, fault code	264		
analog output scale, fault code	264		
change lock	129		
descriptions	106		
external relay output, fault code	265		
fieldbus, fault code	265		
hz rpm, fault code	264		
listing (ranges, resolutions, defaults)	91		
PCU 1 (power control unit), fault code	265		
PCU 2 (power control unit), fault code	265		
PFC IO, fault code	265		
PFC mode, fault code	265		
PFC ref. neg., fault code	264		
save changes	130		
table version, parameter	155		
user load curve, fault code	265		
view, parameter	132		
parameter mode			
Assistant Control Panel	55		
Basic Control Panel	73		
parameter restore			
Assistant Control Panel	64		
Basic Control Panel	75		
parity			
(RS-232), parameter	183		
errors (count), parameter	183		
PE earth			
earth fault, parameter	150		
PE earth connection			
terminal size	286		
torque	286		
peak value logging			
see load analyzer			
PELV (Protective Extra Low Voltage)	29		
PFC			
control, parameter group	189		
acceleration time, parameter	200		
aux start order, parameter	200		
aux. motor start delay, parameter	191		
aux. motor stop delay, parameter	191		
deceleration time, parameter	200		
enable, parameter	199		
low frequency, parameters	191		
macro	84		
number of aux. motors, parameter	192		
number of motors parameter	200		
reference step, parameters	189		
start delay, parameter	199		
start frequency, parameters	190		



PID		
process sets, parameter groups	169	
external / trimming, parameter group	178	
0% (actual signal), parameter	172	
100% (actual signal), parameter	172	
actual input select, parameters	174	
actual value max., parameters	174	
actual value min., parameters	174	
adjustment procedure	170	
comm value 1, data parameter	111	
comm value 2, data parameter	111	
control macro	83	
correction source, parameter	179	
decimal point (actual signal), parameter	171	
derivation filter, parameter	171	
derivation time, parameter	171	
deviation, data parameter	109	
error feedback inversion, parameter	171	
external source activate, parameter	178	
feedback multiplier, parameter	173	
feedback select, parameter	173	
feedback, data parameter	109	
gain, parameter	170	
integration time, parameter	171	
internal setpoint, parameter	173	
offset, parameter	178	
output, data parameter	109	
parameter set select, parameter	176	
scaling (0...100%), parameters	172	
setpoint maximum, parameter	173	
setpoint minimum, parameter	173	
setpoint select, parameter	172	
setpoint source, EFB comm activate	210	
setpoint source, FBA comm, activate	244	
setpoint, data parameter	109	
sleep delay, parameter	175	
sleep level, parameter	175	
sleep selection, parameter	174	
trim mode, parameter	178	
trim scale, parameter	178	
units (actual signal), parameter	171	
wake-up delay, parameter	175	
wake-up deviation, parameter	175	
PID controller		
advanced set-up	170	
basic set-up	169	
planning		
EFB comm	204	
FBA comm	239	
PNP	29	
power		
consumption (MWh) maintenance trigger	147	
data parameter	108	
previous faults, history parameters	114	
process PID sets, parameter groups	169	
process variables, data parameter	110	
product		
inquiries	325	
training	325	
profiles, EFB comm	216	
proportional gain, parameter	141	
protection		
circuit, required w/ chopper	298	
disconnecting device (disconnecting means)	281	
enclosure standard	309	
environmental	306	
motor thermal	291	
PT100 temperature sensor	160	
PTC temperature sensor	160	
pump power		
see energy saving		
<b>R</b>		
radiation limits, conducted		
EN 61800-3	294	
ramp pair (accel/decel), parameter	139	
range listing for parameters	91	
ratings	277	
reference		
select, parameter group	117	
corrections for parameter values	118	
keypad control, parameter	117	
maximum, parameters	119	
minimum, parameters	119	
mode (Basic Control Panel)	72	
select source, parameter	117	
step (PFC), parameters	189	
reference scaling		
EFB, ABB Drives profile	233	
EFB, DCU profile	233	
FBA, ABB drives profile	252	
FBA, generic profile	256	
reference setting		
Assistant Control Panel	54	
Basic Control Panel	72	
regulator by-pass control, parameter	199	
relative humidity		
environment limit	307	
shipping limit	307	
relay output		
parameter group	124	
activation condition parameters	124	
off-delay, parameters	125	
on-delay, parameters	125	
status, data parameter	109	
relays, specifications	299	
REM (remote control)		
indication on Assistant Control Panel	49	
indication on Basic Control Panel	68	
remove cover	21	
reset, automatic		
parameter group	152	
analog input less than min., parameter	152	
delay time, parameter	152	
external fault, parameter	152	
number of trials, parameter	152	
overcurrent, parameter	152	
trial time, parameter	152	
undervoltage, parameter	152	
resolution listing for parameters	91	
resonance (avoiding)		
select, parameter	144	
revolution counter, data parameter	110	

revolutions, mechanical, data parameter . . . . .	110	specifications	
ring lugs . . . . .	287	control connections . . . . .	299
RS-232		input power . . . . .	281
baud rate, parameter . . . . .	183	mains . . . . .	281
parity, parameter . . . . .	183	speed	
station id, parameter . . . . .	183	and direction (signed), data parameter . . . . .	108
RS-232 counts		at fault, history parameter . . . . .	114
buffer overruns, parameter . . . . .	183	data parameter . . . . .	108
CRC errors, parameter . . . . .	183	max. limit, parameter . . . . .	133
frame errors, parameter . . . . .	183	min. limit, parameter . . . . .	133
ok messages, parameter . . . . .	183	speed control	
parity errors, parameter . . . . .	183	parameter group . . . . .	141
RS485 comm. . . . .	204	acceleration compensation, parameter . . . . .	142
run enable source select, parameter . . . . .	129	automatic tuning, parameter . . . . .	141, 142
run time		derivation time, parameter . . . . .	141
data parameter . . . . .	108, 110	integration time, parameter . . . . .	141
maintenance trigger . . . . .	147	proportional gain, parameter . . . . .	141
		vector: speed mode . . . . .	106
		speed, constant	
		parameter group . . . . .	120
		digital input selection parameter . . . . .	120
		parameters . . . . .	121
		stall	
		frequency, fault parameter . . . . .	150
		function, fault parameter . . . . .	150
		region . . . . .	150
		time, fault parameter . . . . .	150
		standards . . . . .	309
		C22.2 No. 14 . . . . .	309
		CE marking . . . . .	309
		CSA marking . . . . .	310
		C-Tick marking . . . . .	310
		EN 50178 . . . . .	309
		IEC 60664-1 . . . . .	309
		IEC/EN 60204-1 . . . . .	309
		IEC/EN 60529 . . . . .	309
		IEC/EN 61000-3-12 . . . . .	309
		IEC/EN 61800-3 . . . . .	309
		IEC/EN 61800-5-1 . . . . .	309
		UL 508C . . . . .	309
		UL marking . . . . .	310
		start	
		parameter group . . . . .	136
		aux. motor (PFC), parameters . . . . .	190
		aux. motor delay . . . . .	191
		control, EFB comm. . . . .	207
		control, FBA comm. . . . .	241
		DC magnetizing time, parameter . . . . .	136
		delay (PFC), parameter . . . . .	199
		delay, parameter . . . . .	138
		frequency (PFC), parameters . . . . .	190
		function, parameter . . . . .	136
		inhibit, parameter . . . . .	137
		select enable source, parameter . . . . .	131
		torque boost current, parameter . . . . .	137
		start mode	
		automatic . . . . .	136
		automatic torque boost . . . . .	136
		DC magnetizing . . . . .	136
		flying start . . . . .	136
		start/stop	
		parameter group . . . . .	136
		with Assistant Control Panel . . . . .	52
		with Basic Control Panel . . . . .	70
<b>S</b>			
safety . . . . .	5		
save changes parameter . . . . .	130		
saving, energy			
see energy saving			
scalar: frequency mode . . . . .	106		
scaling			
actual value, FBA, ABB drives profile . . . . .	255		
actual value, FBA, generic profile . . . . .	257		
actual values, EFB comm . . . . .	211		
reference, EFB, ABB drives profile . . . . .	233		
reference, EFB, DCU profile . . . . .	233		
reference, FBA, ABB drives profile . . . . .	252		
reference, FBA, generic profile . . . . .	256		
screw-on terminal lugs . . . . .	288		
s-curve ramp, parameter . . . . .	139		
second environment			
(C3), compliance with IEC/EN 61800-3 . . . . .	312		
(C3), motor cable length . . . . .	290		
definition . . . . .	311		
sensor type, parameter . . . . .	160		
sensorless vector control mode . . . . .	106		
serial 1 error (fault code 28) . . . . .	214		
serial 1 error, fault code . . . . .	263		
serial communication			
see EFB (embedded fieldbus)			
see EFB, drive parameters			
see FBA (fieldbus adapter)			
see FBA, drive parameters			
serial number . . . . .	16, 17		
service . . . . .	325		
setpoint maximum (PID), parameter . . . . .	173		
setpoint minimum (PID), parameter . . . . .	173		
setpoint select (PID), parameter . . . . .	172		
shock, stress testing . . . . .	307		
short circuit, fault code . . . . .	261		
single phase supply			
connection . . . . .	23		
derating . . . . .	280		
sleep selection (PID), parameter . . . . .	174		
slip compensation ratio, parameter . . . . .	146		
soft keys (Assistant Control Panel) . . . . .	48		



user parameter set	88
change control, parameter	130
download	64

## V

vector:	
speed mode	106
torque mode	106
version	
firmware	13
firmware, parameter	66, 155
loading package, parameter	155
panel firmware	47, 51
parameter table, parameter	155
vibration, stress testing	307
voltage	
at fault, history parameter	114
rating code	17
voltage/frequency ratio, parameter	145

## W

wake-up	
delay (PID), parameter	175
deviation (PID), parameter	175
warning	
automatic start up	7
dangerous voltages	5, 6
disconnecting device (disconnecting means)	7
ELV (Extra Low Voltage)	29
EM1, EM3, F1 and F2 screws	6
filter on corner grounded TN system	6
filter on IT system	6
high temperatures	5
listing	5
not field repairable	5, 6
parallel control connections	6
qualified installer	5
weight	306
wiring	
control	28
fault, parameter	151
installation	30
installation steps, IP21/cables	30
installation steps, IP21/conduit	32
installation steps, IP54/cables	33
installation steps, IP54/conduit	34
overview	23
requirements, general	23

## XYZ

zero pulse	
detected, data parameter	110
enable, parameter	181
zero speed	
delay, parameter	138
load, fault parameter	149

## **Further information**

### **Product and service inquiries**

Address any inquiries about the product to your local ABB representative, quoting the type designation and serial number of the unit in question. A listing of ABB sales, support and service contacts can be found by navigating to [www.abb.com/searchchannels](http://www.abb.com/searchchannels).

### **Product training**

For information on ABB product training, navigate to [www.abb.com/drives](http://www.abb.com/drives) and select *Training courses*.

### **Providing feedback on ABB Drives manuals**

Your comments on our manuals are welcome. Go to [www.abb.com/drives](http://www.abb.com/drives) and select *Document Library – Manuals feedback form (LV AC drives)*.

### **Document library on the Internet**

You can find manuals and other product documents in PDF format on the Internet. Go to [www.abb.com/drives](http://www.abb.com/drives) and select *Document Library*. You can browse the library or enter selection criteria, for example a document code, in the search field.

# Contact us

[www.abb.com/drives](http://www.abb.com/drives)

[www.abb.com/drivespartners](http://www.abb.com/drivespartners)

3AFE64804588 (3AUA0000001418) Rev H / EN

EFFECTIVE: 2014-07-04

SUPERSEDES: 3AFE64804588 (3AUA0000001418) Rev G 2009-07-07



3AFE64804588\_3AUA0000001418\_H